



安全に関する注意

コンデンサを使用するに当たり、使用環境、及び取り付け環境を確認の上、納入仕様書に規定した定格性能の範囲内でご使用下さい。

納入仕様書、添付注意事項の範囲を越えて使用しますと、ショート、オープン、発煙、発火に至る場合がありますので、定格性能の範囲内であることを確認願います。

尚、納入仕様書に記載のない項目、不明な内容については、必ずお問い合わせ下さい。

又、生命に影響を与える可能性がある装置、機器（生命維持装置、航空機用制御装置、自動車用制御装置等）に使用される場合にも必ずお問い合わせ下さい。

※本仕様書は、発行日より6ヶ月を経過して返却されなかった場合は、受領いただけなかったものと判断し、無効とさせていただきます事ご了承願います。



Cautions About Safety In Use of Capacitors

When using a capacitor, please use one within the range of values specified in the specification after checking the environments of using and mounting.

If used beyond the range specified in the specification or the attached cautions, it may lead to short circuit, open, smoking and firing.

Be sure to inquire of us as to the items which are not specified in the specification or are unclear to you.

Also, in case of using capacitors for such equipment or apparatus as may possibly affect human lives like life-support system, aircraft and automotive control systems, etc., please never fail to inquire of us as to further details.

If this specification is not returned within six months, we consider it not to be accepted by you and will make it null and void.

| | | |
|---------------|-------------------------------------|---------------------------|
| SPECIFICATION | METALLIZED POLYESTER FILM CAPACITOR | SPEC P S C 3 0 5 0 0 0 |
|---------------|-------------------------------------|---------------------------|

1. SCOPE

This specification defines general requirements for metallized polyester film capacitor MMC type (hereinafter called capacitor).

2. PARTS NUMBER CODE SYSTEM

| | | | | | | | | | | | | | | | | | | | | |
|---|---|---|--|---|---|---|---|---|---|---|---|---|---|---|---|---|---|---|---|---|
| M | M | C | | * | 0 | 2 | 5 | 0 | J | 1 | 0 | 4 | 0 | 0 | 0 | 0 | 0 | 0 | 0 | 0 |
|---|---|---|--|---|---|---|---|---|---|---|---|---|---|---|---|---|---|---|---|---|

Designation

MMC : Straight lead type

MMC F : Single-formed lead type

MMCC : Cutted lead type

MMC V : Automatic vertical insertion type (Formed lead type)

Internal use

Rated DC voltage

100, 250, 400, 450, 630, 1000, 1250V.DC

Tolerance on capacitance

J : $\pm 5\%$, K : $\pm 10\%$

Capacitance Code

Capacitance value shall be given by 3-digit figure of which unit used is expressed in pF.

The first 2 digits are significant figures of the capacitance value, the third digit to indicate the number of additional zeros to follow the significant figure.

⑥ Model code (Internal use)

| REVISIONS | SIGNATURE | DATE |
|-----------|---------------------------------|----------------------|
| | DESIGNED <i>Y. Ootashiro</i> | <i>April 1, 2011</i> |
| | CHECKED <i>M. Sasaki</i> | <i>April 1, 2011</i> |
| | APPROVED <i>H. Kawagoe</i> | <i>April 1, 2011</i> |

SPECIFICATION

METALLIZED POLYESTER FILM CAPACITOR

SPEC

P S C 3 0 5 0 0 0

Lead dimension / Packing mode

| Designation | Code | | | |
|-------------|---------|--------------|---------|--------------|
| MMC | 0 0 0 0 | | | |
| MMC F | Code | Lead spacing | Code | Lead spacing |
| | 0 0 5 0 | 5.0 mm | 0 1 5 0 | 1 5.0 mm |
| | 0 0 7 5 | 7.5 mm | 0 1 7 5 | 1 7.5 mm |
| | 0 1 0 0 | 1 0.0 mm | 0 2 2 5 | 2 2.5 mm |
| | 0 1 2 5 | 1 2.5 mm | 0 2 7 5 | 2 7.5 mm |
| MM C C | 0 0 5 0 | | | |
| MMC V | Code | Style | | |
| | 0 2 0 0 | 1, 5, 6 | | |
| | D 2 0 0 | 2 | | |
| | D 2 1 0 | 3 | | |

3. RATING

3.1 Operating Temperature Range : Operating temperature range to capacitors shall be $-40^{\circ}\text{C}\sim+105^{\circ}\text{C}$ (Voltage derating in case of over 85).

3.1.1 Maximum Operating Temperature : Maximum value of capacitor's surface temperature (ambient temperature+self heating temperature rise+radiation and conduction heat from other electric supply sources) at which capacitors shall be capable of applying continuously.

3.1.2 Minimum Operating Temperature : Minimum temperature range at which capacitors shall be capable of applying continuously.

3.2 Rated voltage : The rated voltage shall be continuously usable within a working temperature range, and there are 7 kinds of rated voltages - 100, 250, 400, 450, 630, 1000 and 1250V.DC. However, in the $+85$ to $+105^{\circ}\text{C}$ range, there is the need for voltage derating of $1.5\%/^{\circ}\text{C}$ as shown in the following graph.

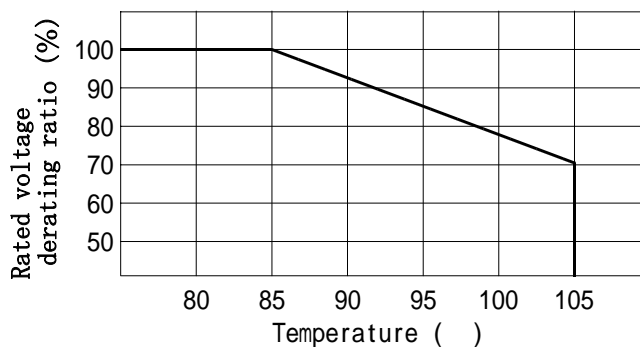

SPECIFICATION

METALLIZED POLYESTER FILM CAPACITOR

SPEC

P S C 3 0 5 0 0 0

3.3 Capacitance range

| | | |
|----------|-----------------------|------|
| 100V.DC | 0.033 ~ 4.7 μ F | E-12 |
| 250V.DC | 0.0010 ~ 10.0 μ F | E-12 |
| 400V.DC | 0.0010 ~ 4.7 μ F | E-12 |
| 450V.DC | 0.0010 ~ 3.3 μ F | E-12 |
| 630V.DC | 0.0010 ~ 2.2 μ F | E-12 |
| 1000V.DC | 0.0010 ~ 0.47 μ F | E-12 |
| 1250V.DC | 0.0010 ~ 0.22 μ F | E-12 |

3.4 Tolerance on capacitance

$\pm 5\%$, $\pm 10\%$

4. CONSTRUCTION OF CAPACITOR

Construction shall satisfy the provision of CF922 type of JIS C 5101-1:1998.

Capacitor shall be non-inductive wound construction with dielectric of metallized polyester film, and tinned copper wire or Sn-Cu plated copper wire shall be connected to capacitor element.

An exterior coating shall be given dampproofing and insulation treatments by using a flame-retardant epoxy resin (Recognized UL94V-0).

For the products of capacitance range 333~105, at 100V, tinned copper-covered steel wire shall be used.

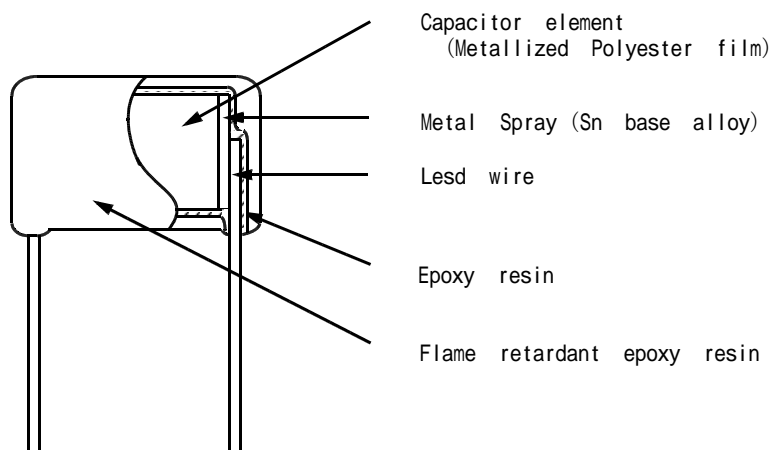

5. DIMENSIONS

Dimensions are specified in the attached sheet.

SPECIFICATION

METALLIZED POLYESTER FILM CAPACITOR

SPEC

P S C 3 0 5 0 0 0

6. MARKING

6.1 Marking item

The capacitors shall be marked clearly by an indelible way.

1) Rated capacitance

Shall be marked with 3-digit code. Exp) 333 , 104

2) Tolerance on rated capacitance

J or K

3) Production date code

| | | | | | | | | | | | | |
|---------------|---|---|---|---|---|---|---|---|---|-----|-----|-----|
| Month Year | 1 | 2 | 3 | 4 | 5 | 6 | 7 | 8 | 9 | 1 0 | 1 1 | 1 2 |
| Odd year | A | B | C | D | E | F | G | H | | | L | |
| Even year | N | P | Q | R | S | T | U | V | W | X | Y | Z |

4) Rated DC voltage

Unit code V is omitted.

5) Manufacturer's Identification

N I S

6.2 Marking position

(Example)

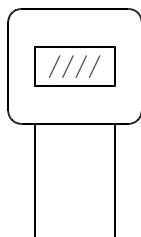

1 0 5 K 2 5 0
N I S A

| | | |
|---------------|-------------------------------------|-------------------|
| | | SPEC |
| SPECIFICATION | METALLIZED POLYESTER FILM CAPACITOR | P S C 3 0 5 0 0 0 |

7. PACKING

- 1) Straight leads, formed leads, double formed leads and cutted leads type.
The capacitors shall be put in poly-bag and packed in box marked with necessary information.

Inside packing case

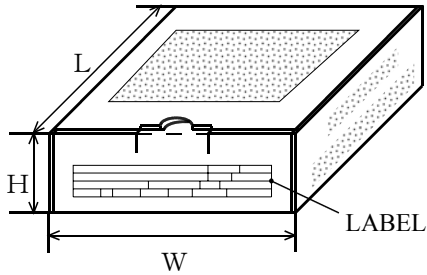

Dimension (mm)

| W | L | H |
|-------|-------|-----|
| 1 9 8 | 1 7 6 | 7 4 |

External packing case

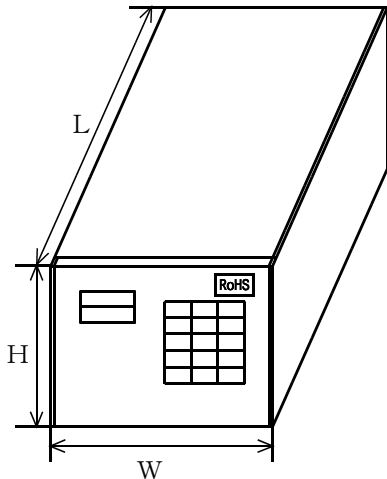

Dimension (mm)

| Inside packing case quantity | W | L | H |
|------------------------------|-------|-------|-------|
| 2 | 1 6 5 | 2 1 0 | 2 0 0 |
| 4 | 2 1 0 | 3 1 0 | " |
| 6 | 2 3 5 | 4 1 0 | " |
| 8 | 3 1 0 | 4 1 0 | " |
| 1 2 | 4 1 0 | 4 5 0 | " |

Example)
Example)

| | | | | | |
|---------------|----|-----------|---------|----------|---------|
| CODE CUSTOMER | | INSP DATE | | PKG NO | |
| PARTS NO | | | MACH NO | | QTY/PKG |
| ORDER NO | | LOT NO | | ROHS | |
| TYPE | WV | TOL | CAP | EDP CODE | |
| | | | | QT (PCS) | |

| | | | |
|---------------|----------|--------------------|----------|
| CODE CUSTOMER | MACH NO | PRODUCTION COUNTRY | TOL(%) |
| INSP DATE | ORDER NO | TYPE | CAP |
| PARTS NO | LOT NO | W V | EDP CODE |
| | | | QT(PCS) |

- 2) Automatic vertical insertion type.
This is specified by the specification of automatic vertical insertion type.

| SPECIFICATION | METALLIZED POLYESTER FILM CAPACITOR | SPEC P S C 3 0 5 0 0 0 |
|--|-------------------------------------|---------------------------|
| <p>8. APPLICABLE STANDARD Unless otherwise specified, performance and a testing method shall comply with JIS C 5101-1:1998.</p> <p>9. DISUSE OF O.D.C. No ozone depleting chemicals are used at any stage of the manufacturing process.</p> <p>10. DISUSE OF PBB0, PBDPO, PBDPE, PBBs This products does not contain PBB0, PBDPO, PBDPE, PBBs.</p> <p>11. CERTAIN HAZARDOUS SUBSTANCES RESTRICTED BY RoHS DIRECTIVE In the product, materials to which certain hazardous substances restricted by RoHS Directive (2002/95/EC) (cadmium, hexavalent chromium, mercury, lead, PBB and PBDE) are added on purpose aren't used.</p> <p>12. PRODUCTION COUNTRY • JAPAN • CHINA</p> <p>Production country shall be distinguished in the column .</p> <p>Example) JP : JAPAN blank : CHINA</p> | | |

| SPECIFICATION | METALLIZED POLYESTER FILM CAPACITOR | SPEC P S C 3 0 5 0 0 0 |
|--|--|---|
| <p>1 3. CHARACTERISTICS AND TEST CONDITIONS</p> <p>13.1 TEST CONDITIONS</p> <p>The test and measurement, unless otherwise specified, the standard range of atmospheric conditions for marking measurements and test is as follows</p> <p style="padding-left: 40px;">Ambient temperature : 5 to 35°C</p> <p style="padding-left: 40px;">Relative humidity : 45 to 85%</p> <p>If there may be anydoubt on the results, measurements shall be made within the following limits,</p> <p style="padding-left: 40px;">Ambient temperature : 20±2°C</p> <p style="padding-left: 40px;">Relative humidity : 60 to 75%</p> <p>13.2 Electrical characteristics test</p> | | |
| Item | Characteristics | Test conditions |
| Dielectric strength | Between terminations | Capacitors shall withstand 150% of rated DC voltage for 1 minute or 175% of rated DC voltage for 1~5 seconds. (Charge or discharge current : 1A max) |
| | Between termination and case | Capacitors shall withstand 200% of rated DC voltage for 1~5 seconds. |
| Insulation resistance (Between terminations) | $C \leq 0.33 \mu F$ 15,000M or more ----- $C > 0.33 \mu F$ 5,000 F or more | DC voltage specified below shall be applied for 1 minute, after which measurement shall be made. Test voltage : 100V.DC |
| Capacitance | Within the nominal tolerance. | Capacitance shall be measured with 1kHz±20%, 5Vrms max. |
| Tangent of loss angle | 0.008 or less | |

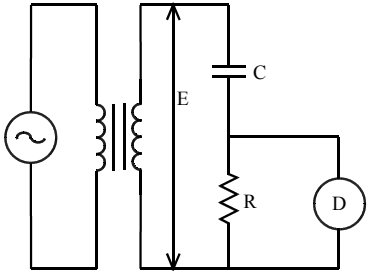
| SPECIFICATION | | METALLIZED POLYESTER FILM CAPACITOR | SPEC P S C 3 0 5 0 0 0 |
|--------------------------------------|---|---|---|
| Item | Characteristics | Test conditions | |
| Connection of element | There shall be no intermittent contacts or open circuiting which would result in any needle deflection on the voltage detector. | <p>As in the diagramed circuit measure the variation of terminal voltage for the series resistor(R) while a weak impact is made on the test capacitor to check the bonding strength of the terminals to the capacitor.</p>  <p>C : Capacitor R : Series resistor $R(\) = 150/C(\mu F)$ C=Nominal capacitance μF Ⓧ : Detector Internal impedance shall be large enough as compared with c. E : 100mV (peak value) Max at 10k~1MHz</p> | |
| 13.3 Mechanical characteristics test | | | |
| Item | Characteristics | Test conditions | |
| Termination strength | Tensile strength | Test capacitors shall be fixed, and unless otherwise specified, a tensile force of 10N shall be gradually applied to the axial of the leads, and then maintained for 30 ± 5 seconds. | |
| | Bending strength | Without mechanical damage, such as break of terminal damage. | <p>The bend test shall consist of hanging a weight of 5N to the end of the leads and then rotating the capacitors 90° in one direction, then to the starting point. This test shall be applied for 2.5 seconds per each time.</p> <p>At the same test speed, the capacitors shall be rotated 90° in alternating direction, then return to the starting point.</p> |

| SPECIFICATION | | METALLIZED POLYESTER FILM CAPACITOR | | SPEC P S C 3 0 5 0 0 0 | |
|------------------------------|--|--|--|--|--|
| Item | | Characteristics | | Test conditions | |
| Vibration resistance | | No electrical discontinuity such as opening, short-circuit of 0.5ms or more. Also, no abnormality on appearance after test. | | Capacitors shall be capable of withstanding without malfunctioning such as short, open circuit or a damage to a vibration test in three directions against perpendicularity at a frequency range from 10Hz to 55Hz. The frequency shall be varied uniformly from 10Hz to 55Hz at 1.5mm amplitude and back to 10Hz in approximately 1 minute intervals. This test shall be applied 2 hours per each direction, total 6 hours. | |
| Solderability | | At least 3/4 of the circumferential face of termination up to immersed level shall be covered with new solder. | | Capacitor's leads shall be immersed into Flux (10% rosin) for 5~10 seconds using sheltering board from radial test, then immersed into soldering bath at 230 ± 5 for 2 ± 0.5 seconds up to the depth of to the depth of 1.5~2mm from the bottom of the body. Immersed and removing speed shall be 25 ± 2.5 mm/sec. | |
| Resistance to soldering heat | Appearance | No visible damage. | | Using sheltering board from the radial heat, capacitor's leads shall be immersed into soldering bath at 260 ± 5 for 10 ± 1 seconds up to the depth of 1.5~2mm from the bottom of the body. The capacitors shall withstand 150% of rated DC voltage for 1 minute. | |
| | Dielectric strength (Between terminations) | No breakdown. | | | |
| | Capacitance change | Within $\pm 3\%$ of the initial value. | | | |
| 13.4 Climatic test | | | | | |
| Item | | Characteristics | | Test conditions | |
| Cold | Capacitance change | Within +0, -7% of the initial value. | | Measured at $-40 \pm 2^\circ\text{C}$. | |
| Dry heat | Insulation resistance | $C \leq 0.33 \mu\text{F}$ 900M or more ----- $C > 0.33 \mu\text{F}$ 300 F or more | | Measured at 85 ± 2 . | |
| | Capacitance change | Within +5, -2% of the initial value. | | | |

| SPECIFICATION | | METALLIZED POLYESTER FILM CAPACITOR | SPEC P S C 3 0 5 0 0 0 | |
|-------------------------------------|--|---|---|--|
| Item | Characteristics | Test conditions | | |
| Humidity resistance (steady state) | Appearance | No visible damage. | | |
| | Dielectric strength (Between terminations) | No breakdown. | | |
| | Insulation resistance | $C \leq 0.33 \mu\text{F}$ 2,700M or more | The capacitor shall be put into the test chamber and left under the condition of relative humidity 90~95% at $40 \pm 2^\circ\text{C}$ for 240 ± 8 hours. After the test, the capacitor shall be left under the ordinally condition for 16 hours. The capacitors shall withstand 130% of rated DC voltage for 1 minutes. | |
| | | $C > 0.33 \mu\text{F}$ 900 F or more | | |
| | Tangent of loss angle | 0.01 or less | | |
| Capacitance change | Within $\pm 7\%$ of the initial value. | | | |
| Endurance test for humidity | Appearance | No visible damage. | | |
| | Dielectric strength (Between terminations) | No breakdown. | | |
| | Insulation resistance | $C \leq 0.33 \mu\text{F}$ 2,700M or more | The rated voltage shall be continuously applied to the capacitor in the test chamber at a relative humidity of 90~95% at 40 ± 2 for $500 \pm 2\%$ hours. After the test, the capacitor shall be left under the ordinally condition for 1~2 hours. The capacitors shall withstand 130% of rated DC voltage for 1 minute. The load resistor in series with the capacitor shall be 20~1,000 . | |
| | | $C > 0.33 \mu\text{F}$ 900 F or more | | |
| | Tangent of loss angle | 0.01 or less | | |
| Capacitance change | Within $\pm 7\%$ of the initial value. | | | |
| Endurance test for high temperature | Appearance | No visible damage. | | |
| | Insulation resistance | $C \leq 0.33 \mu\text{F}$ 2,700M or more | The voltage of 125% of rated voltage shall be continuously applied to the capacitor through a series of 20~1,000 per 1 voltage in the test chamber at 85 ± 3 for $1,000 \pm 4\%$ hours. | |
| | | $C > 0.33 \mu\text{F}$ 900 F or more | | |
| | Tangent of loss angle | 0.01 or less | | |
| Capacitance change | Within $\pm 5\%$ of the initial value. | | | |

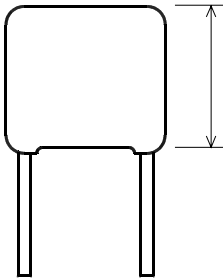
| SPECIFICATION | METALLIZED POLYESTER FILM CAPACITOR | SPEC P S C 3 0 5 0 0 0 |
|---|-------------------------------------|---------------------------|
| <p>1 4. SPECIAL STANDARD</p> <p>For rated voltage 1,000V and 1,250V, special standard described below shall be followed.</p> <p>14.1 Minimum thickness of the exterior coating</p> <p>For rated voltage 1,000V and 1,250V, thickness of the exterior coating shall be more than 0.3mm.</p> <p>The limit of the standard for the exterior coating of capacitors is shown below.</p> <div style="text-align: center;">  <p>Within the limit of the standard for thickness of the exterior coating. (more than 0.3mm)</p> </div> <p>14.2 Damp - proof insulation test :</p> <p>Capacitors shall be put in 40°C & 90~95%RH for 8 hours and then test at room temperature for 16 hours.</p> <p>After 5 cycles test, capacitors shall meet the requirements of the following test.</p> <p>(1) Dielectric Strength</p> <p>Between terminations : Applied 1,000V.AC for 1 minute. After the test, there shall be no dielectric breakdown or other damage.</p> <p>Between termination and case : Applied 1,500V.AC for 1 minute. After the test, there shall be no dielectric breakdown or other damage.</p> <p>(2) Insulation resistance</p> <p>Between terminations : More than 2,000M Between termination and case : More than 500M</p> <p>14.3 Dielectric Strength</p> <p>Between terminations : Applied 1,000V.AC for 1 minute. After the test, there shall be no dielectric breakdown or other damage.</p> <p>Between termination and case : Applied 1,500V.AC for 1 minute. After the test, there shall be no dielectric breakdown or other damage.</p> | | |

SPECIFICATION

METALLIZED POLYESTER FILM CAPACITOR

SPEC

P S C 3 0 5 0 0 0

15. REGULATION IN USAGE

15.1 Voltage derating for frequency

15.1.1 A.C.maximum operating voltage in case of operating with commercial frequency (50 or 60Hz) is as shown in the table below. However, it can not be used for "Across-the-line" application.

| Rated voltage | A.C.maximum operating voltage |
|----------------|-------------------------------|
| 1 0 0 V. D C | 6 3 V r m s |
| 2 5 0 V. D C | 1 2 5 V r m s |
| 4 0 0 V. D C | 2 0 0 V r m s |
| 4 5 0 V. D C | 2 0 0 V r m s |
| 6 3 0 V. D C | 2 5 0 V r m s |
| 1 0 0 0 V. D C | 4 0 0 V r m s |
| 1 2 5 0 V. D C | 5 0 0 V r m s |

15.1.2 When containing a portion of D.C.Bias, the crasy value (peak voltage V_{o-P}) waveform shall not exceed the rated voltage.

15.2 Permissible current to frequency

A permissible current is regulated by both a root-mean-square value current and a peak current. A root-mean-square value current is to be a permissible current value to frequency attached. A permissible peak current is determined by a permissible peak current value attached.

The values of continuous peak current in the allowable peak current shall be those of continuous current, and the values of single peak current shall be those of discontinuous current such as rush current in switching on or off. The highest number of times of single peak current shall be limited to 10,000 times. (In case of exceeding 10,000 times, please contact us.)

15.3 Permissible current to temperature

When operating in the range of $+85^{\circ}\text{C}\sim+105^{\circ}\text{C}$ with waveform except direct current, the value for characteristic of permissible current to frequency shown in Fig. shall be derated 1.5% at each 1°C .

15.4 Soldering

When soldering a capacitor, heat in soldering is conducted to the elements of the capacitor from lead wire and an enclosure, and hence it should be noted that soldering under high temperature and a long period may cause deterioration of characteristic or breakdown of capacitors.

Be sure to solder within the following temperature condition range.

(1) Flow soldering

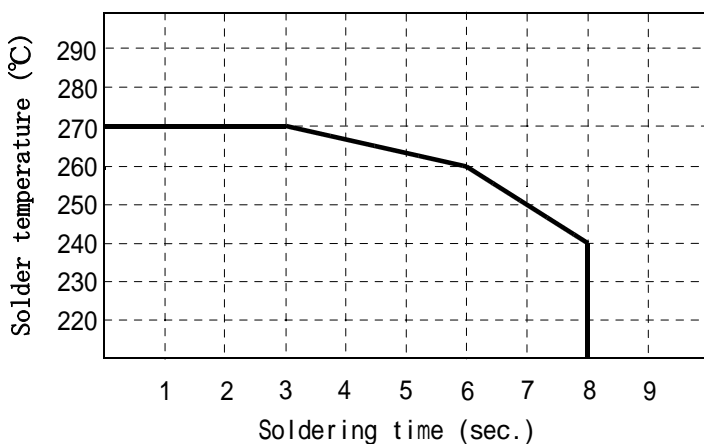

Preheating condition : 120°C,
for 90 seconds

(2) When using soldering iron

Iron tip temperature less than 350

Soldering time (sec.) within 5 seconds

(3) When soldering a capacitor mounted on the board with chip-type components

When applying the curing heat for fixing the chip components, the duration for which a capacitor is exposed to heat shall be within the permissible time, which changes according to the ambient temperature of the capacitor as shown in the annex.

周囲温度による許容さらし時間
Permissible time to be exposed to the ambient temperature

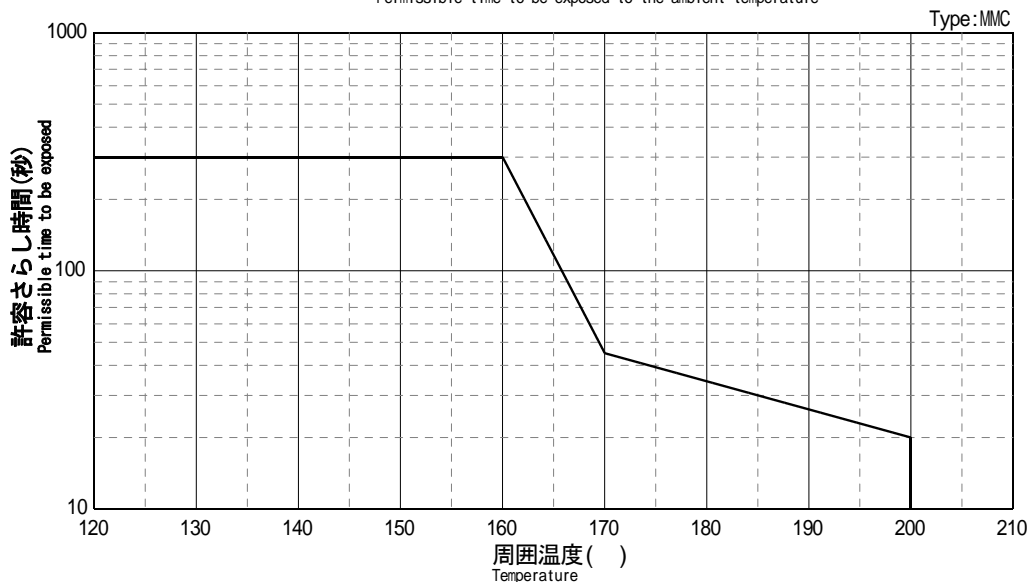

周波数に対する許容電流特性 (正弦波)

CHARACTERISTICS OF PERMISSIBLE CURRENT TO FREQUENCY (SINUSOIDAL WAVE)

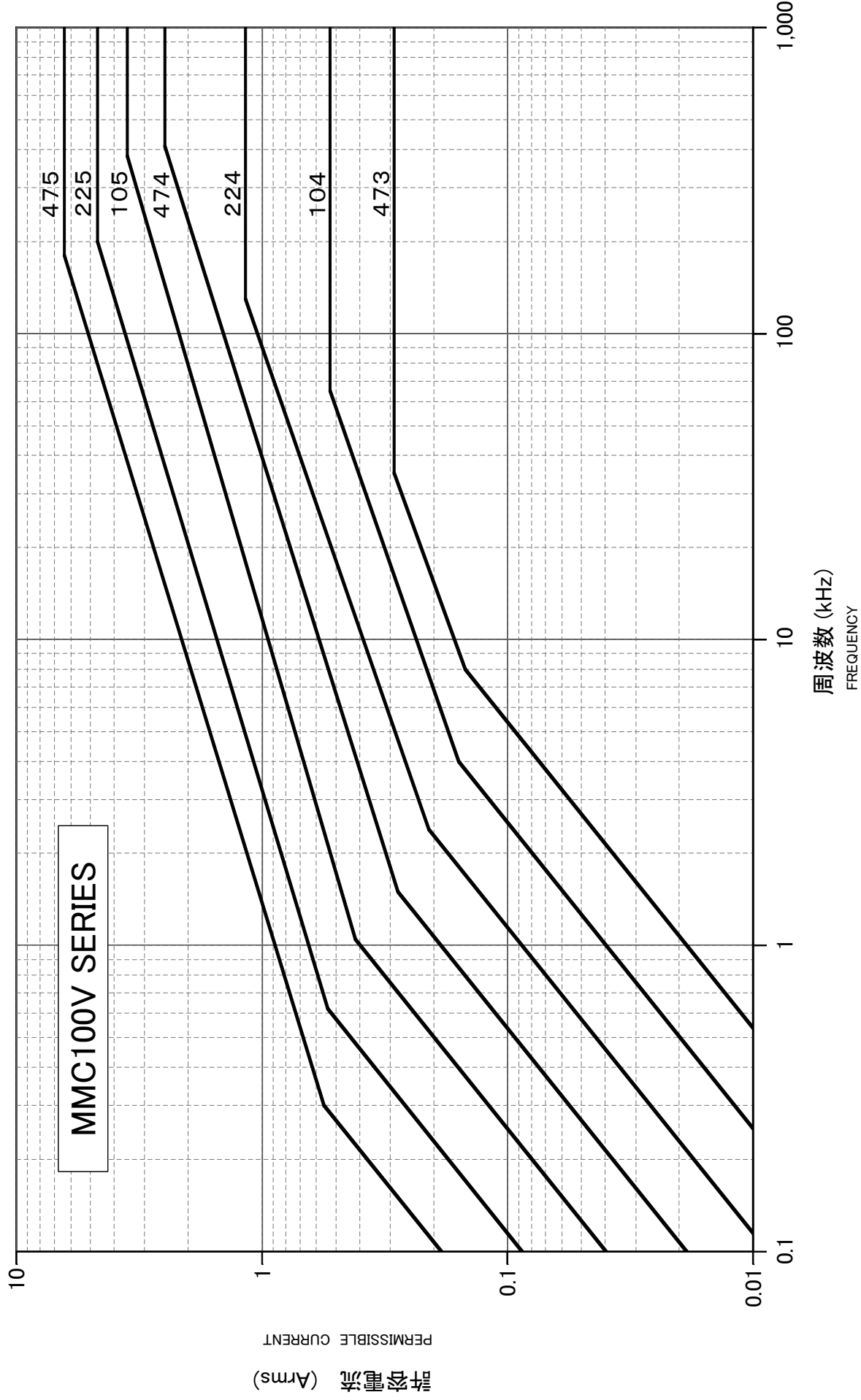

周波数に対する許容電流特性 (正弦波)

CHARACTERISTICS OF PERMISSIBLE CURRENT TO FREQUENCY (SINUSOIDAL WAVE)

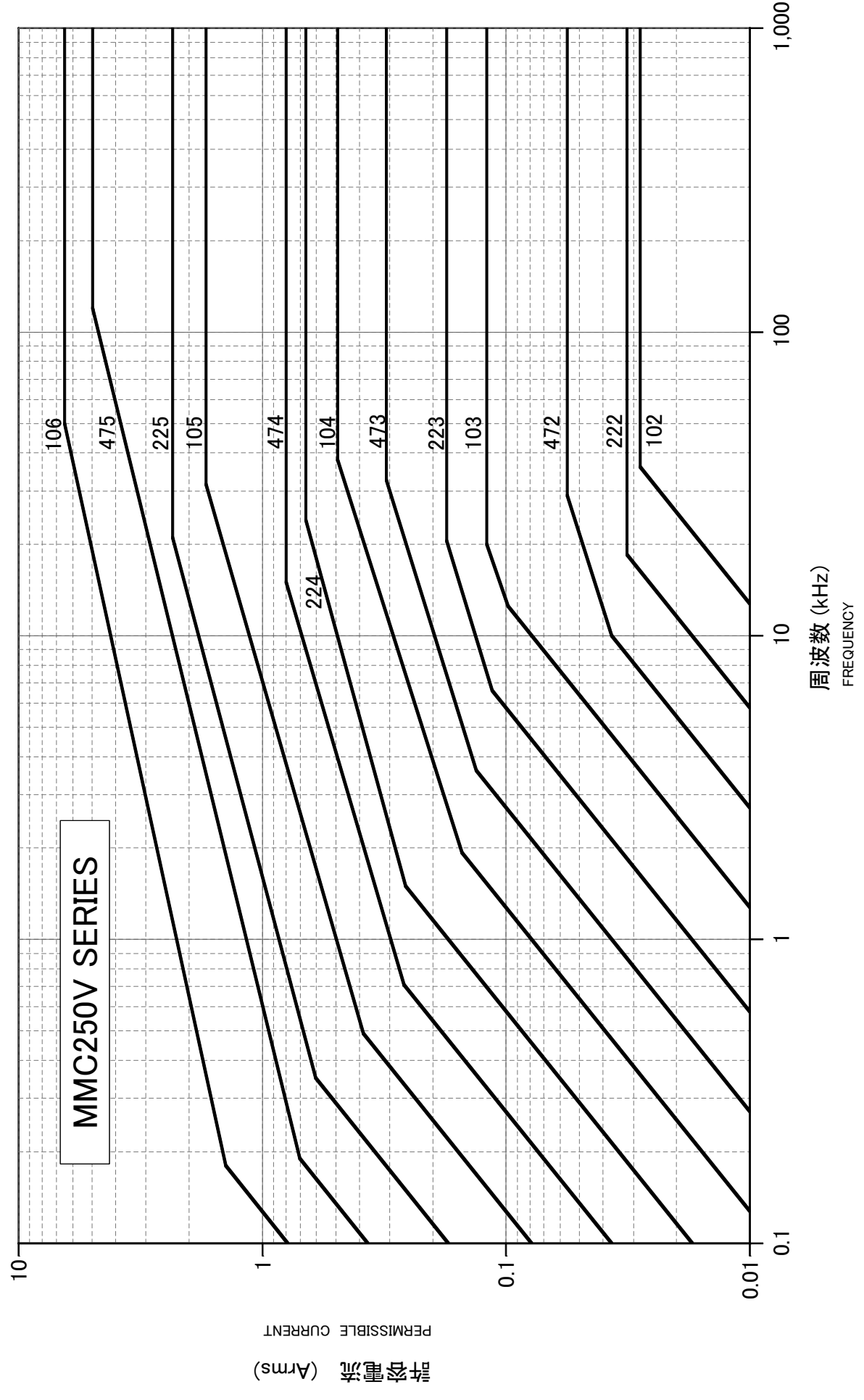

許容電流 (Arms)
PERMISSIBLE CURRENT

周波数 (kHz)
FREQUENCY

周波数に対する許容電流特性 (正弦波)

CHARACTERISTICS OF PERMISSIBLE CURRENT TO FREQUENCY (SINUSOIDAL WAVE)

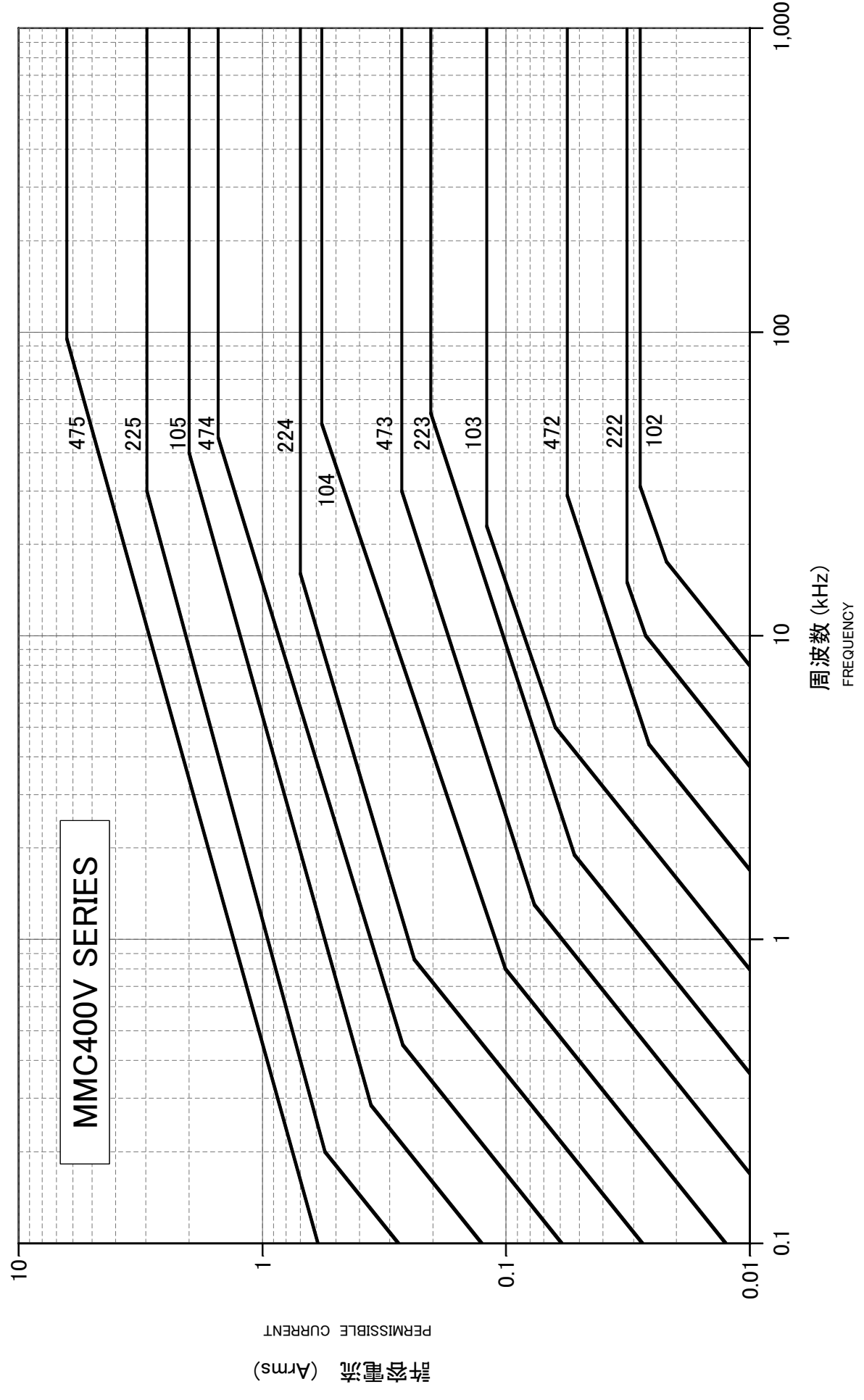

周波数に対する許容電流特性 (正弦波)

CHARACTERISTICS OF PERMISSIBLE CURRENT TO FREQUENCY (SINUSOIDAL WAVE)

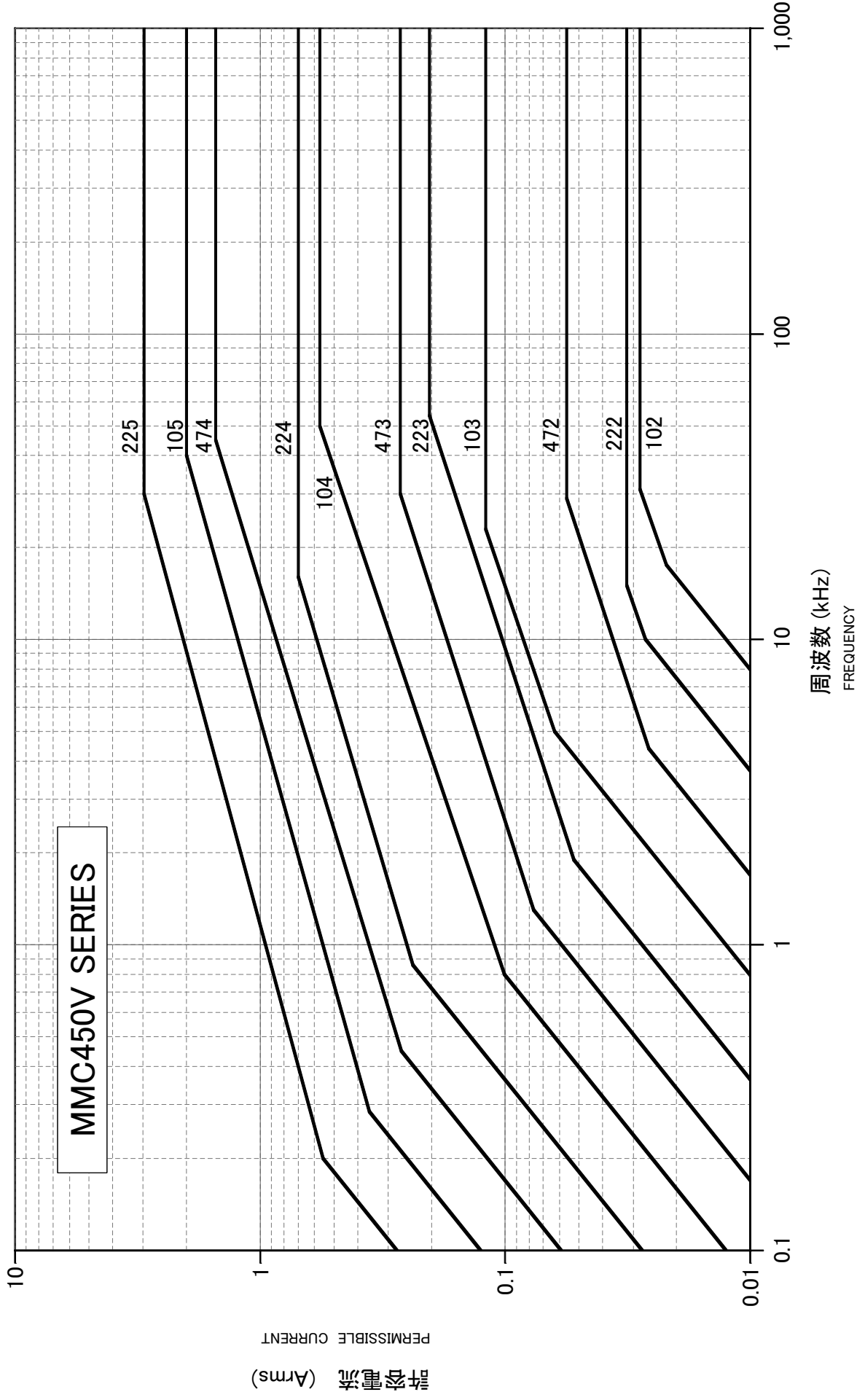

周波数に対する許容電流特性 (正弦波)

CHARACTERISTICS OF PERMISSIBLE CURRENT TO FREQUENCY (SINUSOIDAL WAVE)

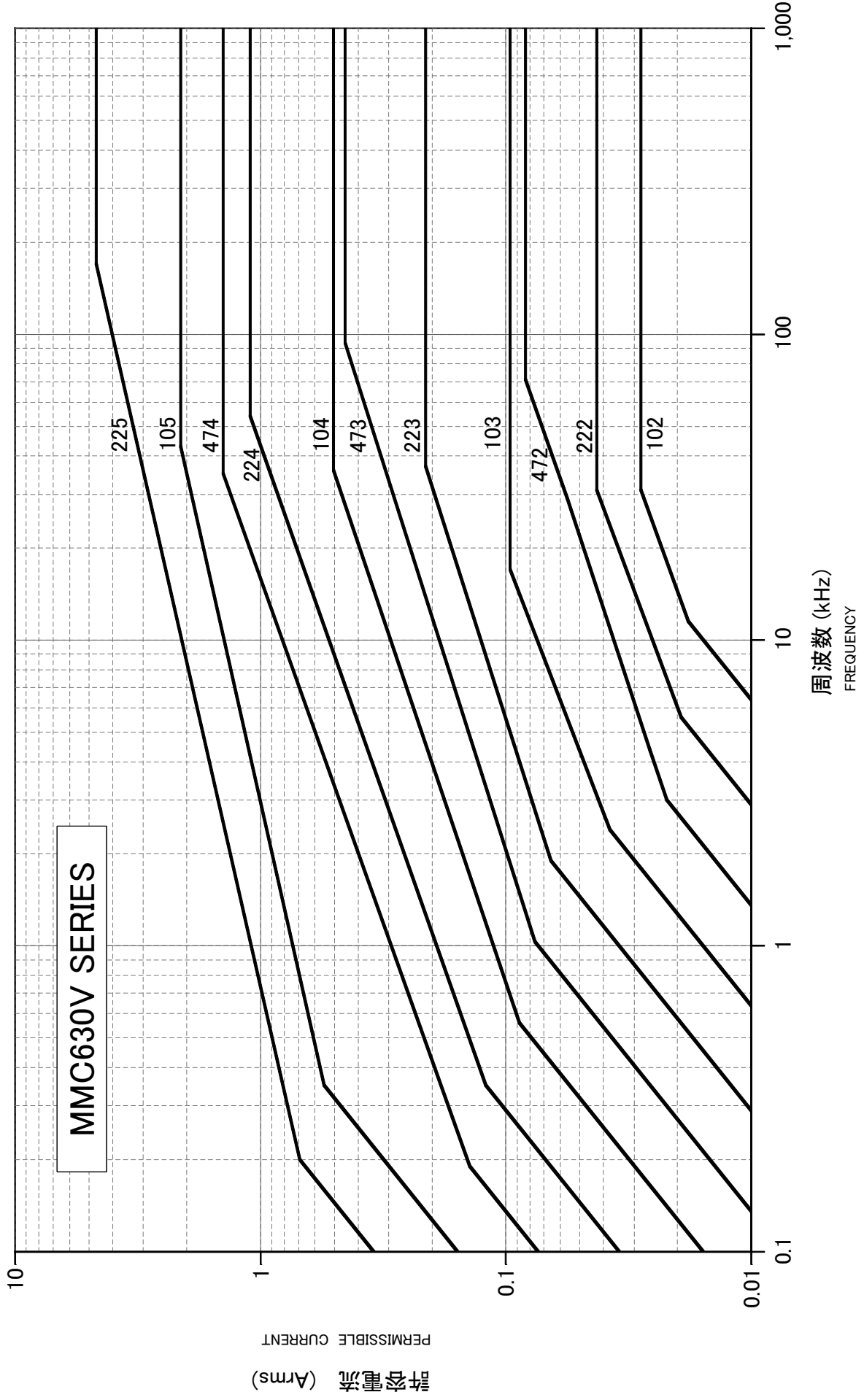

周波数に対する許容電流特性 (正弦波)

CHARACTERISTICS OF PERMISSIBLE CURRENT TO FREQUENCY (SINUSOIDAL WAVE)

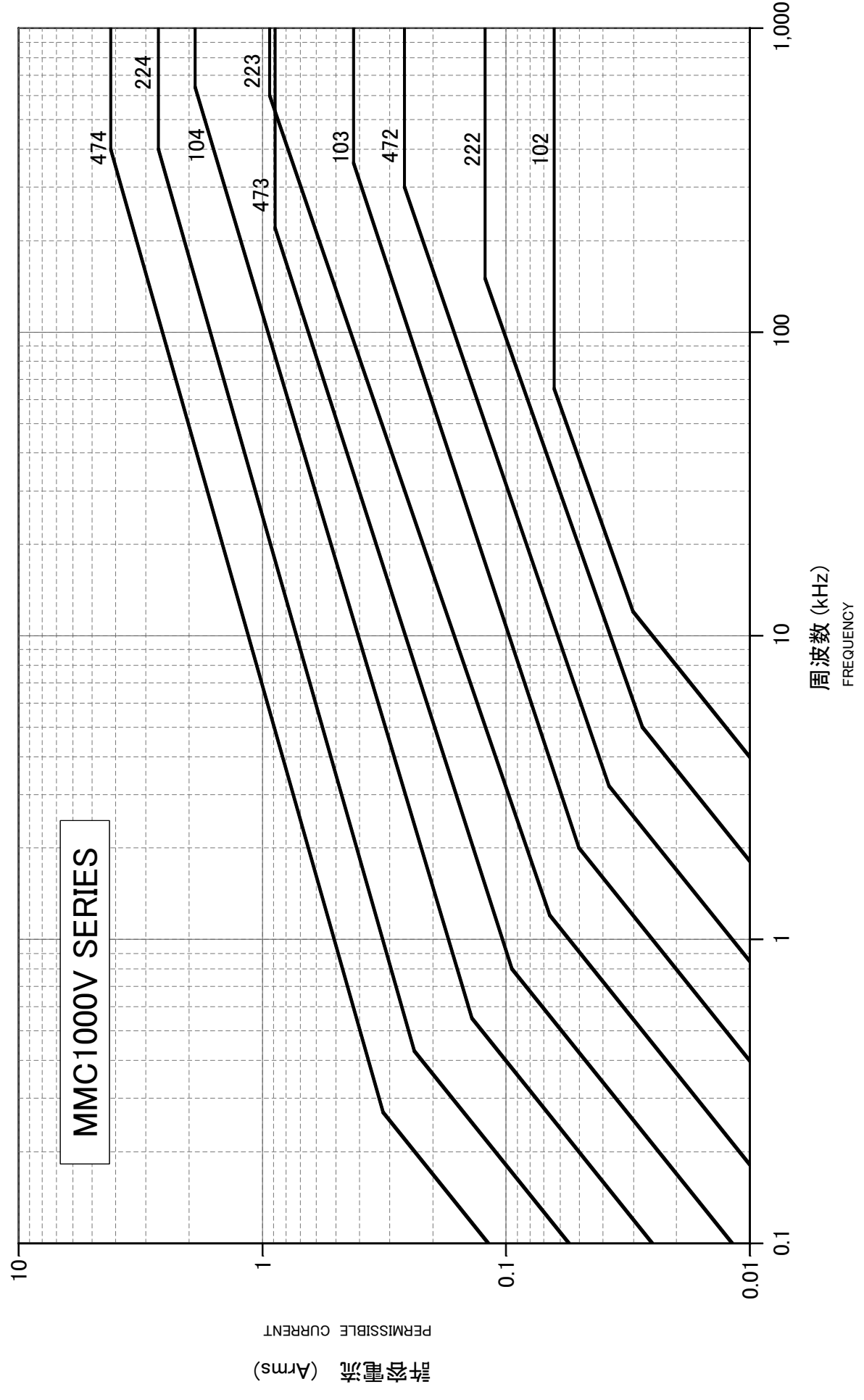

許容電流 (Arms)
PERMISSIBLE CURRENT

周波数 (kHz)
FREQUENCY

周波数に対する許容電流特性 (正弦波)

CHARACTERISTICS OF PERMISSIBLE CURRENT TO FREQUENCY (SINUSOIDAL WAVE)

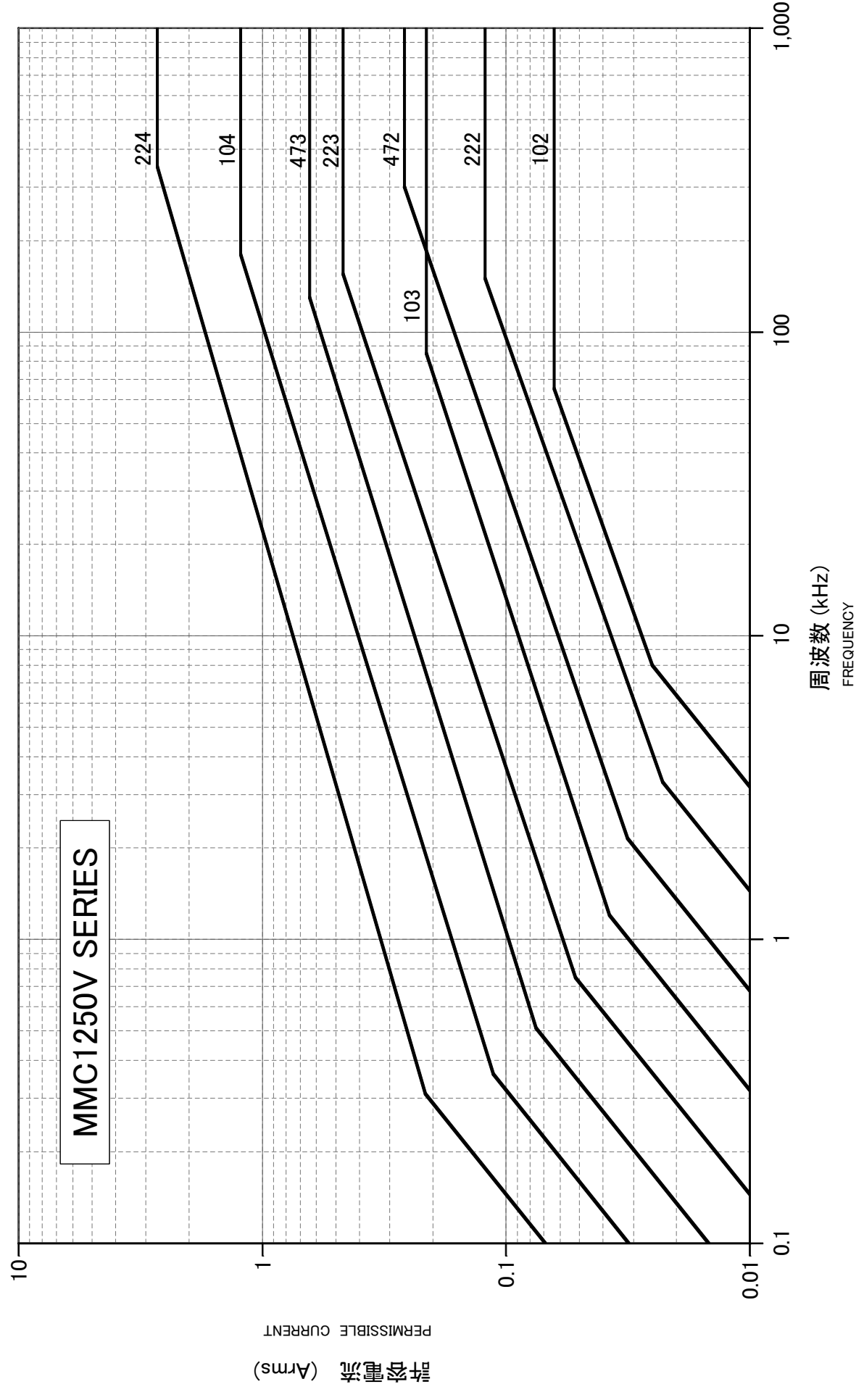

許容電流 (Arms)
PERMISSIBLE CURRENT

周波数 (kHz)
FREQUENCY

SPECIFICATION

METALLIZED POLYESTER FILM CAPACITOR

SPEC

PSC305000

Drawing of direction

• MMC : Straight lead type

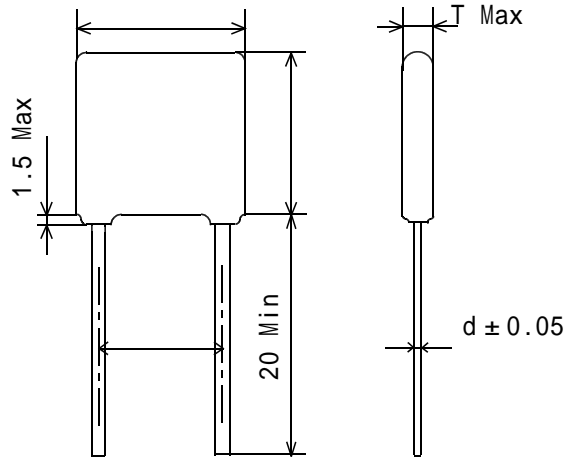

• MMCC : Cutted lead type

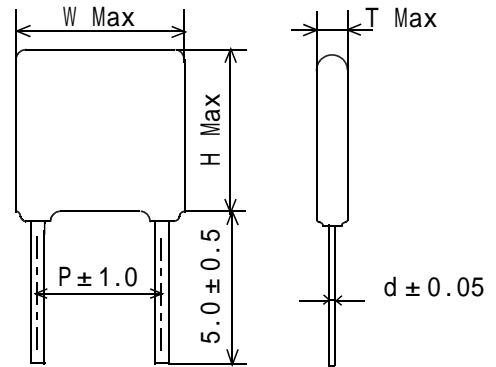

※ 2.0mmMax, when dimension of H are more than 20mm.

※※ 1000, 1250V.DC : $P \pm 1.5 \text{ mm}$

• MMC F : シングルフォーミング

《Type A》

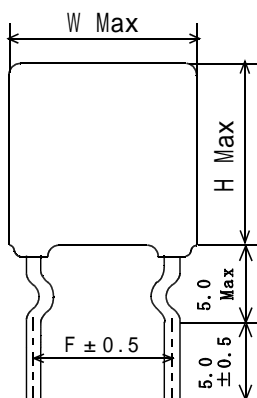

《Type B》

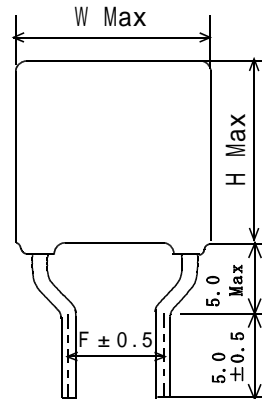
※※※ 1000, 1250V.DC : $F \pm 0.8 \text{ mm}$

| | | |
|---------------|-------------------------------------|---------------------------|
| SPECIFICATION | METALLIZED POLYESTER FILM CAPACITOR | SPEC P S C 3 0 5 0 0 0 |
|---------------|-------------------------------------|---------------------------|

MMC, MMCF, MMCC-100V.DC

| Parts | Capacitance (μ F) | Dimensions (mm) | | | | | | | | | | | |
|------------------|---------------------------|-----------------|------|-----|------|-----|---|-----|---|------|---|-----|---|
| | | W | H | T | P | F | | F | | F | d | | |
| MMC 0100 3330000 | 0.033 | 9.5 | 5.5 | 3.5 | 7.5 | 5.0 | A | 7.5 | A | | | 0.5 | ※ |
| MMC 0100 3930000 | 0.039 | 〃 | 〃 | 〃 | 〃 | 〃 | 〃 | 〃 | 〃 | | | 〃 | ※ |
| MMC 0100 4730000 | 0.047 | 〃 | 〃 | 〃 | 〃 | 〃 | 〃 | 〃 | 〃 | | | 〃 | ※ |
| MMC 0100 5630000 | 0.056 | 〃 | 〃 | 〃 | 〃 | 〃 | 〃 | 〃 | 〃 | | | 〃 | ※ |
| MMC 0100 6830000 | 0.068 | 〃 | 〃 | 〃 | 〃 | 〃 | 〃 | 〃 | 〃 | | | 〃 | ※ |
| MMC 0100 8230000 | 0.082 | 〃 | 〃 | 〃 | 〃 | 〃 | 〃 | 〃 | 〃 | | | 〃 | ※ |
| MMC 0100 1040000 | 0.10 | 10.0 | 7.0 | 3.8 | 〃 | 〃 | 〃 | 〃 | 〃 | | | 〃 | ※ |
| MMC 0100 1240000 | 0.12 | 〃 | 7.5 | 〃 | 〃 | 〃 | 〃 | 〃 | 〃 | | | 〃 | ※ |
| MMC 0100 1540000 | 0.15 | 〃 | 8.0 | 4.0 | 〃 | 〃 | 〃 | 〃 | 〃 | | | 〃 | ※ |
| MMC 0100 1840000 | 0.18 | 〃 | 〃 | 4.3 | 〃 | 〃 | 〃 | 〃 | 〃 | | | 〃 | ※ |
| MMC 0100 2240000 | 0.22 | 〃 | 〃 | 4.5 | 〃 | 〃 | 〃 | 〃 | 〃 | | | 〃 | ※ |
| MMC 0100 2740000 | 0.27 | 〃 | 9.8 | 〃 | 〃 | 〃 | 〃 | 〃 | 〃 | | | 〃 | ※ |
| MMC 0100 3340000 | 0.33 | 〃 | 11.0 | 〃 | 〃 | 〃 | 〃 | 〃 | 〃 | | | 〃 | ※ |
| MMC 0100 3940000 | 0.39 | 〃 | 11.5 | 5.0 | 〃 | 〃 | 〃 | 〃 | 〃 | | | 〃 | ※ |
| MMC 0100 4740000 | 0.47 | 〃 | 12.0 | 5.3 | 〃 | 〃 | 〃 | 〃 | 〃 | | | 〃 | ※ |
| MMC 0100 5640000 | 0.56 | 12.5 | 10.5 | 〃 | 10.0 | 〃 | B | 〃 | 〃 | 10.0 | A | 0.6 | ※ |
| MMC 0100 6840000 | 0.68 | 〃 | 〃 | 6.4 | 〃 | 〃 | 〃 | 〃 | 〃 | 〃 | 〃 | 〃 | ※ |
| MMC 0100 8240000 | 0.82 | 〃 | 13.5 | 5.7 | 〃 | 〃 | 〃 | 〃 | 〃 | 〃 | 〃 | 〃 | ※ |
| MMC 0100 1050000 | 1.0 | 〃 | 14.0 | 6.0 | 〃 | 〃 | 〃 | 〃 | 〃 | 〃 | 〃 | 〃 | ※ |
| MMC 0100 1250000 | 1.2 | 18.0 | 12.0 | 5.5 | 15.0 | 〃 | 〃 | 〃 | B | 15.0 | 〃 | 0.8 | ※ |
| MMC 0100 1550000 | 1.5 | 〃 | 13.0 | 6.0 | 〃 | 〃 | 〃 | 〃 | 〃 | 〃 | 〃 | 〃 | ※ |
| MMC 0100 1850000 | 1.8 | 〃 | 13.5 | 6.5 | 〃 | 〃 | 〃 | 〃 | 〃 | 〃 | 〃 | 〃 | ※ |
| MMC 0100 2250000 | 2.2 | 〃 | 14.0 | 7.3 | 〃 | 〃 | 〃 | 〃 | 〃 | 〃 | 〃 | 〃 | ※ |
| MMC 0100 2750000 | 2.7 | 25.0 | 13.5 | 6.5 | 22.5 | | | | | 22.5 | 〃 | 〃 | ※ |
| MMC 0100 3350000 | 3.3 | 〃 | 15.0 | 7.0 | 〃 | | | | | 〃 | 〃 | 〃 | ※ |
| MMC 0100 3950000 | 3.9 | 〃 | 16.0 | 7.5 | 〃 | | | | | 〃 | 〃 | 〃 | ※ |
| MMC 0100 4750000 | 4.7 | 〃 | 17.0 | 8.0 | 〃 | | | | | 〃 | 〃 | 〃 | ※ |

Tinned copper-covered steel wire

| SPECIFICATION | METALLIZED POLYESTER FILM CAPACITOR | SPEC | | | | | | | | | | |
|-------------------------|-------------------------------------|-------------------|------|-----|------|-----|---|-----|---|------|---|-----|
| | | P S C 3 0 5 0 0 0 | | | | | | | | | | |
| MMC, MMCF, MMCC-250V.DC | | | | | | | | | | | | |
| Parts No. | Capacitance (μ F) | Dimensions (mm) | | | | | | | | | | |
| | | W | H | T | P | F | | F | | F | | d |
| MMC 0250 1020000 | 0.0010 | 10.3 | 7.0 | 4.0 | 7.5 | 5.0 | A | 7.5 | A | | | 0.6 |
| MMC 0250 1220000 | 0.0012 | 〃 | 〃 | 〃 | 〃 | 〃 | 〃 | 〃 | 〃 | | | 〃 |
| MMC 0250 1520000 | 0.0015 | 〃 | 〃 | 〃 | 〃 | 〃 | 〃 | 〃 | 〃 | | | 〃 |
| MMC 0250 1820000 | 0.0018 | 〃 | 〃 | 〃 | 〃 | 〃 | 〃 | 〃 | 〃 | | | 〃 |
| MMC 0250 2220000 | 0.0022 | 〃 | 〃 | 〃 | 〃 | 〃 | 〃 | 〃 | 〃 | | | 〃 |
| MMC 0250 2720000 | 0.0027 | 〃 | 〃 | 〃 | 〃 | 〃 | 〃 | 〃 | 〃 | | | 〃 |
| MMC 0250 3320000 | 0.0033 | 〃 | 〃 | 〃 | 〃 | 〃 | 〃 | 〃 | 〃 | | | 〃 |
| MMC 0250 3920000 | 0.0039 | 〃 | 〃 | 〃 | 〃 | 〃 | 〃 | 〃 | 〃 | | | 〃 |
| MMC 0250 4720000 | 0.0047 | 〃 | 〃 | 〃 | 〃 | 〃 | 〃 | 〃 | 〃 | | | 〃 |
| MMC 0250 5620000 | 0.0056 | 〃 | 〃 | 〃 | 〃 | 〃 | 〃 | 〃 | 〃 | | | 〃 |
| MMC 0250 6820000 | 0.0068 | 〃 | 〃 | 〃 | 〃 | 〃 | 〃 | 〃 | 〃 | | | 〃 |
| MMC 0250 8220000 | 0.0082 | 〃 | 〃 | 〃 | 〃 | 〃 | 〃 | 〃 | 〃 | | | 〃 |
| MMC 0250 1030000 | 0.010 | 〃 | 7.4 | 4.3 | 〃 | 〃 | 〃 | 〃 | 〃 | | | 〃 |
| MMC 0250 1230000 | 0.012 | 〃 | 〃 | 4.4 | 〃 | 〃 | 〃 | 〃 | 〃 | | | 〃 |
| MMC 0250 1530000 | 0.015 | 〃 | 7.5 | 〃 | 〃 | 〃 | 〃 | 〃 | 〃 | | | 〃 |
| MMC 0250 1830000 | 0.018 | 〃 | 〃 | 〃 | 〃 | 〃 | 〃 | 〃 | 〃 | | | 〃 |
| MMC 0250 2230000 | 0.022 | 〃 | 〃 | 〃 | 〃 | 〃 | 〃 | 〃 | 〃 | | | 〃 |
| MMC 0250 2730000 | 0.027 | 〃 | 〃 | 〃 | 〃 | 〃 | 〃 | 〃 | 〃 | | | 〃 |
| MMC 0250 3330000 | 0.033 | 〃 | 〃 | 〃 | 〃 | 〃 | 〃 | 〃 | 〃 | | | 〃 |
| MMC 0250 3930000 | 0.039 | 〃 | 〃 | 4.5 | 〃 | 〃 | 〃 | 〃 | 〃 | | | 〃 |
| MMC 0250 4730000 | 0.047 | 〃 | 7.9 | 4.4 | 〃 | 〃 | 〃 | 〃 | 〃 | | | 〃 |
| MMC 0250 5630000 | 0.056 | 〃 | 〃 | 4.8 | 〃 | 〃 | 〃 | 〃 | 〃 | | | 〃 |
| MMC 0250 6830000 | 0.068 | 〃 | 7.5 | 4.5 | 〃 | 〃 | 〃 | 〃 | 〃 | | | 〃 |
| MMC 0250 8230000 | 0.082 | 〃 | 8.0 | 4.8 | 〃 | 〃 | 〃 | 〃 | 〃 | | | 〃 |
| MMC 0250 1040000 | 0.10 | 〃 | 8.4 | 5.8 | 〃 | 〃 | 〃 | 〃 | 〃 | | | 〃 |
| MMC 0250 1240000 | 0.12 | 〃 | 9.0 | 6.0 | 〃 | 〃 | 〃 | 〃 | 〃 | | | 〃 |
| MMC 0250 1540000 | 0.15 | 〃 | 10.8 | 〃 | 〃 | 〃 | 〃 | 〃 | 〃 | | | 〃 |
| MMC 0250 1840000 | 0.18 | 12.5 | 10.0 | 5.0 | 10.0 | 〃 | B | 〃 | 〃 | 10.0 | A | 〃 |
| MMC 0250 2240000 | 0.22 | 〃 | 10.3 | 5.5 | 〃 | 〃 | 〃 | 〃 | 〃 | 〃 | 〃 | 〃 |
| MMC 0250 2740000 | 0.27 | 〃 | 11.0 | 6.0 | 〃 | 〃 | 〃 | 〃 | 〃 | 〃 | 〃 | 〃 |
| MMC 0250 3340000 | 0.33 | 〃 | 11.5 | 6.5 | 〃 | 〃 | 〃 | 〃 | 〃 | 〃 | 〃 | 〃 |
| MMC 0250 3940000 | 0.39 | 18.0 | 12.0 | 4.9 | 15.0 | 〃 | 〃 | 〃 | B | 15.0 | 〃 | 〃 |
| MMC 0250 4740000 | 0.47 | 〃 | 12.5 | 5.3 | 〃 | 〃 | 〃 | 〃 | 〃 | 〃 | 〃 | 〃 |
| MMC 0250 5640000 | 0.56 | 〃 | 13.0 | 5.5 | 〃 | 〃 | 〃 | 〃 | 〃 | 〃 | 〃 | 〃 |
| MMC 0250 6840000 | 0.68 | 〃 | 13.5 | 6.0 | 〃 | 〃 | 〃 | 〃 | 〃 | 〃 | 〃 | 〃 |
| MMC 0250 8240000 | 0.82 | 〃 | 14.5 | 6.5 | 〃 | 〃 | 〃 | 〃 | 〃 | 〃 | 〃 | 〃 |
| MMC 0250 9040000 | 0.90 | 〃 | 〃 | 7.0 | 〃 | 〃 | 〃 | 〃 | 〃 | 〃 | 〃 | 〃 |

| | | |
|---------------|-------------------------------------|---------------------------|
| SPECIFICATION | METALLIZED POLYESTER FILM CAPACITOR | SPEC P S C 3 0 5 0 0 0 |
|---------------|-------------------------------------|---------------------------|

MMC, MMCF, MMCC-250V.DC

| Parts No. | Capacitance (μ F) | Dimensions (mm) | | | | | | | | | | |
|------------------|---------------------------|-----------------|------|------|------|-----|---|-----|---|------|---|-----|
| | | W | H | T | P | F | | F | | F | d | |
| MMC 0250 1050000 | 1.0 | 18.0 | 15.0 | 7.4 | 15.0 | 5.0 | B | 7.5 | B | 15.0 | A | 0.8 |
| MMC 0250 1250000 | 1.2 | " | 15.9 | 8.0 | " | " | " | " | " | " | " | " |
| MMC 0250 1550000 | 1.5 | " | 16.8 | 9.0 | " | " | " | " | " | " | " | " |
| MMC 0250 1850000 | 1.8 | 25.0 | 15.5 | 7.5 | 22.5 | " | " | " | " | 22.5 | " | " |
| MMC 0250 2250000 | 2.2 | " | 16.3 | 8.5 | " | " | " | " | " | " | " | " |
| MMC 0250 2750000 | 2.7 | " | 17.1 | 9.4 | " | " | " | " | " | " | " | " |
| MMC 0250 3350000 | 3.3 | " | 18.0 | 10.3 | " | " | " | " | " | " | " | " |
| MMC 0250 3950000 | 3.9 | " | 20.5 | 11.0 | " | " | " | " | " | " | " | " |
| MMC 0250 4750000 | 4.7 | " | 21.5 | 12.0 | " | " | " | " | " | " | " | " |
| MMC 0250 5650000 | 5.6 | 30.0 | 21.0 | 11.8 | 27.5 | " | " | " | " | 27.5 | " | " |
| MMC 0250 6850000 | 6.8 | " | 22.4 | 13.0 | " | " | " | " | " | " | " | " |
| MMC 0250 8250000 | 8.2 | " | 23.5 | 14.3 | " | " | " | " | " | " | " | " |
| MMC 0250 1060000 | 10.0 | " | 25.8 | 15.9 | " | " | " | " | " | " | " | " |

| | | | |
|---------------|-------------------------------------|-------------------|--|
| SPECIFICATION | METALLIZED POLYESTER FILM CAPACITOR | SPEC | |
| | | P S C 3 0 5 0 0 0 | |

MMC, MMCF, MMCC-400V.DC

| Parts No. | Capacitance (μ F) | Dimensions (mm) | | | | | | | | | | |
|------------------|---------------------------|-----------------|------|-----|------|-----|----|-----|----|------|----|-----|
| | | W | H | T | P | F | | F | | F | d | |
| MMC 0400 1020000 | 0.0010 | 10.3 | 7.0 | 4.0 | 7.5 | 5.0 | A | 7.5 | A | | | 0.6 |
| MMC 0400 1220000 | 0.0012 | '' | '' | '' | '' | '' | '' | '' | '' | | | '' |
| MMC 0400 1520000 | 0.0015 | '' | '' | '' | '' | '' | '' | '' | '' | | | '' |
| MMC 0400 1820000 | 0.0018 | '' | '' | '' | '' | '' | '' | '' | '' | | | '' |
| MMC 0400 2220000 | 0.0022 | '' | '' | '' | '' | '' | '' | '' | '' | | | '' |
| MMC 0400 2720000 | 0.0027 | '' | '' | '' | '' | '' | '' | '' | '' | | | '' |
| MMC 0400 3320000 | 0.0033 | '' | '' | '' | '' | '' | '' | '' | '' | | | '' |
| MMC 0400 3920000 | 0.0039 | '' | '' | '' | '' | '' | '' | '' | '' | | | '' |
| MMC 0400 4720000 | 0.0047 | '' | '' | '' | '' | '' | '' | '' | '' | | | '' |
| MMC 0400 5620000 | 0.0056 | '' | '' | '' | '' | '' | '' | '' | '' | | | '' |
| MMC 0400 6820000 | 0.0068 | '' | '' | '' | '' | '' | '' | '' | '' | | | '' |
| MMC 0400 8220000 | 0.0082 | '' | '' | '' | '' | '' | '' | '' | '' | | | '' |
| MMC 0400 1030000 | 0.010 | '' | 7.6 | 4.4 | '' | '' | '' | '' | '' | | | '' |
| MMC 0400 1230000 | 0.012 | '' | 7.8 | '' | '' | '' | '' | '' | '' | | | '' |
| MMC 0400 1530000 | 0.015 | '' | '' | '' | '' | '' | '' | '' | '' | | | '' |
| MMC 0400 1830000 | 0.018 | '' | 7.6 | '' | '' | '' | '' | '' | '' | | | '' |
| MMC 0400 2230000 | 0.022 | '' | 7.9 | 4.5 | '' | '' | '' | '' | '' | | | '' |
| MMC 0400 2730000 | 0.027 | '' | 8.2 | 4.8 | '' | '' | '' | '' | '' | | | '' |
| MMC 0400 3330000 | 0.033 | '' | 9.0 | 5.5 | '' | '' | '' | '' | '' | | | '' |
| MMC 0400 3930000 | 0.039 | 12.5 | 8.0 | 4.9 | 10.0 | '' | B | '' | '' | 10.0 | A | '' |
| MMC 0400 4730000 | 0.047 | '' | 8.3 | 5.2 | '' | '' | '' | '' | '' | '' | '' | '' |
| MMC 0400 5630000 | 0.056 | '' | 10.0 | '' | '' | '' | '' | '' | '' | '' | '' | '' |
| MMC 0400 6830000 | 0.068 | '' | 10.5 | 5.5 | '' | '' | '' | '' | '' | '' | '' | '' |
| MMC 0400 8230000 | 0.082 | '' | 11.0 | 6.0 | '' | '' | '' | '' | '' | '' | '' | '' |
| MMC 0400 1040000 | 0.10 | '' | 12.0 | '' | '' | '' | '' | '' | '' | '' | '' | '' |
| MMC 0400 1240000 | 0.12 | 18.0 | 10.2 | 5.5 | 15.0 | '' | '' | '' | B | 15.0 | '' | '' |
| MMC 0400 1540000 | 0.15 | '' | 12.0 | '' | '' | '' | '' | '' | '' | '' | '' | '' |
| MMC 0400 1840000 | 0.18 | '' | 12.5 | 6.0 | '' | '' | '' | '' | '' | '' | '' | '' |
| MMC 0400 2240000 | 0.22 | '' | 13.0 | 6.5 | '' | '' | '' | '' | '' | '' | '' | '' |
| MMC 0400 2740000 | 0.27 | '' | 13.5 | 7.0 | '' | '' | '' | '' | '' | '' | '' | 0.8 |
| MMC 0400 3340000 | 0.33 | '' | 14.0 | 7.7 | '' | '' | '' | '' | '' | '' | '' | '' |
| MMC 0400 3940000 | 0.39 | '' | 15.0 | 8.5 | '' | '' | '' | '' | '' | '' | '' | '' |
| MMC 0400 4740000 | 0.47 | '' | 16.5 | '' | '' | '' | '' | '' | '' | '' | '' | '' |
| MMC 0400 5640000 | 0.56 | 25.0 | 15.3 | 7.5 | 22.5 | | | | | 22.5 | '' | '' |
| MMC 0400 6840000 | 0.68 | '' | 16.0 | 8.2 | '' | | | | | '' | '' | '' |
| MMC 0400 8240000 | 0.82 | '' | 16.8 | 9.0 | '' | | | | | '' | '' | '' |

| | | |
|---------------|-------------------------------------|---------------------------|
| SPECIFICATION | METALLIZED POLYESTER FILM CAPACITOR | SPEC P S C 3 0 5 0 0 0 |
|---------------|-------------------------------------|---------------------------|

MMC, MMCF, MMCC-400V.DC

| Parts No. | Capacitance (μ F) | Dimensions (mm) | | | | | | | | | |
|------------------|---------------------------|-----------------|------|------|------|---|---|---|------|---|-----|
| | | W | H | T | P | F | F | F | F | d | |
| MMC 0400 1050000 | 1.0 | 25.0 | 17.7 | 10.0 | 22.5 | | | | 22.5 | A | 0.8 |
| MMC 0400 1250000 | 1.2 | " | 18.8 | 11.0 | " | | | | " | " | " |
| MMC 0400 1550000 | 1.5 | 30.0 | 19.5 | 10.0 | 27.5 | | | | 27.5 | " | " |
| MMC 0400 1850000 | 1.8 | " | 18.7 | 9.3 | " | | | | " | " | " |
| MMC 0400 2250000 | 2.2 | " | 19.8 | 10.4 | " | | | | " | " | " |
| MMC 0400 2750000 | 2.7 | " | 21.0 | 11.6 | " | | | | " | " | " |
| MMC 0400 3350000 | 3.3 | " | 22.3 | 13.0 | " | | | | " | " | " |
| MMC 0400 3950000 | 3.9 | " | 23.6 | 14.2 | " | | | | " | " | " |
| MMC 0400 4750000 | 4.7 | " | 25.2 | 15.8 | " | | | | " | " | " |

| | | |
|---------------|-------------------------------------|-------------------|
| SPECIFICATION | METALLIZED POLYESTER FILM CAPACITOR | SPEC |
| | | P S C 3 0 5 0 0 0 |

MMC, MMCF, MMCC-450V.DC

| Parts No. | Capacitance (μ F) | Dimensions (mm) | | | | | | | | | | |
|------------------|---------------------------|-----------------|------|-----|------|-----|----|-----|----|------|-----|-----|
| | | W | H | T | P | F | | F | | F | d | |
| MMC 0450 1020000 | 0.0010 | 10.3 | 7.0 | 4.0 | 7.5 | 5.0 | A | 7.5 | A | | 0.6 | |
| MMC 0450 1220000 | 0.0012 | '' | '' | '' | '' | '' | '' | '' | '' | | '' | |
| MMC 0450 1520000 | 0.0015 | '' | '' | '' | '' | '' | '' | '' | '' | | '' | |
| MMC 0450 1820000 | 0.0018 | '' | '' | '' | '' | '' | '' | '' | '' | | '' | |
| MMC 0450 2220000 | 0.0022 | '' | '' | '' | '' | '' | '' | '' | '' | | '' | |
| MMC 0450 2720000 | 0.0027 | '' | '' | '' | '' | '' | '' | '' | '' | | '' | |
| MMC 0450 3320000 | 0.0033 | '' | '' | '' | '' | '' | '' | '' | '' | | '' | |
| MMC 0450 3920000 | 0.0039 | '' | '' | '' | '' | '' | '' | '' | '' | | '' | |
| MMC 0450 4720000 | 0.0047 | '' | '' | '' | '' | '' | '' | '' | '' | | '' | |
| MMC 0450 5620000 | 0.0056 | '' | '' | '' | '' | '' | '' | '' | '' | | '' | |
| MMC 0450 6820000 | 0.0068 | '' | '' | '' | '' | '' | '' | '' | '' | | '' | |
| MMC 0450 8220000 | 0.0082 | '' | '' | '' | '' | '' | '' | '' | '' | | '' | |
| MMC 0450 1030000 | 0.010 | '' | 7.6 | 4.4 | '' | '' | '' | '' | '' | | '' | |
| MMC 0450 1230000 | 0.012 | '' | 7.8 | '' | '' | '' | '' | '' | '' | | '' | |
| MMC 0450 1530000 | 0.015 | '' | '' | '' | '' | '' | '' | '' | '' | | '' | |
| MMC 0450 1830000 | 0.018 | '' | 7.6 | '' | '' | '' | '' | '' | '' | | '' | |
| MMC 0450 2230000 | 0.022 | '' | 7.9 | 4.5 | '' | '' | '' | '' | '' | | '' | |
| MMC 0450 2730000 | 0.027 | '' | 8.2 | 4.8 | '' | '' | '' | '' | '' | | '' | |
| MMC 0450 3330000 | 0.033 | '' | 9.0 | 5.5 | '' | '' | '' | '' | '' | | '' | |
| MMC 0450 3930000 | 0.039 | 12.5 | 8.0 | 4.9 | 10.0 | '' | B | '' | '' | 10.0 | A | '' |
| MMC 0450 4730000 | 0.047 | '' | 8.3 | 5.2 | '' | '' | '' | '' | '' | '' | '' | '' |
| MMC 0450 5630000 | 0.056 | '' | 10.0 | '' | '' | '' | '' | '' | '' | '' | '' | '' |
| MMC 0450 6830000 | 0.068 | '' | 10.5 | 5.5 | '' | '' | '' | '' | '' | '' | '' | '' |
| MMC 0450 8230000 | 0.082 | '' | 11.0 | 6.0 | '' | '' | '' | '' | '' | '' | '' | '' |
| MMC 0450 1040000 | 0.10 | '' | 12.0 | '' | '' | '' | '' | '' | '' | '' | '' | '' |
| MMC 0450 1240000 | 0.12 | 18.0 | 10.2 | 5.5 | 15.0 | '' | '' | '' | B | '' | '' | '' |
| MMC 0450 1540000 | 0.15 | '' | 12.0 | '' | '' | '' | '' | '' | '' | '' | '' | '' |
| MMC 0450 1840000 | 0.18 | '' | 12.5 | 6.0 | '' | '' | '' | '' | '' | 15.0 | '' | '' |
| MMC 0450 2240000 | 0.22 | '' | 13.0 | 6.5 | '' | '' | '' | '' | '' | '' | '' | '' |
| MMC 0450 2740000 | 0.27 | '' | 13.5 | 7.0 | '' | '' | '' | '' | '' | '' | '' | 0.8 |
| MMC 0450 3340000 | 0.33 | '' | 14.0 | 7.7 | '' | '' | '' | '' | '' | '' | '' | '' |
| MMC 0450 3940000 | 0.39 | '' | 15.0 | 8.5 | '' | '' | '' | '' | '' | '' | '' | '' |
| MMC 0450 4740000 | 0.47 | '' | 16.5 | '' | '' | '' | '' | '' | '' | '' | '' | '' |
| MMC 0450 5640000 | 0.56 | 25.0 | 15.3 | 7.5 | 22.5 | | | | | 22.5 | '' | '' |
| MMC 0450 6840000 | 0.68 | '' | 16.0 | 8.2 | '' | | | | | '' | '' | '' |
| MMC 0450 8240000 | 0.82 | '' | 16.8 | 9.0 | '' | | | | | '' | '' | '' |

| | | |
|---------------|-------------------------------------|---------------------------|
| SPECIFICATION | METALLIZED POLYESTER FILM CAPACITOR | SPEC P S C 3 0 5 0 0 0 |
|---------------|-------------------------------------|---------------------------|

MMC, MMCF, MMCC-450V.DC

| Parts No. | Capacitance (μ F) | Dimensions (mm) | | | | | | | | | |
|------------------|---------------------------|-----------------|------|------|------|---|---|---|------|---|-----|
| | | W | H | T | P | F | F | F | F | d | |
| MMC 0450 1050000 | 1.0 | 25.0 | 17.7 | 10.0 | 22.5 | | | | 22.5 | A | 0.8 |
| MMC 0450 1250000 | 1.2 | " | 18.8 | 11.0 | " | | | | " | " | " |
| MMC 0450 1550000 | 1.5 | 30.0 | 19.5 | 10.0 | 27.5 | | | | 27.5 | " | " |
| MMC 0450 1850000 | 1.8 | " | 21.5 | 11.0 | " | | | | " | " | " |
| MMC 0450 2250000 | 2.2 | " | 23.0 | 12.5 | " | | | | " | " | " |
| MMC 0450 2750000 | 2.7 | " | 25.0 | 14.0 | " | | | | " | " | " |
| MMC 0450 3350000 | 3.3 | " | 26.5 | 15.5 | " | | | | " | " | " |

| SPECIFICATION | METALLIZED POLYESTER FILM CAPACITOR | SPEC | | | | | | | | | |
|-------------------------|-------------------------------------|-------------------|------|------|------|-----|---|-----|---|------|-----|
| | | P S C 3 0 5 0 0 0 | | | | | | | | | |
| MMC, MMCF, MMCC-630V.DC | | | | | | | | | | | |
| Parts No. | Capacitance (μ F) | Dimensions (mm) | | | | | | | | | |
| | | W | H | T | P | F | | F | | F | d |
| MMC 0630 1020000 | 0.0010 | 10.3 | 7.5 | 4.5 | 7.5 | 5.0 | A | 7.5 | A | | 0.6 |
| MMC 0630 1220000 | 0.0012 | " | " | " | " | " | " | " | " | " | " |
| MMC 0630 1520000 | 0.0015 | " | " | " | " | " | " | " | " | " | " |
| MMC 0630 1820000 | 0.0018 | " | " | " | " | " | " | " | " | " | " |
| MMC 0630 2220000 | 0.0022 | " | " | " | " | " | " | " | " | " | " |
| MMC 0630 2720000 | 0.0027 | " | " | " | " | " | " | " | " | " | " |
| MMC 0630 3320000 | 0.0033 | " | " | " | " | " | " | " | " | " | " |
| MMC 0630 3920000 | 0.0039 | " | " | " | " | " | " | " | " | " | " |
| MMC 0630 4720000 | 0.0047 | " | " | " | " | " | " | " | " | " | " |
| MMC 0630 5620000 | 0.0056 | " | " | " | " | " | " | " | " | " | " |
| MMC 0630 6820000 | 0.0068 | " | " | " | " | " | " | " | " | " | " |
| MMC 0630 8220000 | 0.0082 | " | " | " | " | " | " | " | " | " | " |
| MMC 0630 1030000 | 0.010 | 12.5 | " | 4.0 | 10.0 | " | B | " | " | 10.0 | A |
| MMC 0630 1230000 | 0.012 | " | " | 4.5 | " | " | " | " | " | " | " |
| MMC 0630 1530000 | 0.015 | " | 8.2 | 5.0 | " | " | " | " | " | " | " |
| MMC 0630 1830000 | 0.018 | " | 10.0 | " | " | " | " | " | " | " | " |
| MMC 0630 2230000 | 0.022 | " | 10.5 | 5.3 | " | " | " | " | " | " | " |
| MMC 0630 2730000 | 0.027 | " | " | 5.5 | " | " | " | " | " | " | " |
| MMC 0630 3330000 | 0.033 | " | 11.0 | 6.0 | " | " | " | " | " | " | " |
| MMC 0630 3930000 | 0.039 | " | 12.5 | " | " | " | " | " | " | " | " |
| MMC 0630 4730000 | 0.047 | " | 13.0 | 6.5 | " | " | " | " | " | " | " |
| MMC 0630 5630000 | 0.056 | 18.0 | 10.5 | 5.5 | 15.0 | " | " | " | B | 15.0 | " |
| MMC 0630 6830000 | 0.068 | " | 11.0 | 6.0 | " | " | " | " | " | " | " |
| MMC 0630 8230000 | 0.082 | " | 11.5 | 6.5 | " | " | " | " | " | " | " |
| MMC 0630 1040000 | 0.10 | " | 13.0 | " | " | " | " | " | " | " | " |
| MMC 0630 1240000 | 0.12 | " | 13.5 | 7.0 | " | " | " | " | " | " | 0.8 |
| MMC 0630 1540000 | 0.15 | " | 14.5 | 8.0 | " | " | " | " | " | " | " |
| MMC 0630 1840000 | 0.18 | " | 16.0 | " | " | " | " | " | " | " | " |
| MMC 0630 2240000 | 0.22 | " | 16.5 | 9.0 | " | " | " | " | " | " | " |
| MMC 0630 2740000 | 0.27 | 25.0 | 16.8 | 7.5 | 22.5 | | | | | 22.5 | " |
| MMC 0630 3340000 | 0.33 | " | 17.5 | 8.0 | " | | | | | " | " |
| MMC 0630 3940000 | 0.39 | " | 18.0 | 8.7 | " | | | | | " | " |
| MMC 0630 4740000 | 0.47 | " | 19.0 | 9.5 | " | | | | | " | " |
| MMC 0630 5640000 | 0.56 | " | 20.0 | 10.5 | " | | | | | " | " |
| MMC 0630 6840000 | 0.68 | " | 21.5 | 11.5 | " | | | | | " | " |
| MMC 0630 8240000 | 0.82 | 30.0 | 20.0 | 10.5 | 27.5 | | | | | 27.5 | " |

| | | |
|---------------|-------------------------------------|---------------------------|
| SPECIFICATION | METALLIZED POLYESTER FILM CAPACITOR | SPEC P S C 3 0 5 0 0 0 |
|---------------|-------------------------------------|---------------------------|

MMC, MMCF, MMCC-630V.DC

| Parts No. | Capacitance (μ F) | Dimensions (mm) | | | | | | | | | |
|------------------|---------------------------|-----------------|------|------|------|---|---|---|------|---|-----|
| | | W | H | T | P | F | F | F | F | d | |
| MMC 0630 1050000 | 1.0 | 30.0 | 21.0 | 11.5 | 27.5 | | | | 27.5 | A | 0.8 |
| MMC 0630 1250000 | 1.2 | " | 22.0 | 12.5 | " | | | | " | " | " |
| MMC 0630 1550000 | 1.5 | " | 24.0 | 14.3 | " | | | | " | " | " |
| MMC 0630 1850000 | 1.8 | " | 25.5 | 15.5 | " | | | | " | " | " |
| MMC 0630 2250000 | 2.2 | " | 27.3 | 17.5 | " | | | | " | " | " |

SPECIFICATION

METALLIZED POLYESTER FILM CAPACITOR

SPEC

P S C 3 0 5 0 0 0

MMC, MMCF, MMCC - 1000V . DC

| Parts No. | Capacitance (μ F) | Dimensions (mm) | | | | | | |
|------------------|---------------------------|-----------------|------|------|------|------|---|-----|
| | | W | H | T | P | F | d | |
| MMC 1000 1020000 | 0.0010 | 15.5 | 11.0 | 6.0 | 12.5 | 10.0 | A | 0.6 |
| MMC 1000 1220000 | 0.0012 | " | " | " | " | " | " | " |
| MMC 1000 1520000 | 0.0015 | " | " | " | " | " | " | " |
| MMC 1000 1820000 | 0.0018 | " | " | " | " | " | " | " |
| MMC 1000 2220000 | 0.0022 | " | 11.5 | " | " | " | " | " |
| MMC 1000 2720000 | 0.0027 | " | 12.0 | 6.5 | " | " | " | " |
| MMC 1000 3320000 | 0.0033 | " | 11.5 | 6.0 | " | " | " | " |
| MMC 1000 3920000 | 0.0039 | " | 12.0 | 6.5 | " | " | " | " |
| MMC 1000 4720000 | 0.0047 | " | 12.5 | 7.0 | " | " | " | " |
| MMC 1000 5620000 | 0.0056 | " | 13.0 | 7.5 | " | " | " | " |
| MMC 1000 6820000 | 0.0068 | " | 11.0 | 6.0 | " | " | " | " |
| MMC 1000 8220000 | 0.0082 | " | " | " | " | 12.5 | " | " |
| MMC 1000 1030000 | 0.010 | " | " | " | " | " | " | " |
| MMC 1000 1230000 | 0.012 | " | 12.0 | " | " | " | " | " |
| MMC 1000 1530000 | 0.015 | " | 12.5 | 7.0 | " | " | " | " |
| MMC 1000 1830000 | 0.018 | " | 13.0 | 7.5 | " | " | " | 0.8 |
| MMC 1000 2230000 | 0.022 | " | 15.5 | " | " | " | " | " |
| MMC 1000 2730000 | 0.027 | 21.0 | 13.0 | 6.0 | 17.5 | " | B | " |
| MMC 1000 3330000 | 0.033 | " | 14.0 | 6.5 | " | " | " | " |
| MMC 1000 3930000 | 0.039 | " | 14.5 | 7.0 | " | " | " | " |
| MMC 1000 4730000 | 0.047 | " | 15.5 | 7.5 | " | " | " | " |
| MMC 1000 5630000 | 0.056 | " | 17.0 | " | " | " | " | " |
| MMC 1000 6830000 | 0.068 | " | 18.0 | 8.5 | " | " | " | " |
| MMC 1000 8230000 | 0.082 | " | 18.5 | 9.0 | " | " | " | " |
| MMC 1000 1040000 | 0.10 | " | 20.0 | 10.0 | " | " | " | " |
| MMC 1000 1240000 | 0.12 | 26.0 | 18.5 | 9.0 | 22.5 | 17.5 | " | " |
| MMC 1000 1540000 | 0.15 | " | 20.0 | 10.0 | " | " | " | " |
| MMC 1000 1840000 | 0.18 | " | 22.0 | 10.5 | " | " | " | " |
| MMC 1000 2240000 | 0.22 | " | 23.0 | 12.0 | " | " | " | " |
| MMC 1000 2740000 | 0.27 | " | 25.0 | 13.5 | " | " | " | " |
| MMC 1000 3340000 | 0.33 | 31.0 | 24.0 | 13.0 | 27.5 | 22.5 | " | " |
| MMC 1000 3940000 | 0.39 | " | 26.0 | 14.0 | " | " | " | " |
| MMC 1000 4740000 | 0.47 | " | 27.5 | 15.5 | " | " | " | " |

SPECIFICATION

METALLIZED POLYESTER FILM CAPACITOR

SPEC

P S C 3 0 5 0 0 0

MMC, MMCF, MMCC - 1250V . DC

| Parts No. | Capacitance (μ F) | Dimensions (mm) | | | | | | | |
|------------------|---------------------------|-----------------|------|------|------|------|---|-----|--|
| | | W | H | T | P | F | d | | |
| MMC 1250 1020000 | 0.0010 | 15.5 | 11.0 | 6.0 | 12.5 | 10.0 | A | 0.6 | |
| MMC 1250 1220000 | 0.0012 | " | " | " | " | " | " | " | |
| MMC 1250 1520000 | 0.0015 | " | " | " | " | " | " | " | |
| MMC 1250 1820000 | 0.0018 | " | " | " | " | " | " | " | |
| MMC 1250 2220000 | 0.0022 | " | 11.5 | " | " | " | " | " | |
| MMC 1250 2720000 | 0.0027 | " | 12.0 | 6.5 | " | " | " | " | |
| MMC 1250 3320000 | 0.0033 | " | 11.5 | 6.0 | " | " | " | " | |
| MMC 1250 3920000 | 0.0039 | " | 12.0 | 6.5 | " | " | " | " | |
| MMC 1250 4720000 | 0.0047 | " | 12.5 | 7.0 | " | " | " | " | |
| MMC 1250 5620000 | 0.0056 | " | 13.0 | 7.5 | " | " | " | " | |
| MMC 1250 6820000 | 0.0068 | " | 15.0 | " | " | " | " | " | |
| MMC 1250 8220000 | 0.0082 | 21.0 | 12.0 | 5.0 | 17.5 | 12.5 | B | " | |
| MMC 1250 1030000 | 0.010 | " | 12.5 | " | " | " | " | " | |
| MMC 1250 1230000 | 0.012 | " | 13.0 | 5.5 | " | " | " | " | |
| MMC 1250 1530000 | 0.015 | " | 13.5 | 6.0 | " | " | " | " | |
| MMC 1250 1830000 | 0.018 | " | 14.5 | 6.5 | " | " | " | 0.8 | |
| MMC 1250 2230000 | 0.022 | " | 15.0 | 7.0 | " | " | " | " | |
| MMC 1250 2730000 | 0.027 | 26.0 | 15.5 | 6.0 | 22.5 | 17.5 | B | " | |
| MMC 1250 3330000 | 0.033 | " | 16.0 | 6.5 | " | " | " | " | |
| MMC 1250 3930000 | 0.039 | " | 16.5 | 7.0 | " | " | " | " | |
| MMC 1250 4730000 | 0.047 | " | 17.0 | 8.0 | " | " | " | " | |
| MMC 1250 5630000 | 0.056 | 31.0 | " | 7.5 | 27.5 | 22.5 | " | " | |
| MMC 1250 6830000 | 0.068 | " | 17.5 | 8.0 | " | " | " | " | |
| MMC 1250 8230000 | 0.082 | " | 18.5 | 9.0 | " | " | " | " | |
| MMC 1250 1040000 | 0.10 | " | 19.5 | 10.0 | " | " | " | " | |
| MMC 1250 1240000 | 0.12 | " | 20.5 | 11.5 | " | " | " | " | |
| MMC 1250 1540000 | 0.15 | " | 23.0 | 12.0 | " | " | " | " | |
| MMC 1250 1840000 | 0.18 | " | 24.5 | 13.0 | " | " | " | " | |
| MMC 1250 2240000 | 0.22 | " | 26.5 | 14.5 | " | " | " | " | |

SPECIFICATION

METALLIZED POLYESTER FILM CAPACITORS

SPEC

P S C 3 0 5 0 0 0

SPECIFICATION OF TAPING FOR AUTOMATIC INSERTION (Type MMCV)

1. SCOPE

This specification applies to the taping dimensions and performance required for film capacitors used in the automatic radial insertion system.

Style of packing : Ammo pack

2. TAPING DIMENSIONS

| Type | Taping style | STYLE-1 | STYLE-2 | STYLE-3 | STYLE-5 | STYLE-6 |
|-------|---------------|---------|---------|---------|---------|---------|
| | Rated voltage | | | | | |
| MMC V | 100V. DC | 333~474 | 564~105 | 125~225 | 564~105 | 125~225 |
| | 250V. DC | 102~154 | 184~334 | 394~125 | 184~334 | 394~155 |
| | 400V. DC | 102~333 | 393~104 | 124~474 | 393~104 | 124~474 |
| | 450V. DC | 102~333 | 393~104 | 124~474 | 393~104 | 124~474 |
| | 630V. DC | 102~822 | 103~473 | 563~224 | 103~473 | 563~224 |

3. TAPING PERFORMANCE (to be satisfied with the following point)

3-1. Appearance : To be no damages or cracks on components and the tape.

3-2. Missing components : A maximum of 3 consecutive components may be missing.

3-3. Tip of the tape : To leave the blank tape more than 4.5 feed hole pitch from the start, and the end of the tape.

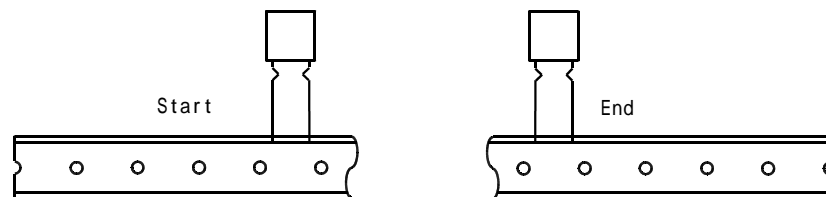

3-4. Tape splicing : Tape splicing may be done with (1) or (2).

(1) The carrier tape (include hold-down tape) shall be cut at the center of hole and hole, and spliced with tape.

(2) The carrier tape (include hold down tape) shall be cut at the center of hole, and spliced with splicing tape.

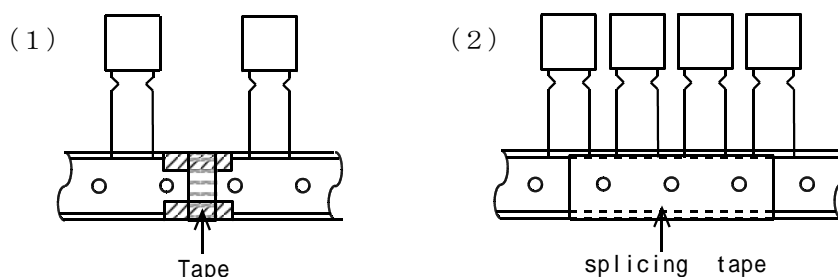

SPECIFICATION

METALLIZED POLYESTER FILM CAPACITOR

SPEC

P S C 3 0 5 0 0 0

3-5. Adhesive strength : When pulling an adhesive tape in W direction (upward) using a push-and-pull scale, adhesive strength shall be 3N or more

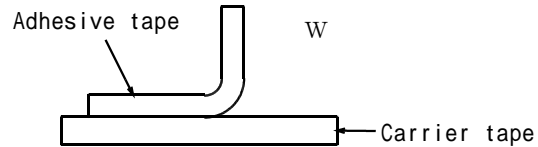

3-6. Tensile test : When pulling a test sample by the force 10N, there shall be no gaps or breakdowns.

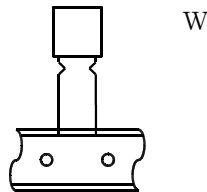

3-7. Moisture resistance : A taped test sample shall be left in a chamber with a temperature of 40°C and RH95% for 96 hours. Then after being left for one hour at room temperature the test sample shall be submitted to a tensile test of item 3.6.

3-8. Temperature cycling test : A test sample shall be submitted to 5 cycles of temperature cycling test.

One cycle consists of : 2 hours at -40°C
2 hours at +85°C

Then after being left for one hour at room temperature, the test sample shall be submitted to a tensile test of item 3.6.

4. BOX DIMENSIONS

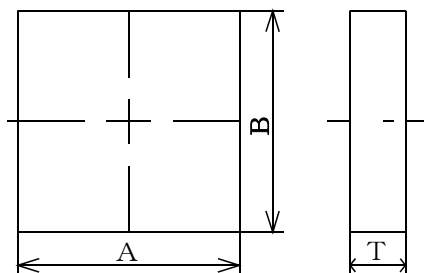

(Unit : mm)

| Type | A | B | T |
|------|---------|---------|--------|
| c | 330 ± 7 | 330 ± 7 | 45 ± 5 |
| d | 330 ± 7 | 330 ± 7 | 50 ± 5 |
| e | 330 ± 7 | 330 ± 7 | 55 ± 5 |

| | | |
|---------------|-------------------------------------|---------------------------|
| SPECIFICATION | METALLIZED POLYESTER FILM CAPACITOR | SPEC P S C 3 0 5 0 0 0 |
|---------------|-------------------------------------|---------------------------|

5. STYLE OF PACKING (Ammo pack)

5-1.Packaging

- * Fold the tape in the cardboard box, with hold-down tepe turning up against an outlet opening.
- * Thread the feed hole with a axle and fix the tape.

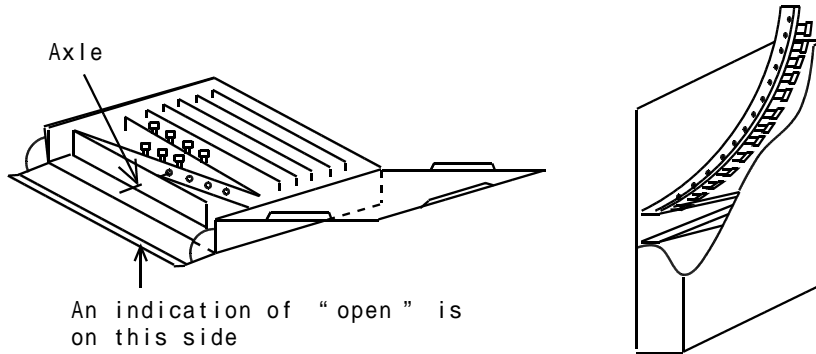

5-2.Marking

The following particulars shall be labelled on the surface of a box.

Example)

| | | | | | | | |
|---------------|--|----|--------|-----------|--|----------|--|
| CODE CUSTOMER | | | | INSP DATE | | PKG NO | |
| PARTS NO | | | | MACH NO | | QTY/PKG | |
| ORDER NO | | | LOT NO | | | ROHS | |
| TYPE | | WV | | TOL | | CAP | |
| | | | | EDP CODE | | QT (PCS) | |

| | | | |
|---------------|----------|--------------------|----------|
| CODE CUSTOMER | MACH NO | PRODUCTION COUNTRY | TOL(%) |
| INSP DATE | ORDER NO | TYPE | CAP |
| PARTS NO | LOT NO | W V | EDP CODE |
| | | | QT(PCS) |

| | | |
|---------------|-------------------------------------|-------------------|
| | | SPEC |
| SPECIFICATION | METALLIZED POLYESTER FILM CAPACITOR | P S C 3 0 5 0 0 0 |

| | | |
|--|---|--|
| Type M M C V S T Y L E - 1 (0 2 0 0) | 333 ~ 474 102 ~ 154 102 ~ 333 102 ~ 333 102 ~ 822 | 100V. DC 250V. DC 400V. DC 450V. DC 630V. DC |
|--|---|--|

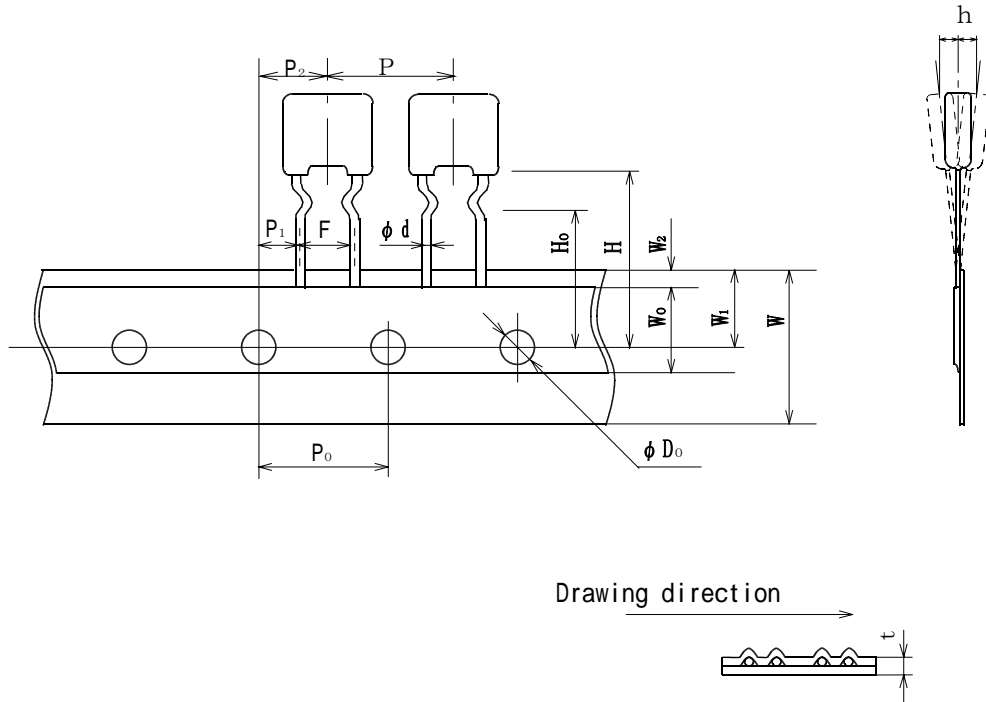

(Unit : mm)

| P | P ₀ | (1) P ₁ | P ₂ | d | (1) F | (2) h | W | W ₀ | W ₁ | (3) W ₂ | H | (1) H ₀ | D ₀ | t |
|------|----------------|-----------------------|----------------|---------------|----------------------|----------|----------------------|----------------|----------------|-----------------------|--------------|-----------------------|----------------|------|
| 12.7 | 12.7 | 3.85 | 6.35 | 0.5 or 0.6 | 5.0 | 0 | 18.0 | 5.0 | 9.0 | 3.0 Max | 21.25 Max | 16.0 | 4.0 | 0.7 |
| ±1.0 | ±0.3 | ±0.7 | ±1.3 | ±0.05 | $\pm 0. \frac{8}{2}$ | ±2.0 | $\pm 1. \frac{0}{5}$ | — | ±0.5 | — | — | ±0.5 | ±0.2 | ±0.2 |

- (1) To be measured under the clinch-position.
- (2) To be measured the top of component.
- (3) Hold-down tape is not to exceed over the carrier tape.

| | | |
|---------------|-------------------------------------|-------------------|
| | | SPEC |
| SPECIFICATION | METALLIZED POLYESTER FILM CAPACITOR | P S C 3 0 5 0 0 0 |

| | | |
|------------|-----------|----------|
| Type MMC V | 564 ~ 105 | 100V. DC |
| STYLE - 2 | 184 ~ 334 | 250V. DC |
| (D 2 0 0) | 393 ~ 104 | 400V. DC |
| | 393 ~ 104 | 450V. DC |
| | 103 ~ 473 | 630V. DC |

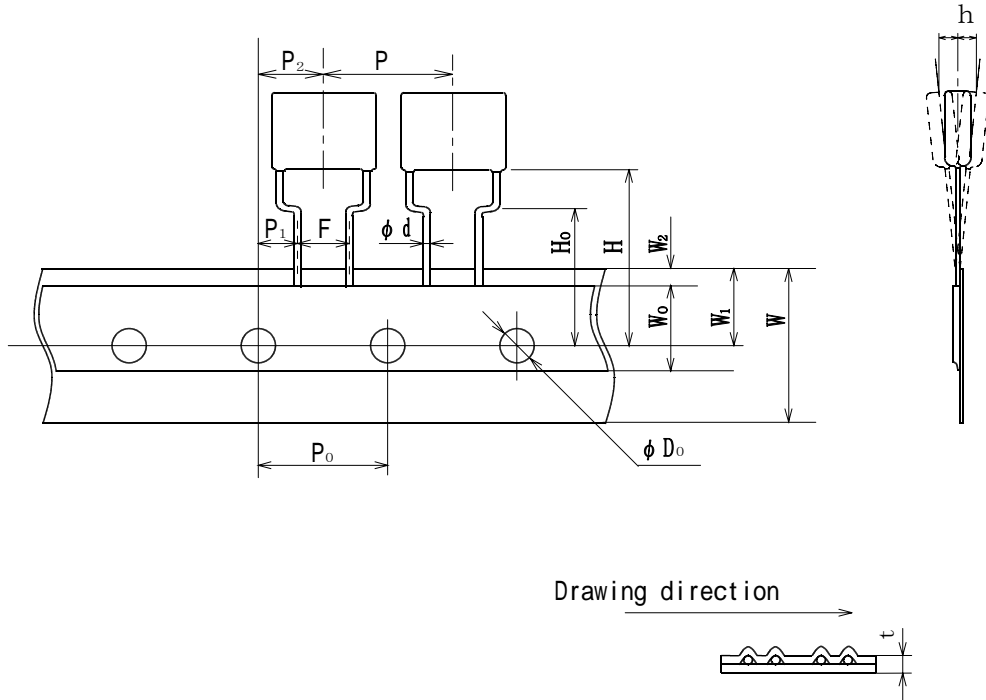

(Unit : mm)

| P | P ₀ | (1) P ₁ | P ₂ | d | (1) F | (2) h | W | W ₀ | W ₁ | (3) W ₂ | H | (1) H ₀ | D ₀ | t |
|------|----------------|-----------------------|----------------|---------------|--------------|----------|--------------|----------------|----------------|-----------------------|-------------|-----------------------|----------------|------|
| 15.0 | 15.0 | 5.0 | 7.5 | 0.6 or 0.8 | 5.0 | 0 | 18.0 | 5.0 | 9.0 | 3.0 Max | 22.0 Max | 16.0 | 4.0 | 0.7 |
| ±1.0 | ±0.3 | ±0.7 | ±1.3 | ±0.05 | ±0.8 ±0.2 | ±2.0 | ±1.0 ±0.5 | — | ±0.5 | — | — | ±0.5 | ±0.2 | ±0.2 |

- (1) To be measured under the clinch-position.
- (2) To be measured the top of component.
- (3) Hold-down tape is not to exceed over the carrier tape.

| | | |
|---------------|-------------------------------------|-------------------|
| SPECIFICATION | METALLIZED POLYESTER FILM CAPACITOR | SPEC |
| | | P S C 3 0 5 0 0 0 |

| | | |
|------------|-----------|----------|
| Type MMC V | 125 ~ 225 | 100V. DC |
| STYLE - 3 | 394 ~ 125 | 250V. DC |
| (D 2 1 0) | 124 ~ 474 | 400V. DC |
| | 124 ~ 474 | 450V. DC |
| | 563 ~ 224 | 630V. DC |

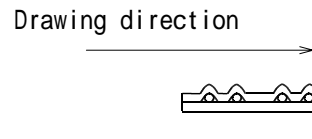
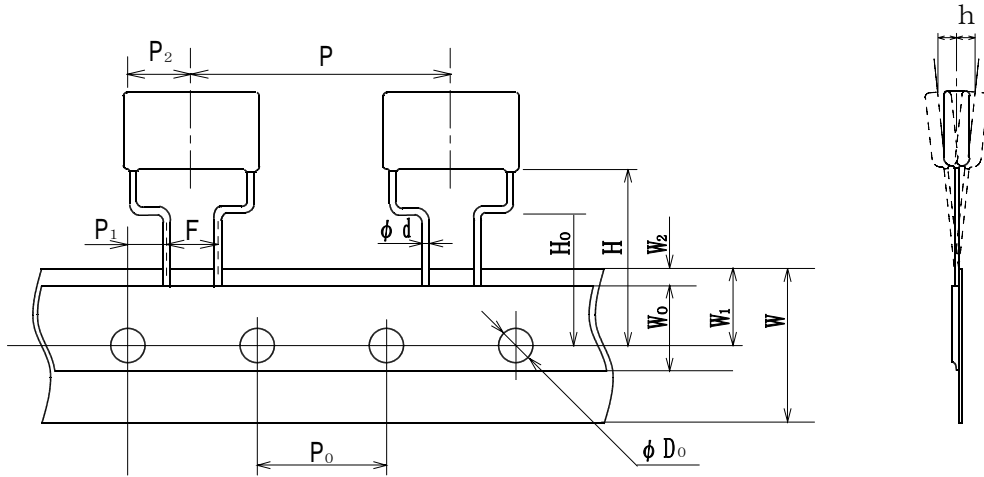

(Unit : mm)

| P | P ₀ | (1) P ₁ | P ₂ | d | (1) F | (2) h | W | W ₀ | W ₁ | (3) W ₂ | H | (1) H ₀ | D ₀ | t |
|------|----------------|-----------------------|----------------|---------------|--------------|----------|--------------|----------------|----------------|-----------------------|-------------|-----------------------|----------------|------|
| 25.4 | 12.7 | 3.85 | 6.35 | 0.6 or 0.8 | 5.0 | 0 | 18.0 | 5.0 | 9.0 | 3.0 Max | 22.0 Max | 16.0 | 4.0 | 0.7 |
| ±1.0 | ±0.3 | ±0.7 | ±1.3 | ±0.05 | +0.8 -0.2 | ±2.0 | +1.0 -0.5 | — | ±0.5 | — | — | ±0.5 | ±0.2 | ±0.2 |

- (1) To be measured under the clinch-position.
- (2) To be measured the top of component.
- (3) Hold-down tape is not to exceed over the carrier tape.

| | | |
|---------------|-------------------------------------|-------------------|
| SPECIFICATION | METALLIZED POLYESTER FILM CAPACITOR | SPEC |
| | | P S C 3 0 5 0 0 0 |

| | | |
|-----------|-----------|----------|
| Type MMCV | 564 ~ 105 | 100V. DC |
| STYLE-5 | 184 ~ 334 | 250V. DC |
| (0200) | 393 ~ 104 | 400V. DC |
| | 393 ~ 104 | 450V. DC |
| | 103 ~ 473 | 630V. DC |

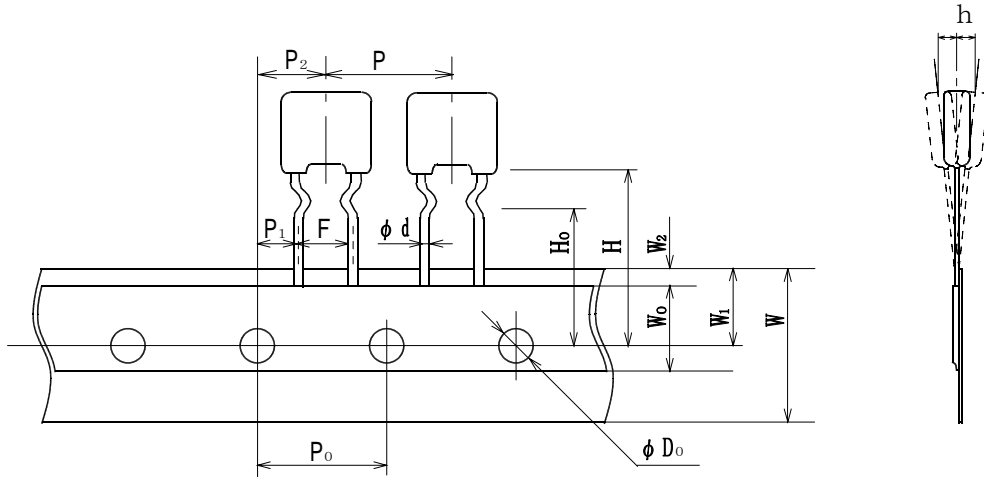

Drawing direction →

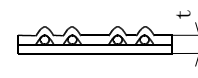

(Unit : mm)

| P | P ₀ | (1) P ₁ | P ₂ | d | (1) F | (2) h | W | W ₀ | W ₁ | (3) W ₂ | H | (1) H ₀ | D ₀ | t |
|------|----------------|-----------------------|----------------|---------------|--------------|----------|--------------|----------------|----------------|-----------------------|-------------|-----------------------|----------------|------|
| 15.0 | 15.0 | 3.75 | 7.5 | 0.6 or 0.8 | 7.5 | 0 | 18.0 | 5.0 | 9.0 | 3.0 Max | 22.0 Max | 16.0 | 4.0 | 0.7 |
| ±1.0 | ±0.3 | ±0.7 | ±1.3 | ±0.05 | +0.8 -0.2 | ±2.0 | +1.0 -0.5 | — | ±0.5 | — | — | ±0.5 | ±0.2 | ±0.2 |

- (1) To be measured under the clinch-position.
- (2) To be measured the top of component.
- (3) Hold-down tape is not to exceed over the carrier tape.

| SPECIFICATION | METALLIZED POLYESTER FILM CAPACITOR | SPEC |
|---------------|-------------------------------------|-------------------|
| | | P S C 3 0 5 0 0 0 |

| | | |
|------------|-----------|----------|
| Type MMC V | 125 ~ 225 | 100V. DC |
| STYLE - 6 | 394 ~ 155 | 250V. DC |
| (0200) | 124 ~ 474 | 400V. DC |
| | 124 ~ 474 | 450V. DC |
| | 563 ~ 224 | 630V. DC |

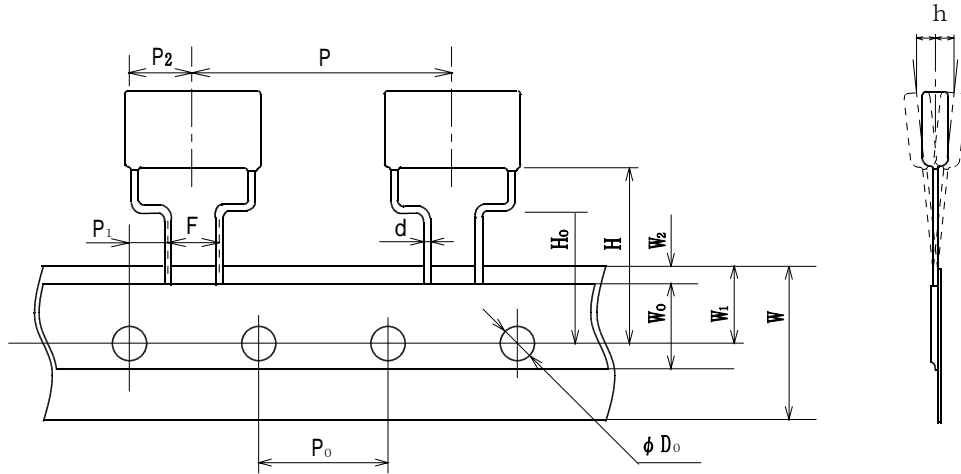

Drawing direction

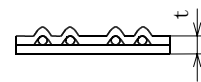

(Unit : mm)

| P | P ₀ | (1) P ₁ | P ₂ | d | (1) F | (2) h | W | W ₀ | W ₁ | (3) W ₂ | H | (1) H ₀ | D ₀ | t |
|------|----------------|-----------------------|----------------|---------------|----------------------|----------|----------------------|----------------|----------------|-----------------------|-------------|-----------------------|----------------|------|
| 30.0 | 15.0 | 3.75 | 7.5 | 0.6 or 0.8 | 7.5 | 0 | 18.0 | 5.0 | 9.0 | 3.0 Max | 22.0 Max | 16.0 | 4.0 | 0.7 |
| ±1.0 | ±0.3 | ±0.7 | ±1.3 | ±0.05 | $\pm 0. \frac{8}{2}$ | ±2.0 | $\pm 1. \frac{0}{5}$ | — | ±0.5 | — | — | ±0.5 | ±0.2 | ±0.2 |

(1) To be measured under the clinch-position.

(2) To be measured the top of component.

(3) Hold-down tape is not to exceed over the carrier tape.

SPECIFICATION

METALLIZED POLYESTER FILM CAPACITOR

SPEC

P S C 3 0 5 0 0 0

Packing quantity

MMCV-100V. DC

(Unit : pcs)

| Capacitance (μ F) | STYLE-1 (0200) | STYLE-2 (D200) | STYLE-3 (D210) | STYLE-5 (0200) | STYLE-6 (0200) |
|---------------------------|-------------------|-------------------|-------------------|-------------------|-------------------|
| 0.033 | 2,000 | | | | |
| 0.039 | " | | | | |
| 0.047 | " | | | | |
| 0.056 | " | | | | |
| 0.068 | " | | | | |
| 0.082 | " | | | | |
| 0.10 | " | | | | |
| 0.12 | " | | | | |
| 0.15 | " | | | | |
| 0.18 | 1,000 | | | | |
| 0.22 | " | | | | |
| 0.27 | " | | | | |
| 0.33 | " | | | | |
| 0.39 | " | | | | |
| 0.47 | " | | | | |
| 0.56 | | 1,000 | | 1,000 | |
| 0.68 | | 500 | | 500 | |
| 0.82 | | " | | " | |
| 1.0 | | " | | " | |
| 1.2 | | | 500 | | 500 |
| 1.5 | | | " | | " |
| 1.8 | | | " | | 400 |
| 2.2 | | | 400 | | " |

SPECIFICATION

METALLIZED POLYESTER FILM CAPACITOR

SPEC

P S C 3 0 5 0 0 0

Packing quantity

MMCV-250V. DC

(Unit : pcs)

| Capacitance (μ F) | STYLE-1 (0200) | STYLE-2 (D200) | STYLE-3 (D210) | STYLE-5 (0200) | STYLE-6 (0200) |
|---------------------------|-------------------|-------------------|-------------------|-------------------|-------------------|
| 0.0010 | 1,000 | | | | |
| 0.0012 | " | | | | |
| 0.0015 | " | | | | |
| 0.0018 | " | | | | |
| 0.0022 | " | | | | |
| 0.0027 | " | | | | |
| 0.0033 | " | | | | |
| 0.0039 | " | | | | |
| 0.0047 | " | | | | |
| 0.0056 | " | | | | |
| 0.0068 | " | | | | |
| 0.0082 | " | | | | |
| 0.010 | " | | | | |
| 0.012 | " | | | | |
| 0.015 | " | | | | |
| 0.018 | " | | | | |
| 0.022 | " | | | | |
| 0.027 | " | | | | |
| 0.033 | " | | | | |
| 0.039 | " | | | | |
| 0.047 | " | | | | |
| 0.056 | " | | | | |
| 0.068 | " | | | | |
| 0.082 | " | | | | |
| 0.10 | " | | | | |
| 0.12 | " | | | | |
| 0.15 | " | | | | |
| 0.18 | | 1,000 | | 1,000 | |
| 0.22 | | " | | " | |
| 0.27 | | " | | " | |
| 0.33 | | 500 | | 500 | |
| 0.39 | | | 500 | | 500 |
| 0.47 | | | " | | " |
| 0.56 | | | " | | " |
| 0.68 | | | " | | " |
| 0.82 | | | " | | 400 |
| 0.90 | | | " | | " |
| 1.0 | | | 400 | | " |
| 1.2 | | | " | | " |
| 1.5 | | | | | 300 |

SPECIFICATION

METALLIZED POLYESTER FILM CAPACITOR

SPEC

P S C 3 0 5 0 0 0

Packing quantity

MMCV-400V. DC

(Unit : pcs)

| Capacitance (μ F) | STYLE-1 (0200) | STYLE-2 (D200) | STYLE-3 (D210) | STYLE-5 (0200) | STYLE-6 (0200) |
|---------------------------|-------------------|-------------------|-------------------|-------------------|-------------------|
| 0.0010 | 1,000 | | | | |
| 0.0012 | " | | | | |
| 0.0015 | " | | | | |
| 0.0018 | " | | | | |
| 0.0022 | " | | | | |
| 0.0027 | " | | | | |
| 0.0033 | " | | | | |
| 0.0039 | " | | | | |
| 0.0047 | " | | | | |
| 0.0056 | " | | | | |
| 0.0068 | " | | | | |
| 0.0082 | " | | | | |
| 0.010 | " | | | | |
| 0.012 | " | | | | |
| 0.015 | " | | | | |
| 0.018 | " | | | | |
| 0.022 | " | | | | |
| 0.027 | " | | | | |
| 0.033 | " | | | | |
| 0.039 | | 1,000 | | 1,000 | |
| 0.047 | | " | | " | |
| 0.056 | | " | | " | |
| 0.068 | | " | | " | |
| 0.082 | | " | | " | |
| 0.10 | | " | | " | |
| 0.12 | | | 500 | | 500 |
| 0.15 | | | " | | " |
| 0.18 | | | " | | " |
| 0.22 | | | " | | 400 |
| 0.27 | | | " | | " |
| 0.33 | | | 400 | | 300 |
| 0.39 | | | " | | " |
| 0.47 | | | " | | " |

SPECIFICATION

METALLIZED POLYESTER FILM CAPACITOR

SPEC

P S C 3 0 5 0 0 0

Packing quantity

MMCV-450V. DC

(Unit : pcs)

| Capacitance (μ F) | STYLE-1 (0200) | STYLE-2 (D200) | STYLE-3 (D210) | STYLE-5 (0200) | STYLE-6 (0200) |
|---------------------------|-------------------|-------------------|-------------------|-------------------|-------------------|
| 0.0010 | 1,000 | | | | |
| 0.0012 | " | | | | |
| 0.0015 | " | | | | |
| 0.0018 | " | | | | |
| 0.0022 | " | | | | |
| 0.0027 | " | | | | |
| 0.0033 | " | | | | |
| 0.0039 | " | | | | |
| 0.0047 | " | | | | |
| 0.0056 | " | | | | |
| 0.0068 | " | | | | |
| 0.0082 | " | | | | |
| 0.010 | " | | | | |
| 0.012 | " | | | | |
| 0.015 | " | | | | |
| 0.018 | " | | | | |
| 0.022 | " | | | | |
| 0.027 | " | | | | |
| 0.033 | " | | | | |
| 0.039 | | 1,000 | | 1,000 | |
| 0.047 | | " | | " | |
| 0.056 | | " | | " | |
| 0.068 | | " | | " | |
| 0.082 | | " | | " | |
| 0.10 | | " | | " | |
| 0.12 | | | 500 | | 500 |
| 0.15 | | | " | | " |
| 0.18 | | | " | | " |
| 0.22 | | | " | | 400 |
| 0.27 | | | " | | " |
| 0.33 | | | 400 | | 300 |
| 0.39 | | | " | | " |
| 0.47 | | | " | | " |

SPECIFICATION

METALLIZED POLYESTER FILM CAPACITOR

SPEC

P S C 3 0 5 0 0 0

Packing quantity

MMCV-630V. DC

(Unit : pcs)

| Capacitance (μ F) | STYLE-1 (0200) | STYLE-2 (D200) | STYLE-3 (D210) | STYLE-5 (0200) | STYLE-6 (0200) |
|---------------------------|-------------------|-------------------|-------------------|-------------------|-------------------|
| 0.0010 | 1,000 | | | | |
| 0.0012 | " | | | | |
| 0.0015 | " | | | | |
| 0.0018 | " | | | | |
| 0.0022 | " | | | | |
| 0.0027 | " | | | | |
| 0.0033 | " | | | | |
| 0.0039 | " | | | | |
| 0.0047 | " | | | | |
| 0.0056 | " | | | | |
| 0.0068 | " | | | | |
| 0.0082 | " | | | | |
| 0.010 | | 1,000 | | 1,000 | |
| 0.012 | | " | | " | |
| 0.015 | | " | | " | |
| 0.018 | | " | | " | |
| 0.022 | | " | | " | |
| 0.027 | | " | | " | |
| 0.033 | | " | | " | |
| 0.039 | | " | | " | |
| 0.047 | | 500 | | 500 | |
| 0.056 | | | 500 | | 500 |
| 0.068 | | | " | | " |
| 0.082 | | | " | | 400 |
| 0.10 | | | " | | " |
| 0.12 | | | " | | " |
| 0.15 | | | 400 | | 300 |
| 0.18 | | | " | | " |
| 0.22 | | | " | | " |



Cautions about safety In use of Capacitors

(MMC type)

Registry

HWC 3 0 5 0 0 0

Rev.

0 2

Sheet

1 / 2

When using a capacitor, please use one within the range of the specified values in the specification after checking the environments of using and mounting.

If used beyond the range specified in the specification or the attached cautions, it may lead to short circuit, open, smoking and firing.

Be sure to inquire of us as to the items which are not specified in the specification or are unclear to you.

Also, in case of using capacitors for such equipment or apparatus as may possibly affect human lives like life-support systems, aircraft and automotive control system, etc., please never fail to inquire of us as to further details.

1. Operating temperature and humidity

- (1) In actual use, make sure that the operating temperature is within the range specified in the specification.
- (2) Even if the operating temperature is within the specified range, sudden change in the operating temperature may lead to cracks on the enclosure and result in deterioration of the insulation resistance or the increase in tangent of loss angle by absorbing moisture through cracks on the enclosure. Please take good care of the operating temperature.
- (3) Please avoid using a capacitor in high humidity which may lead to the condensation as much as possible.

Even if there are no cracks or damage on an enclosure, deterioration of the insulation resistance or the increase in tangent of loss angle, etc. may be caused by absorbing moisture. Therefore, please be careful when using a capacitor.

2. When using a capacitor in a circuit except a d.c. one

When using a capacitor in a circuit except a d.c. one, a capacitor shall be used below the permissible current to frequency.

When used beyond the specified values, the capacitor surface temperature may rise due to the occurrence of corona charge or self heat generation of a capacitor and it may result in a short life, the destruction of the dielectric or the lowering of the insulation resistance.

At worst smoking or firing may be led.

3. Soldering

When soldering a capacitor, heat in soldering is conducted to the inside of the capacitor through lead wires and an enclosure.

Therefore soldering at high temperature and for hours may cause deterioration of characteristics or breakdown of a capacitor.

Be sure to solder a capacitor within the range specified in the specification when soldering.

In case of soldering beyond the range recommended by us, please inquire of us as to the details in advance.

- (1) Avoid soldering over again in a short time.

When dipping again in order to correct, dipping must be applied after the temperature of a capacitor comes down to a room temperature and within twice.

- (2) Avoid any work that puts the stress on lead wires of a capacitor such as correction of the position right after soldering.
- (3) When soldering with a soldering iron, please see to it lest a soldering iron should touch the body of a capacitor directly.

| | | | |
|---|---|----------------|-----------------------------|
|  | Cautions about safety In use of Capacitors (MMC type) | | Registry HWC 3 0 5 0 0 0 |
| | Rev. 0 2 | Sheet 2 / 2 | |

4. Mounting

- (1) When inserting a lead wire into the printed circuit board, the stress put on a lead wire shall be within the following range.

Bending of lead wire

When bending a lead wire vertically and then restoring straight, bending of a lead wire in the same place shall be less than two cycles. (One cycle -- bending at 90° and restoring straight)

Twisting of lead wire

Twisting of a lead wire should be carried out within a turn (a 360° turn) in total.

Pulling of lead wire

The load in pulling of a lead wire shall be less than 20N.

In case that the above stress is combined together, the value in application should be set less than half of each value.

- (2) When mounting a capacitor by force owing to the difference of the space between lead wires of a capacitor from the space between the holes on the printed circuit board, be careful. It may cause breakage of a lead wire or cracks on coating resin.
- (3) When mounting a capacitor of large size or a capacitor on the equipment affected by vibrations, fix the body of a capacitor with resin etc. which has no effect on a capacitor. However, resin used for fixing shall be a flame retardant and minimum.
- (4) Mount a capacitor lest it should touch other parts.
Especially in case of touching a part with self heat generation, a capacitor may deteriorate due to heat and short circuit may be easily caused owing to lowering of dielectric strength or deterioration of the insulation resistance, etc..

5. Cleaning

- (1) When using the solvents for cleaning, use alcohol derivative cleaning solvents (isopropyl alcohol, etc).
- (2) Since a small amount of ingredient contained in flux may lead to corrosion of terminations of the capacitor or chemical change of the capacitor element, be sure to clean a printed circuit board right after soldering.
- (3) The temperature for drying after cleaning shall be less than the maximum operating temperature.
- (4) When cleaning with solvents but alcohol derivatives, please inquire of us in advance.

6. Storing and waste

- (1) Store under the conditions not exceeding -10 °C ~ +40 °C, 75%RH in the room and avoid storing in the place filled with a sudden change in the temperature, the direct sunlight or corrosive gases (hydrogen sulfide, sulfurous acid, chlorine and ammonia, etc.).
- (2) A long-term storage may cause deterioration of characteristics of a capacitor due to absorbing moisture little by little.
Therefore, be sure to use after checking its characteristics and solderability if stored for over one year.
- (3) As capacitors are classified into industrial waste, please ask experts to dispose of them.

7. The others

Please refer to "Guideline of notabilia for fixed plastic film capacitors for use in electronic equipment" published by Electronic Industries Association of Japan (EIAJ RCR-2350) unless specified in the specification.