

DATA SHEET

SURFACE-MOUNT CERAMIC MULTILAYER CAPACITORS

Mid-voltage

NP0/X7R

100 V TO 630 V

0.47 pF to 2.2 μ F

RoHS compliant & Halogen Free



SCOPE

This specification describes Mid-voltage NP0/X7R series chip capacitors with lead-free terminations.

APPLICATIONS

PCs, Hard disk, Game PCs
Power supplies
LCD panel
ADSL, Modem

FEATURES

Supplied in tape on reel
Nickel-barrier end termination
RoHS compliant
Halogen Free compliant

ORDERING INFORMATION - GLOBAL PART NUMBER, PHYCOMP CTC & I2NC

All part numbers are identified by the series, size, tolerance, TC material, packing style, voltage, process code, termination and capacitance value.

YAGEO BRAND ordering code

GLOBAL PART NUMBER (PREFERRED)

CC XXXX X X XXX X **B** X XXX
(1) (2) (3) (4) (5) (6) (7)

(1) SIZE – INCH BASED (METRIC)

0201 (0603) / 0402 (1005) / 0603 (1608) / 0805 (2012) / 1206 (3216) / 1210 (3225) / 1808 (4520) / 1812 (4532)

(2) TOLERANCE

C = ±0.25 pF
D = ±0.5 pF
F = ±1%
G = ±2%
J = ±5%
K = ±10%
M = ±20%

(3) PACKING STYLE

R = Paper/PE taping reel; Reel 7 inch
K = Blister taping reel; Reel 7 inch
P = Paper/PE taping reel; Reel 13 inch
F = Blister taping reel; Reel 13 inch
C = Bulk case

(4) TC MATERIAL

NPO
X7R

(5) RATED VOLTAGE

0 = 100 V
A = 200 V
Y = 250 V
B = 500 V
Z = 630 V

(6) PROCESS

N = NPO
B = Class 2 MLCC

(7) CAPACITANCE VALUE

2 significant digits+number of zeros
The 3rd digit signifies the multiplying factor, and letter R is decimal point
Example: 121 = 12 × 10¹ = 120 pF

CONSTRUCTION

The capacitor consists of a rectangular block of ceramic dielectric in which a number of interleaved metal electrodes are contained. This structure gives rise to a high capacitance per unit volume.

The inner electrodes are connected to the two end terminations and finally covered with a layer of plated tin (NiSn). The terminations are lead-free. A cross section of the structure is shown in Fig.1.



Fig. 1 Surface mounted multilayer ceramic capacitor construction

DIMENSION

Table I For outlines see fig. 2

TYPE	L ₁ (mm)	W (mm)	T (MM)	L ₂ / L ₃ (mm)		L ₄ (mm)
				min.	max.	min.
0201	0.6 ±0.03	0.3±0.03	0.3±0.03	0.10	0.20	0.20
0402	1.0 ±0.05	0.5 ±0.05	0.5 ±0.05	0.15	0.30	0.40
0603	1.6 ±0.10	0.8 ±0.10	0.8 ±0.10	0.20	0.60	0.40
0805	2.0 ±0.20	1.25 ±0.20	0.6 ±0.10	0.25	0.75	0.70
			0.85 ±0.10			
1206	3.2 ±0.30	1.6 ±0.20	0.6 ±0.10	0.25	0.75	1.40
			0.85 ±0.10			
			1.25 ±0.20			
			1.6 ±0.20			
	3.2 ±0.30	1.6 ±0.30	1.6 ±0.30			
1210	3.2 ±0.30	2.5 ±0.20	0.85 ±0.10	0.25	0.75	1.40
			1.25 ±0.20			
			2.0 ±0.20			
1808	4.5 ±0.40	2.0 ±0.30	1.25 ±0.20	0.25	0.75	2.20
1812	4.5 ±0.40	3.2 ±0.30	0.85 ±0.10	0.25	0.75	2.20
			1.25 ±0.20			
			1.6 ±0.20			

OUTLINES

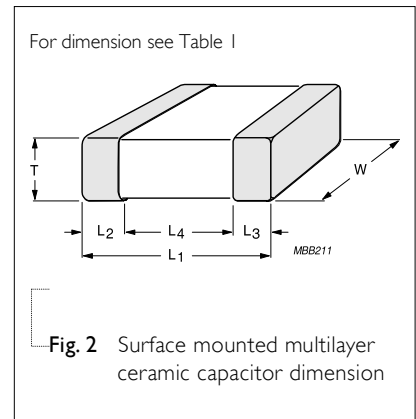

Fig. 2 Surface mounted multilayer ceramic capacitor dimension

CAPACITANCE RANGE & THICKNESS FOR NP0

Table 2 Sizes from 0201 to 0805

CAP.	0201	0402	0603		0805					
	100V	100V	100 V	200 V	250 V	100 V	200 V	250 V	500 V	630V
0.22 pF										
0.47 pF										
0.56 pF										
0.68 pF										
0.82 pF										
1.0 pF										
1.2 pF										
1.5 pF										
1.8 pF										
2.2 pF										
2.7 pF										
3.3 pF										
3.9 pF										
4.7 pF										
5.6 pF	0.3±0.03	0.5±0.05	0.8±0.1	0.8±0.1	0.8±0.1	0.6±0.1	0.6±0.1	0.6±0.1	0.6±0.1	0.6±0.1
6.8 pF										
8.2 pF										
10 pF										
12 pF										
15 pF										
18 pF										
22 pF										
27 pF										
33 pF										
39 pF										
47 pF										
56 pF										
68 pF										
82 pF										
100 pF										

NOTE

1. Values in shaded cells indicate thickness class in mm
2. Capacitance value of non E-12 series is on request

CAPACITANCE RANGE & THICKNESS FOR NP0

Table 4 Sizes from 0603 to 0805 (continued)

CAP.	0402		0603		0805				
	100 V	100 V	200 V	250 V	100 V	200 V	250 V	500 V	630 V
120 pF									
150 pF						0.6± 0.1	0.6± 0.1	0.6± 0.1	0.6± 0.1
180 pF									
220 pF									
270 pF			0.8± 0.1	0.8± 0.1					
330 pF	0.5± 0.05				0.6± 0.1			0.85±0.1	0.85±0.1
390 pF		0.8± 0.1				0.85±0.1	0.85±0.1		
470 pF									
560 pF									
680 pF								1.25±0.2	1.25±0.2
820 pF									
1.0 nF									
1.2 nF									
1.5 nF					0.85±0.1				
1.8 nF									
2.2 nF						1.25±0.2	1.25±0.2		
2.7 nF									
3.3 nF									
3.9 nF									
4.7 nF					1.25±0.2				
5.6 nF									
6.8 nF									
8.2 nF									
10 nF									
12 nF									
15 nF									
18 nF									
22 nF									

NOTE

1. Values in shaded cells indicate thickness class in mm
2. Capacitance value of non E-12 series is on request

CAPACITANCE RANGE & THICKNESS FOR NP0

Table 5 Sizes from 1206 to 1210

CAP.	1206					1210				
	100 V	200 V	250 V	500 V	630 V	100 V	200 V	250 V	500 V	630 V
0.47 pF										
0.56 pF										
0.68 pF										
0.82 pF										
1.0 pF										
1.2 pF										
1.5 pF										
1.8 pF										
2.2 pF										
2.7 pF										
3.3 pF										
3.9 pF										
4.7 pF										
5.6 pF										
6.8 pF	0.6±0.1	0.6±0.1	0.6±0.1							
8.2 pF										
10 pF										
12 pF										
15 pF										
18 pF										
22 pF										
27 pF										
33 pF				0.6±0.1	1.25±0.2					
39 pF										
47 pF										
56 pF										1.25±0.2
68 pF						1.25±0.2	1.25±0.2	1.25±0.2	1.25±0.2	
82 pF										

NOTE

1. Values in shaded cells indicate thickness class in mm
2. Capacitance value of non E-12 series is on request

CAPACITANCE RANGE & THICKNESS FOR NP0

Table 7 Sizes from 1206 to 1210 (continued)

CAP.	1206					1210				
	100 V	200 V	250 V	500 V	630 V	100 V	200 V	250 V	500 V	630 V
100 pF										
120 pF										
150 pF										
180 pF										
220 pF										
270 pF		0.6±0.1	0.6±0.1	0.6±0.1						
330 pF										1.25±0.2
390 pF					1.25±0.2					
470 pF	0.6±0.1									
560 pF	0.6±0.1									
680 pF							1.25±0.2	1.25±0.2	1.25±0.2	
820 pF										
1.0 nF		0.85±0.1	0.85±0.1	0.85±0.1		1.25±0.2				
1.2 nF		0.85±0.1	0.85±0.1	0.85±0.1						
1.5 nF										
1.8 nF										
2.2 nF		1.25±0.2	1.25±0.2	1.25±0.2						
2.7 nF										
3.3 nF										
3.9 nF										
4.7 nF	0.85±0.1									
5.6 nF										
6.8 nF										
8.2 nF										
10 nF	1.25±0.2									
12 nF										
15 nF										
18 nF						1.6±0.2				
22 nF										

NOTE

1. Values in shaded cells indicate thickness class in mm
2. Capacitance value of non E-12 series is on request

CAPACITANCE RANGE & THICKNESS FOR NP0

Table 8 Sizes 1812

CAP.	1812					
	100 V	200 V	250 V	500 V	630V	
10 pF						
12 pF						
15 pF						
18 pF						
22 pF						
27 pF						
33 pF						
39 pF						
47 pF						
56 pF						
68 pF						
82 pF						
100 pF						
120 pF						
150 pF						
180 pF						
220 pF						
270 pF						
330 pF						1.25±0.2
390 pF						
470 pF						
560 pF					1.25±0.2	
680 pF						
820 pF						
1 nF						
1.2 nF				1.25±0.2	1.25±0.2	
1.5 nF						
1.8 nF						
2.2 nF						
2.7 nF		1.25±0.2				
3.3 nF						
3.9 nF						
4.7 nF						
5.6 nF						
6.8 nF						
8.2 nF						
10 nF						
12 nF						
15 nF						
18 nF						
22 nF						

NOTE

1. Values in shaded cells indicate thickness class in mm
2. Capacitance value of non E-12 series is on request

CAPACITANCE RANGE & THICKNESS FOR X7R

Table 10 Sizes from 0402 to 0805

CAP.	0402		0603		0805			
	100 V	100 V	250 V	100 V	200 V	250 V	500 V	630 V
100 pF								
150 pF								
220 pF								
330 pF								
470 pF								
680 pF								
1.0 nF	0.5±0.05				0.85±0.1	0.85±0.1	0.85±0.1	0.85±0.1
1.5 nF				0.6±0.1				
2.2 nF			0.8±0.1					
3.3 nF		0.8±0.1						
4.7 nF								
6.8 nF								
10 nF								1.25±0.2
15 nF				0.85±0.1	1.25±0.2	1.25±0.2	1.25±0.2	
22 nF								
33 nF								
47 nF								
68 nF								
100 nF				1.25±0.2				
150 nF								
220 nF								
330 nF								
470 nF								

NOTE

1. Values in shaded cells indicate thickness class in mm
2. Capacitance value of non E-6 series is on request
3. For special ordering code, please contact local sales force before order
4. For product with 5% tolerance, please contact local sales force before order

CAPACITANCE RANGE & THICKNESS FOR X7R

Table 11 Sizes from 1206 to 1210

CAP.	1206					1210				
	100 V	200 V	250 V	500 V	630 V	100 V	200 V	250 V	500 V	630V
100 pF										
150 pF										
220 pF										
330 pF										
470 pF										
680 pF										
1.0 nF										
1.5 nF										
2.2 nF		0.85±0.1	0.85±0.1	1.25±0.2	1.25±0.2					
3.3 nF	0.85±0.1									
4.7 nF							0.85±0.1	0.85±0.1		
6.8 nF										
10 nF									1.25±0.2	1.25±0.2
15 nF						0.85±0.1			1.25±0.2	
22 nF										
33 nF		1.25±0.2	1.25±0.2	1.6±0.2	1.6±0.2					1.6±0.2
47 nF										
68 nF							1.25±0.2	1.25±0.2		
100 nF		1.6±0.2	1.6±0.2							
150 nF	1.25±0.2									
220 nF										
330 nF						1.25±0.2				
470 nF	1.6±0.2									
680 nF										
1 µF	1.6±0.2					2.0±0.2				
2.2 µF	1.6±0.3									

NOTE

1. Values in shaded cells indicate thickness class in mm
2. Capacitance value of non E-6 series is on request
3. For product with 5% tolerance, please contact local sales force before order

CAPACITANCE RANGE & THICKNESS FOR X7R

Table 12 Sizes from 1808 to 1812

CAP.	1808				1812				
	100 V	200 V	250 V	500 V	100 V	200 V	250 V	500 V	630 V
100 pF									
150 pF									
220 pF									
330 pF									
470 pF									
680 pF									
1.0 nF									
1.5 nF									
2.2 nF									
3.3 nF									
4.7 nF									1.35±0.2
6.8 nF						0.85±0.1	0.85±0.1		
10 nF					0.85±0.1			1.25±0.2	
15 nF	1.25±0.2	1.25±0.2	1.25±0.2	1.25±0.2					
22 nF									
33 nF									1.6±0.2
47 nF									
68 nF									
100 nF						1.25±0.2	1.25±0.2	1.6±0.2	
150 nF					1.25±0.2				
220 nF									
330 nF						1.6±0.2	1.6±0.2		
470 nF									
680 nF					1.6±0.2				
1 µF									

NOTE

1. Values in shaded cells indicate thickness class in mm
2. Capacitance value of non E-6 series is on request
3. For product with 5% tolerance, please contact local sales force before order

THICKNESS CLASSES AND PACKING QUANTITY

Table 13

SIZE CODE	THICKNESS CLASSIFICATION	TAPE WIDTH QUANTITY PER REEL	Ø180 MM / 7 INCH		Ø330 MM / 13 INCH		QUANTITY PER BULK CASE
			Paper	Blister	Paper	Blister	
0201	0.3 ±0.03 mm	8 mm	15,000	---	50,000	---	---
0402	0.5 ±0.05 mm	8 mm	10,000	---	50,000	---	50,000
0603	0.8 ±0.1 mm	8 mm	4,000	---	15,000	---	15,000
0805	0.6 ±0.1 mm	8 mm	4,000	---	20,000	---	10,000
	0.8 / 0.85 ±0.1 mm	8 mm	4,000	---	15,000	---	8,000
	1.25 ±0.2 mm	8 mm	---	3,000	---	10,000	5,000
1206	0.6 ±0.1 mm	8 mm	4,000	---	20,000	---	---
	0.8 / 0.85 ±0.1 mm	8 mm	4,000	---	15,000	---	---
	1.00 / 1.15 ±0.1 mm	8 mm	---	3,000	---	10,000	---
	1.25 ±0.2 mm	8 mm	---	3,000	---	10,000	---
	1.6 ±0.15 mm	8 mm	---	2,500	---	10,000	---
	1.6 ±0.2 mm	8 mm	---	2,000	---	8,000	---
1210	0.6 / 0.7 ±0.1 mm	8 mm	---	4,000	---	15,000	---
	0.85 ±0.1 mm	8 mm	---	4,000	---	10,000	---
	1.15 ±0.1 mm	8 mm	---	3,000	---	10,000	---
	1.15 ±0.15 mm	8 mm	---	3,000	---	10,000	---
	1.25 ±0.2 mm	8 mm	---	3,000	---	---	---
	1.5 ±0.1 mm	8 mm	---	2,000	---	---	---
	1.6 / 1.9 ±0.2 mm	8 mm	---	2,000	---	---	---
	2.0 ±0.2 mm	8 mm	---	2,000 1,000	---	---	---
	2.5 ±0.2 mm	8 mm	---	1,000 500	---	---	---
1808	1.15 ±0.15 mm	12 mm	---	3,000	---	---	---
	1.25 ±0.2 mm	12 mm	---	3,000	---	---	---
	1.35 ±0.15 mm	12 mm	---	2,000	---	---	---
	1.5 ±0.1 mm	12 mm	---	2,000	---	---	---
	1.6 ±0.2 mm	12 mm	---	2,000	---	8,000	---
	2.0 ±0.2 mm	12 mm	---	2,000	---	---	---
	2.5 ±0.2 mm	12 mm	---	---	---	---	---
1812	0.6 / 0.85 ±0.1 mm	12 mm	---	2,000	---	---	---
	1.15 ±0.1 mm	12 mm	---	1,000	---	---	---
	1.15 ±0.15 mm	12 mm	---	1,000	---	---	---
	1.25 ±0.2 mm	12 mm	---	1,000	---	---	---
	1.35 ±0.15 mm	12 mm	---	1,000	---	---	---
	1.5 ±0.1 mm	12 mm	---	1,000	---	---	---
	1.6 ±0.2 mm	12 mm	---	1,000	---	---	---
	2.0 ±0.2 mm	12 mm	---	1,000	---	---	---
	2.5 ±0.2 mm	12 mm	---	500	---	---	---

ELECTRICAL CHARACTERISTICS

NP0/X7R DIELECTRIC CAPACITORS; NISN TERMINATIONS

Unless otherwise specified, all test and measurements shall be made under standard atmospheric conditions for testing as given in 5.3 of IEC 60068-1:

- Temperature: 15 °C to 35 °C
- Relative humidity: 25% to 75%
- Air pressure: 86 kPa to 106 kPa

Before the measurements are made, the capacitor shall be stored at the measuring temperature for a time sufficient to allow the entire capacitor to reach this temperature.

The period as prescribed for recovery at the end of a test is normally sufficient for this purpose.

Table 14

DESCRIPTION		VALUE
Capacitance range		0.47 pF to 2.2 μF
Capacitance tolerance		
NP0	C < 10 pF	±0.25 pF, ±0.5 pF
	C ≥ 10 pF	±2%, ±5%, ±10%
X7R		±5% ⁽¹⁾ , ±10%, ±20%
Dissipation factor (D.F.)		
NP0	C < 30 pF	≤ 1 / (400 + 20C)
	C ≥ 30 pF	≤ 0.1 %
X7R		≤ 2.5 %
Exception		
X7R/0603/100V, 12nF ≤ C ≤ 100nF, X7R/1206/2.2uF/100V		≤ 5%
X7R/1206/100V/1uF; X7R/1210/100V/1uF and 2.2uF;		≤ 3.5%
Insulation resistance after 1 minute at U _r (DC)		R _{ins} ≥ 10 GΩ or R _{ins} × C ≥ 500 seconds whichever is less
Maximum capacitance change as a function of temperature (temperature characteristic/coefficient):		
NP0		±30 ppm/°C
X7R		±15%
Operating temperature range:		
NP0/X7R		-55 °C to +125 °C

NOTE

1. Capacitance tolerance ±5% doesn't available for X7R full product range, please contact local sales force before order

SOLDERING RECOMMENDATION

Table 15

SOLDERING METHOD	SIZE					
	0201	0402	0603	0805	1206	≥ 1210
Reflow	Reflow only	> 100 nF	> 1.0 μF	> 2.2 μF	> 2.2 μF	Reflow only
Reflow/Wave		≤ 100 nF	≤ 1.0 μF	≤ 2.2 μF	≤ 2.2 μF	---

TESTS AND REQUIREMENTS

Table 16 Test procedures and requirements

TEST	TEST METHOD	PROCEDURE	REQUIREMENTS
Mounting	IEC 60384-21/22	4.3 The capacitors may be mounted on printed-circuit boards or ceramic substrates	No visible damage
Visual Inspection and Dimension Check		4.4 Any applicable method using × 10 magnification	In accordance with specification
Capacitance		4.5.1 Class 1: f = 1 MHz for C ≤ 1 nF, measuring at voltage V _{rms} at 20 °C f = 1 KHz for C > 1 nF, measuring at voltage V _{rms} at 20 °C Class 2: f = 1 KHz for C ≤ 10 μF, measuring at voltage V _{rms} at 20 °C	Within specified tolerance
Dissipation Factor (D.F.)		4.5.2 Class 1: f = 1 MHz for C ≤ 1 nF, measuring at voltage V _{rms} at 20 °C f = 1 KHz for C > 1 nF, measuring at voltage V _{rms} at 20 °C Class 2: f = 1 KHz for C ≤ 10 μF, measuring at voltage V _{rms} at 20 °C	In accordance with specification
Insulation Resistance		4.5.3 U _r ≤ 500 V: At U _r for 1 minute U _r > 500 V: At 500 V for 1 minute	In accordance with specification

TEST	TEST METHOD	PROCEDURE	REQUIREMENTS									
Temperature coefficient	4.6	Capacitance shall be measured by the steps shown in the following table. The capacitance change should be measured after 5 min at each specified temperature stage.	<General purpose series> Class I: $\Delta C/C: \pm 30\text{ppm}$ Class2: X7R: $\Delta C/C: \pm 15\%$ Y5V: $\Delta C/C: 22\sim-82\%$ <High Capacitance series> Class2: X7R/X5R: $\Delta C/C: \pm 15\%$ Y5V: $\Delta C/C: 22\sim-82\%$									
		<table border="1"> <thead> <tr> <th>Step</th> <th>Temperature(°C)</th> </tr> </thead> <tbody> <tr> <td>a</td> <td>25±2</td> </tr> <tr> <td>b</td> <td>Lower temperature±3°C</td> </tr> <tr> <td>c</td> <td>25±2</td> </tr> <tr> <td>d</td> <td>Upper Temperature±2°C</td> </tr> <tr> <td>e</td> <td>25±2</td> </tr> </tbody> </table> <p>(1) Class I Temperature Coefficient shall be calculated from the formula as below $\text{Temp. Coefficient} = \frac{C2 - C1}{C1 \times \Delta T} \times 10^6 \text{ [ppm/°C]}$ C1: Capacitance at step c C2: Capacitance at 125°C $\Delta T: 100^\circ\text{C}(=125^\circ\text{C}-25^\circ\text{C})$</p> <p>(2) Class II Capacitance Change shall be calculated from the formula as below $\Delta C = \frac{C2 - C1}{C1} \times 100\%$ C1: Capacitance at step c C2: Capacitance at step b or d</p>		Step	Temperature(°C)	a	25±2	b	Lower temperature±3°C	c	25±2	d
Step	Temperature(°C)											
a	25±2											
b	Lower temperature±3°C											
c	25±2											
d	Upper Temperature±2°C											
e	25±2											
Adhesion	IEC 60384-21/22	4.7 A force applied for 10 seconds to the line joining the terminations and in a plane parallel to the substrate	Force size ≥ 0603: 5N									
Bending Strength		4.8 Mounting in accordance with IEC 60384-22 paragraph 4.3 Conditions: bending 1 mm at a rate of 1 mm/s, radius jig 5 mm	No visible damage $\Delta C/C$ Class I: NP0: within ±1% or 0.5 pF, whichever is greater Class2: X7R: ±10%									

TEST	TEST METHOD	PROCEDURE	REQUIREMENTS
Resistance to Soldering Heat	4.9	<p>Precondition: 150 +0/-10 °C for 1 hour, then keep for 24 ±1 hours at room temperature</p> <p>Preheating: for size ≤ 1206: 120 °C to 150 °C for 1 minute</p> <p>Preheating: for size >1206: 100 °C to 120 °C for 1 minute and 170 °C to 200 °C for 1 minute</p> <p>Solder bath temperature: 260 ±5 °C</p> <p>Dipping time: 10 ±0.5 seconds</p> <p>Recovery time: 24 ±2 hours</p>	<p>Dissolution of the end face plating shall not exceed 25% of the length of the edge concerned</p> <hr/> <p>$\Delta C/C$</p> <p>Class I: NP0: within ±0.5% or 0.5 pF, whichever is greater</p> <p>Class2: X7R: ±10%</p> <hr/> <p>D.F. within initial specified value</p> <p>R_{ins} within initial specified value</p>
Solderability	4.10	<p>Preheated the temperature of 80 °C to 140 °C and maintained for 30 seconds to 60 seconds.</p> <p>1. Temperature: 235±5°C / Dipping time: 2 ±0.5 s</p> <p>2. Temperature: 245±5°C / Dipping time: 3 ±0.5 s (lead free)</p> <p>Depth of immersion: 10mm</p>	<p>The solder should cover over 95% of the critical area of each termination</p>
Rapid Change of Temperature	IEC 60384-21/22 4.11	<p>Preconditioning; 150 +0/-10 °C for 1 hour, then keep for 24 ±1 hours at room temperature</p> <p>5 cycles with following detail: 30 minutes at lower category temperature 30 minutes at upper category temperature</p> <p>Recovery time 24 ±2 hours</p>	<p>No visual damage</p> <hr/> <p>$\Delta C/C$</p> <p>Class I: NP0: within ±1% or 1 pF, whichever is greater</p> <p>Class2: X7R: ±15%</p> <hr/> <p>D.F. meet initial specified value</p> <p>R_{ins} meet initial specified value</p>

TEST	TEST METHOD	PROCEDURE	REQUIREMENTS															
Damp Heat	4.13	<p>3. Preconditioning, class 2 only: 150 +0/-10 °C /1 hour, then keep for 24 ±1 hour at room temp</p> <p>4. Initial measure: Spec: refer initial spec C, D, IR</p> <p>5. Damp heat test: 500 ±12 hours at 40 ±2 °C; 90 to 95% R.H.</p> <p>6. Recovery: Class 1: 6 to 24 hours Class 2: 24 ±2 hours</p> <p>7. Final measure: C, D, IR</p> <p>P.S. If the capacitance value is less than the minimum value permitted, then after the other measurements have been made the capacitor shall be precondition according to "IEC 60384 4.1" and then the requirement shall be met.</p>	<p>No visual damage after recovery</p> <hr/> <p>$\Delta C/C$ Class 1: NP0: within ±2% or 1 pF, whichever is greater Class2: X7R: ±15% D.F. Class 1: NP0: ≤ 2 x specified value Class2: X7R: ≥ 25 V: ≤ 5% R_{ins} Class 1: NP0: ≥ 2,500 MΩ or $R_{ins} \times C_r \geq 25s$ whichever is less Class2: X7R: ≥ 500 MΩ or $R_{ins} \times C_r \geq 25s$ whichever is less</p>															
Endurance	IEC 60384-21/22 4.14	<p>1. Preconditioning, class 2 only: 150 +0/-10 °C /1 hour, then keep for 24 ±1 hour at room temp</p> <p>2. Initial measure: Spec: refer initial spec C, D, IR</p> <p>3. Endurance test: Temperature: NP0/X7R: 125 °C Specified stress voltage applied for 1,000 hours:</p> <p>4. High voltage series follows with below stress condition:</p> <table border="1" style="margin-left: 20px;"> <thead> <tr> <th>Voltage</th> <th>NP0</th> <th>X7R</th> </tr> </thead> <tbody> <tr> <td>≤ 100V</td> <td>2.0 × Ur</td> <td>2.0 × Ur</td> </tr> <tr> <td>200/250V</td> <td>1.5 × Ur</td> <td>1.5 × Ur</td> </tr> <tr> <td>500/630V</td> <td>1.3 × Ur</td> <td>1.2 × Ur</td> </tr> <tr> <td>≥ 1KV</td> <td>1.2 × Ur</td> <td>1.1 × Ur</td> </tr> </tbody> </table> <p>5. Recovery time: 24 ±2 hours</p> <p>6. Final measure: C, D, IR</p> <p>P.S. If the capacitance value is less than the minimum value permitted, then after the other measurements have been made the capacitor shall be precondition according to "IEC 60384 4.1" and then the requirement shall be met.</p>	Voltage	NP0	X7R	≤ 100V	2.0 × Ur	2.0 × Ur	200/250V	1.5 × Ur	1.5 × Ur	500/630V	1.3 × Ur	1.2 × Ur	≥ 1KV	1.2 × Ur	1.1 × Ur	<p>No visual damage</p> <hr/> <p>$\Delta C/C$ Class 1: NP0: within ±2% or 1 pF, whichever is greater Class2: X7R: ±15% D.F. Class 1: NP0: ≤ 2 x specified value Class2: X7R: ≥ 25 V: ≤ 5% R_{ins} Class 1: NP0: ≥ 4,000 MΩ or $R_{ins} \times C_r \geq 40s$ whichever is less Class2: X7R: ≥ 1,000 MΩ or $R_{ins} \times C_r \geq 50s$ whichever is less</p>
Voltage	NP0	X7R																
≤ 100V	2.0 × Ur	2.0 × Ur																
200/250V	1.5 × Ur	1.5 × Ur																
500/630V	1.3 × Ur	1.2 × Ur																
≥ 1KV	1.2 × Ur	1.1 × Ur																
Voltage Proof	4.6	<p>Specified stress voltage applied for 1~5 seconds</p> <p>Ur ≤ 100 V: series applied 2.5 Ur 100 V < Ur ≤ 200 V series applied (1.5 Ur + 100) 200 V < Ur ≤ 500 V series applied (1.3 Ur + 100) Ur > 500 V: 1.3 Ur Ur ≥ 1000 V: 1.2 Ur Charge/Discharge current is less than 50 mA</p>	<p>No breakdown or flashover</p>															

REVISION HISTORY

REVISION	DATE	CHANGE NOTIFICATION	DESCRIPTION
Version 21	Jul. 13, 2018	-	- Add NP0/0402/120pF to 1nF/100V, NP0/0603/1.2nF to 1.5nF/100V, NP0/1206/1.8nF/630V, NP0/1210/12nF to 22nF/100V - Add X7R/0805/33nF to 47nF/200 to 250V
Version 20	Sep. 14, 2017	-	- Dimension outlines updated
Version 19	Mar 7, 2017	-	- 0805 L4 spec updated
Version 18	Dec 9, 2016	-	- Soldering recommendation update
Version 17	Aug 16, 2016	-	- Capacitance range & thickness update
Version 16	Apr. 16, 2015	-	- Capacitance range & thickness
Version 15	Apr. 16, 2015	-	- Electrical characteristics update
Version 14	Sep. 25, 2014	-	- Electrical characteristics update
Version 13	Apr. 21, 2014	-	- Electrical characteristics update
Version 12	Dec. 12, 2013	-	- Electrical characteristics update
Version 11	Jun. 17, 2013	-	- Test method and procedure updated
Version 10	Nov 22, 2012	-	- Test method and procedure updated
Version 9	Feb 02, 2012	-	- Test method and procedure updated
Version 8	Apr 22, 2011	-	- NP0 0402 100V added
Version 7	Mar 01, 2011	-	- Dimension updated
Version 6	Sep 30, 2010	-	- Update the thickness of 0805 100V
Version 5	Sep 28, 2010	-	- Product range updated - Thickness classes and packing quantity table updated
Version 4	Jun 17, 2010	-	- Update the dimension of 0805, 1206 and 1812
Version 3	Mar 25, 2010	-	- Product range update
Version 2	Mar 15, 2010	-	- Product range update
Version 1	Oct 30, 2009	-	- Change to dual brand datasheet that describe Mid-voltage NP0/X7R series with RoHS compliant - Replace the "100V to 630V" part of pdf files: UP-NP0X7R_MV_100-to-500V_0, UY-NP0X7R_MV_100-to-500V_0, NP0_16V-to-100V_6, NP0_50-to-500V_10, X7R_16-to-500V_9 and X7R_16V-to-100V_9 - Define global part number - Description of "Halogen Free compliant" added - Test method and procedure updated
Version 0	Sep 08, 2005	-	- New