

AirMatrix® Surface Mount Fuses

AF Series, 2410 Size



Features:

- Fast acting at 200% overload current level
- Excellent inrush current withstanding capability
- Fiberglass enforced epoxy fuse body
- Copper or copper alloy composite fuse link
- Copper termination with nickel and tin plating
- Halogen free, RoHS compliant and 100% lead-free
- Operating temperature range: -55°C to +125°C (with de-rating)

Application Fields:

- Power Supply, e.g. DC/DC converters, DC/AC inverters, Backlight drivers , etc.
- Consumer Electronics, e.g. LCD TVs, PDP, DVDs, PCM , etc.
- Communication Technology, e.g. Telecom systems, Networking, Modems, Routers, Changers, Base stations , etc.
- Office Automation Electronics
- IT Products, e.g. LCD monitors, Notebooks, PC servers, etc.

Shape and Dimensions:

Unit	Inch	mm
L	0.240 ± 0.006	6.10 ± 0.15
W	0.098 ± 0.006	2.49 ± 0.15
T	0.085 ± 0.008	2.16 ± 0.20
B	0.053 ± 0.015	1.35 ± 0.38

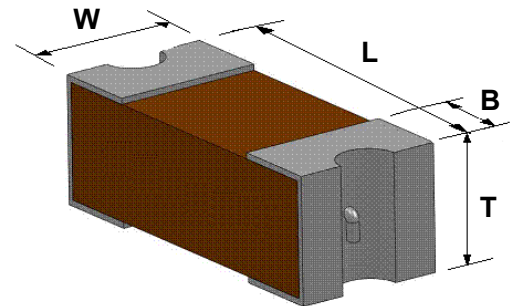

Clearing Time Characteristics:

% of Current Rating	Clearing Time at 25°C	
100%	4 hours min.	
200%(0.50~10.0 A)	0.01 seconds min.	5 seconds max.
200%(12.0~20.0 A)	0.01 seconds min.	20 seconds max.

Agency Approval:

- Recognized Under the Components Program of Underwriters Laboratories. File Number: E232989
- PSE Certificate No: NBK180711-JP13710
- TUV File Number: 50209083
- CQC No.: CQC11012065955

Patents:

Patent numbers "ZL200810092353.3", "ZL200910007157.6", "ZL201120450579.3", "ZL201120536307.5", "ZL201220063222.4", "ZL201110123326.X".

AirMatrix[®] Surface Mount Fuses

AF Series, 2410 Size

Ordering Information:

Part Number	Current Rating (A)	Voltage Rating (V)		Interrupting Rating	Nominal Cold DCR (Ω) ¹	Nominal I^2t (A^2s) ²	Agency Approval				Marking (Optional) ³
		AC	DC				UL	PSE	TUV	CQC	
AF2-0.50V125TM	0.5	250		TUV: 0.5 ~ 2 A 100 A @ 250 VAC 50 A @ 125 VDC	0.231	0.10	✓		✓	✓	C
AF2-0.63V125TM	0.63				0.174	0.16	✓		✓		S
AF2-0.75V125TM	0.75				0.148	0.23	✓				D
AF2-1.00V125TM	1.0				0.093	0.59	✓	✓	✓	✓	E
AF2-1.25V125TM	1.25				0.07	0.96	✓	✓	✓		F
AF2-1.50V125TM	1.5				0.062	1.19	✓	✓			G
AF2-2.00V125TM	2.0				0.042	2.75	✓	✓	✓	✓	I
AF2-2.50V125TM	2.5				0.031	1.21	✓	✓			J
AF2-3.00V125TM	3.0				0.0249	1.73	✓	✓			K
AF2-3.15V125TM	3.15				0.0232	2.2	✓	✓			V
AF2-3.50V125TM	3.5	125		UL: 0.5 ~ 2 A 100A @ 250VAC 1.5 ~ 8 A 50A @ 125VAC 0.5 ~ 8 A 50 A @ 125 VDC 300 A @ 32 VDC	0.022	2.5	✓	✓			L
AF2-4.00V125TM	4.0				0.0172	4.1	✓	✓			M
AF2-5.00V125TM	5.0				0.0143	5.9	✓	✓			N
AF2-6.30V125TM	6.3				0.01	12.5	✓				O
AF2-7.00V125TM	7.0				0.0094	14.2	✓				P
AF2-8.00V125TM	8.0				0.0086	20.3	✓				R
AF2-10.0V125TM	10.0				0.0066	29.2	✓				Q
AF2-12.0V065TM	12.0				65	65	50 A @ 65 VAC 50 A @ 65 VDC 300 A @ 32 VDC	0.0053	49.2	✓	
AF2-15.0V065TM	15.0	0.0038	102.5	✓							Y
AF2-20.0V065TM	20.0	0.0034	126.2	✓							Z

1. Measured at $\leq 10\%$ rated current and 25°C ambient.
 2. Melting I^2t at 0.001 second pre-arcing time.
 3. White Marking Character Code.

AirMatrix[®] Surface Mount Fuses

AF Series, 2410 Size

Average Pre-arcing Time Curves:

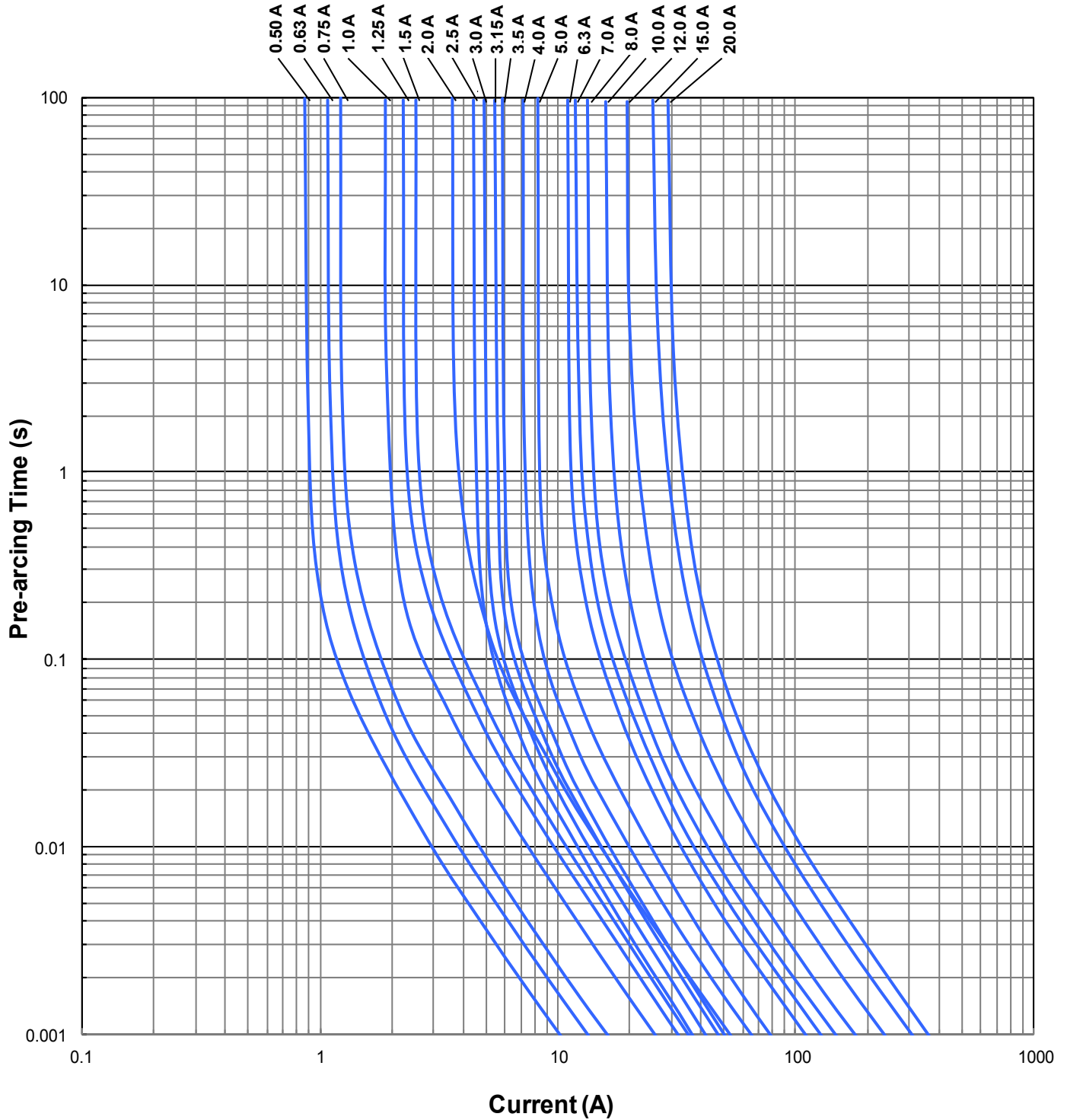

AirMatrix[®] Surface Mount Fuses

AF Series, 2410 Size

Average I^2t vs. t Curves:

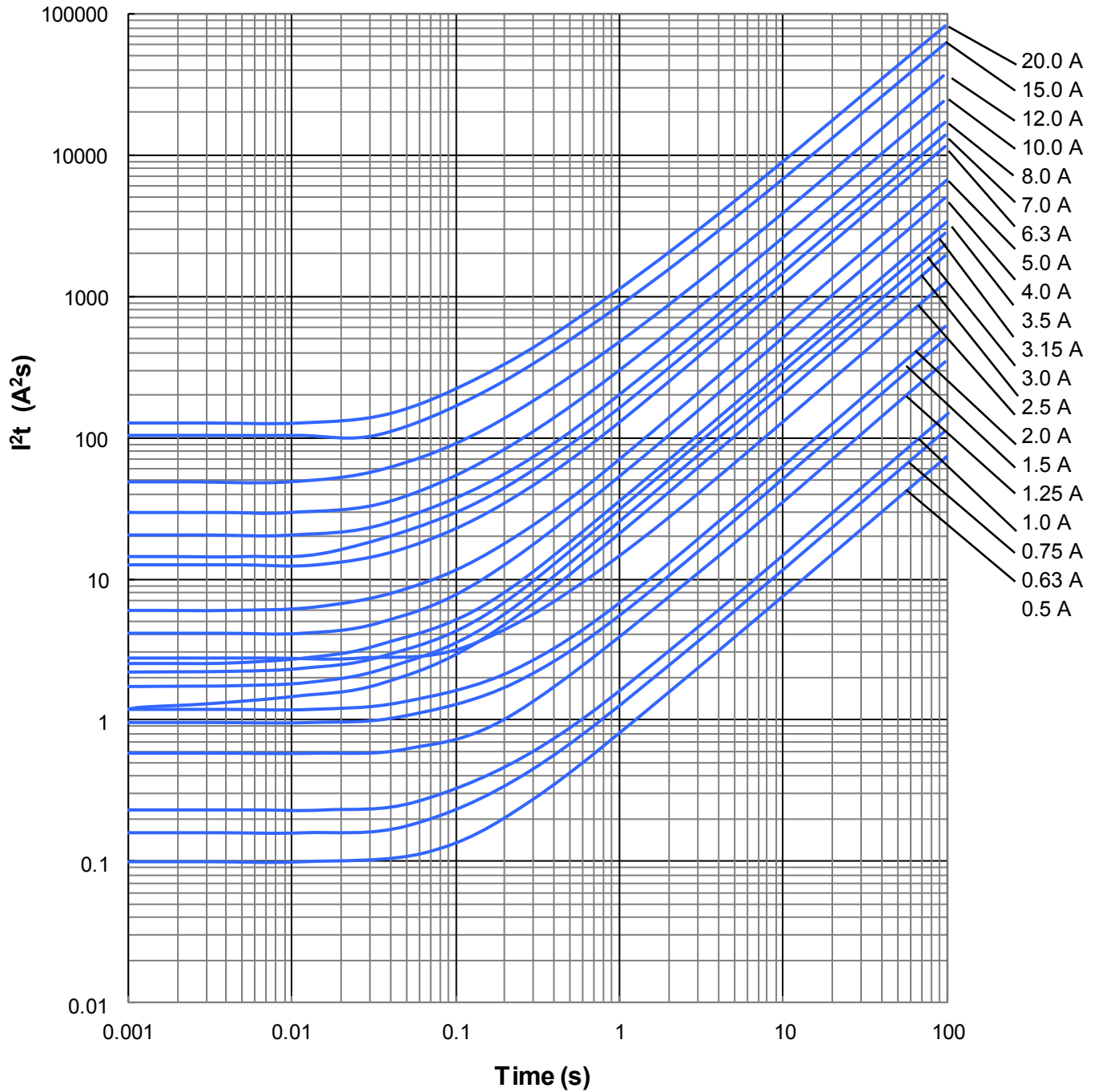

AirMatrix® Surface Mount Fuses

Product Identification:

AF2 1.00 V125 T M

(1) (2) (3) (4) (5)

- (1) **Series Code:** AF2
- (2) **Current Rating Code:** 1.00—1.00A
- (3) **Voltage Rating Code:** V125—125VDC
- (4) **Package Code:** T - Tape & Reel, B - Bulk
- (5) **Marking Code:** M - With Marking

AF 1206 F 2.00 T M

(1) (2) (3) (4) (5) (6)

- (1) **Series Code:** AF—AF Series, MF—MF Series
- (2) **Size Code:** Standard EIA Chip Sizes
- (3) **Time/Current Characteristic:** F
- (4) **Current Rating:** 2.00—2.00A
- (5) **Package Code:** T - Tape & Reel, B - Bulk
- (6) **Marking Code:** M - With Marking

Recommended Land Pattern:

	AF2		AF1206		MF2410		MF1210	
	Inch	mm	Inch	mm	Inch	mm	Inch	mm
L	0.338	8.60	0.173	4.40	0.338	8.60	0.170	4.40
G	0.118	3.00	0.059	1.50	0.118	3.00	0.070	1.70
H	0.124	3.15	0.071	1.80	0.110	2.80	0.110	2.70

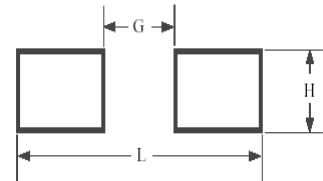

Packaging:

Chip Size	Parts on 7 inch (178 mm) Reel
2410 (6125)	2,000
1210 (3225)	2,500
1206 (3216)	3,500

Storage:

The maximum ambient temperature shall not exceed 35°C . Storage temperatures higher than 35°C could result in the deformation of packaging materials.

The maximum relative humidity recommended for storage is 75%. High humidity with high temperature can accelerate the oxidation of the solder plating on the termination and reduce the solderability of the components.

Sealed vacuum foil bags with desiccant should only be opened prior to use.

AirMatrix[®] Surface Mount Fuses

Fuse Selection and Temperature De-rating Guideline:

The ambient temperature affects the current carrying capacity of fuses. When a fuse is operating at a temperature higher than 25°C, the fuse shall be “de-rated”.

To select a fuse from the catalog, the following rule may be followed:

Catalog Fuse Current Rating = Nominal Operating Current / 0.75 / % De-rating at the maximum operating temperature.

Example: At maximum operating temperature of 65°C, % De-rating is 90%. The nominal operating current is 4 A. The current rating for fuse selected from the catalog shall be:

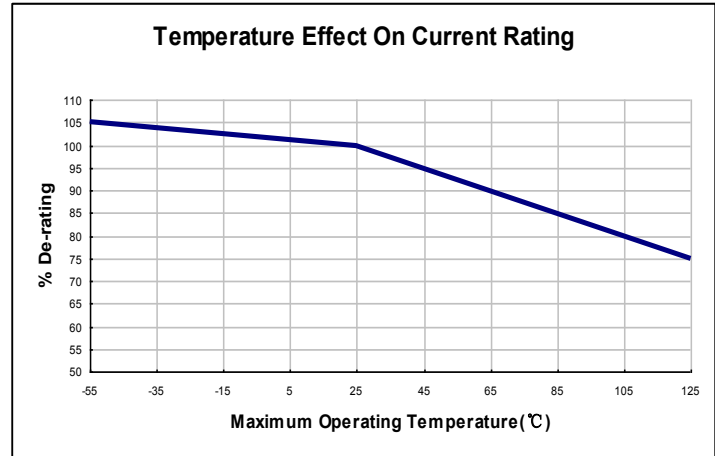

Environmental Tests:

Reliability Test	Test Condition and Requirement	Test Reference
Reflow & Bend	3 reflows at 245°C followed by a 2 mm bend, 20% DCR change max. (10% for ≤ 1 A), no mechanical damage	Refer to AEM QIQ034 ,QIQ048
Solderability	245°C, 5 seconds, new solder coverage 90% minimum	MIL-STD-202 Method 208
Soldering Heat Resistance	260°C, 10 seconds, 20% DCR change max. (10% for ≤ 1 A), new solder coverage 75% minimum	MIL-STD-202 Method 210
Life	25°C, 2000 hours, 80% rated current (75% for < 1 A), voltage drop change ≤ ±20%	Refer to AEM QIQ106
Thermal Shock	-65°C to +125°C, 100 cycles, 10% DCR change max., no mechanical damage	MIL-STD-202 Method 107
Mechanical Vibration	5 – 3000 Hz, 0.4 inch double amplitude or 30 G peak, 10% DCR change max., no mechanical damage	MIL-STD-202 Method 204
Mechanical Shock	1500 G, 0.5 milliseconds, half-sine shocks, 10% DCR change max., no mechanical damage	MIL-STD-202 Method 213
Salt Spray	5% salt solution, 48 hour exposure, 10% DCR change max., no excessive corrosion	MIL-STD-202 Method 101
Moisture Resistance	10 cycles, 15% DCR change max., no excessive corrosion	MIL-STD-202 Method 106

AirMatrix[®] Surface Mount Fuses

Soldering Temperature Profile:

* Recommended Temperature Profile for Reflow Soldering

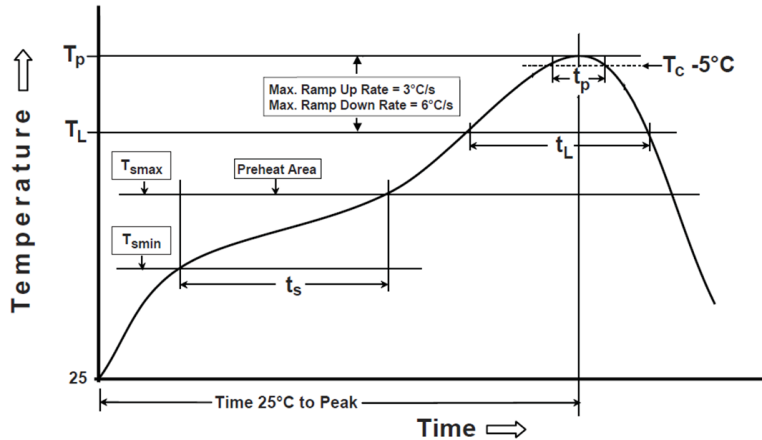

Profile Feature	Pb-Free Assembly
Preheat/Soak Temperature Min (T_{smin}) Temperature Max (T_{smax}) Time (t_s) from (T_{smin} to T_{smax})	150°C 200°C 60~120 seconds
Ramp-up rate (T_L to T_p)	3°C/second max.
Liquidous temperature (T_L) Time (t_L) maintained above T_L	217°C 60~150 seconds
Peak package body temperature (T_p)	260°C
Time (t_p)* within $5^\circ C$ of the specified classification temperature (T_c)	30 seconds *
Ramp-down rate (T_p to T_L)	6°C/second max.
Time 25°C to peak temperature	8 minutes max.
* Tolerance for peak profile temperature (T_p) is defined as a supplier minimum and a user maximum	

* Recommended Temperature Profile for Wave Soldering

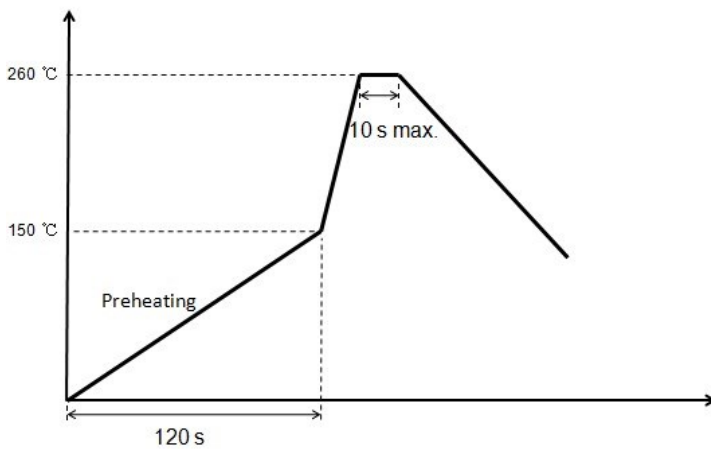

Disclaimer

Specifications are subject to change without notice. AEM products are designed for specific applications and should not be used for any purpose (including, without limitation, automotive, aerospace, medical, life-saving applications, or any other application which requires especially high reliability for the prevention of such defect as may directly cause damage to the third party's life, body or property) not expressly set forth in applicable AEM product documentation. It is the customer's responsibility to validate that a particular product with the properties described in the product specification is suitable for use in a particular application. Warranties granted by AEM shall be deemed void for products used for any purpose not expressly set forth in applicable AEM product documentation. AEM shall not be liable for any claims or damages arising out of products used in applications not expressly intended by AEM as set forth in applicable AEM product documentation. The sale and use of AEM products is subject to AEM terms and conditions of sale. Please refer