

SPECIFICATIONS

Customer	
Product Name	Multi-layer Chip Ceramic Inductor
Sunlord Part Number	SDCL1005 Series
Customer Part Number	

New Released, Revised]

SPEC No.: [SDCL02140000](#)

【This SPEC is total 9 pages including specifications and appendix.】

【ROHS Compliant Parts】

Approved By	Checked By	Issued By

Shenzhen Sunlord Electronics Co., Ltd.

Address: Sunlord Industrial Park, Dafuyuan Industrial Zone, Baoan, Shenzhen, China 518110
Tel: 0086-755-29832660 Fax: 0086-755-82269029 E-Mail: sunlord@sunlordinc.com

【For Customer approval Only】

Date: _____

Qualification Status: Full Restricted Rejected

Approved By	Verified By	Re-checked By	Checked By

Comments:

【Version change history】

Rev.	Effective Date	Changed Contents	Change Reasons	Approved By
01	/	New release	/	Hai Guo

1. Scope

This specification applies to SDCL1005 series of multi-layer ceramic chip inductor.

2. Product Description and Identification (Part Number)

- 1) Description
SDCL1005 series of multi-layer ceramic chip inductor.
- 2) Product Identification (Part Number)

SDCL ※※※※ C XXX □ ◎ D F
 ① ② ③ ④ ⑤ ⑥ ⑦ ⑧

①	Type
SDCL	Chip Ceramic Inductor

②	External Dimensions (L X W) (mm)
1005 [0402]	1.0 X 0.5

③	Material Code
	C

④	Nominal Inductance
Example	Nominal Value
3N9	3.9nH
10N	10nH
R10	100nH

⑤	Inductance Tolerance
C	±0.2nH
S	±0.3nH
H	±3%
J	±5%
K	±10%

⑥	Packing
T	Tape Carrier Package

⑦	Internal Code
	D

⑧	HSF Products
	Hazardous Substance Free Products

3. Electrical Characteristics

Please refer to **Appendix A** (Page 9).

- 1) Operating and storage temperature range (individual chip without packing): -55°C~ +125°C
- 2) Storage temperature range (packaging conditions): -10°C~+40°C and RH 70% (Max.)

4. Shape and Dimensions

- 1) Dimensions and recommended PCB pattern for reflow soldering: See **Fig.4-1**, **Fig.4-2** and **Table 4-1**.
- 2) Structure: See **Fig. 4-3** and **Fig. 4-4**.

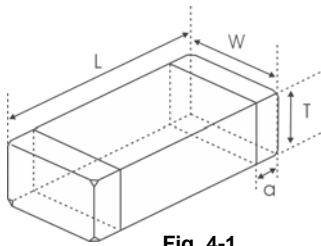

Fig. 4-1

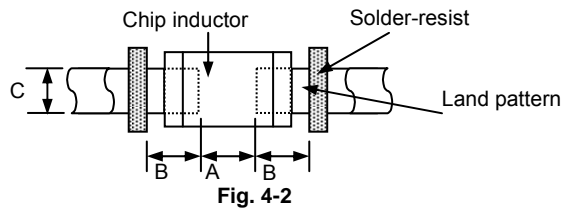

Fig. 4-2

[Table 4-1]

Unit: mm [inch]

Type	L	W	T	a	A	B	C
1005 [0402]	1.0±0.15 [0.039±0.006]	0.5±0.15 [0.020±0.006]	0.5±0.15 [0.020±0.006]	0.25±0.1 [0.010±0.004]	0.45~0.55	0.40~0.50	0.45~0.55

Note: The details of different length for different products see **Appendix A**: Electrical Characteristics.

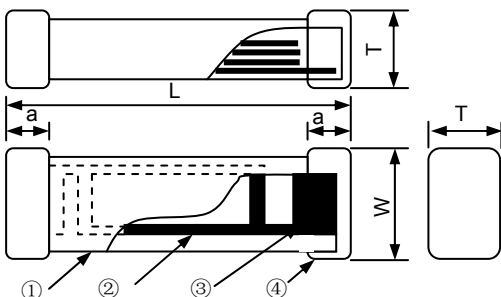

Fig. 4-3

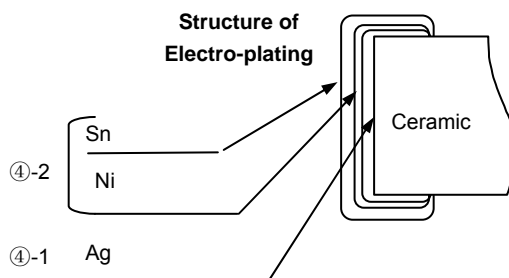

Fig. 4-4

- ① Ceramic for SDCL Series
- ② Internal electrode (Ag)
- ③ Pull out electrode (Ag)
- ④-1 Terminal electrode: Inside (Ag)
- ④-2 Outside (Electro-plating Ni-Sn)

- 3) Material Information: See **Table 4-2**

[Table 4-2]

Code	Part Name	Material Name
①	Ceramic Body	Ceramic Powder
②	Inner Coils	Silver Paste
③	Pull-out Electrode (Ag)	Silver Paste
④-1	Terminal Electrode: Inside Ag	Termination Silver Composition
④-2	Electro-Plating: Ni/Sn plating	Plating Chemicals

- 4) The surface with the mark should be on the top side when soldering, but it is not necessary to identify the mark's direction towards left or right.

5. Test and Measurement Procedures

5.1 Test Conditions

Unless otherwise specified, the standard atmospheric conditions for measurement/test as:

- Ambient Temperature: $20 \pm 15^\circ\text{C}$
- Relative Humidity: $65 \pm 20\%$
- Air Pressure: 86kPa to 106kPa

If any doubt on the results, measurements/tests should be made within the following limits:

- Ambient Temperature: $20 \pm 2^\circ\text{C}$
- Relative Humidity: $65 \pm 5\%$
- Air Pressure: 86kPa to 106kPa

5.2 Visual Examination

- Inspection Equipment: 20× magnifier

5.3 Electrical Test

5.3.1 DC Resistance (DCR)

- Refer to **Appendix A**.
- Test equipment (Analyzer): High Accuracy Milliohmmeter-HP4338B or equivalent.

5.3.2 Inductance (L)

- Refer to **Appendix A**.
- Test equipment: High Accuracy RF Impedance /Material Analyzer-E4991A+HP16192A,
- Test signal: -20dBm or 50mV
- Test frequency refers to Appendix A.

5.3.3 Q Factor (Q)

- Refer to **Appendix A**.
- Test equipment: High Accuracy RF Impedance /Material Analyzer-E4991A+HP16192A
- Test signal: -20dBm or 50mV
- Test frequency refers to Appendix A.

5.3.4 Self-Resonant Frequency (SRF)

- Refer to **Appendix A**.
- Test equipment: High Accuracy RF Impedance /Material Analyzer- E4991A+HP16192A or Agilent E5071C Network analyzer(when $\text{SRF} > 3\text{GHz}$).
- Test signal: -20dBm or 50 mV

5.3.5 Rated Current

- Refer to **Appendix A**.
- Test equipment (see **Fig. 5.3.5-1**): Electric Power, Electric current meter, Thermometer.
- Measurement method (see **Fig. 5.3.5-1**):
 - Set test current to be 0mA.
 - Measure initial temperature of chip surface.
 - Gradually increase voltage and measure chip temperature for corresponding current.
- Definition of Rated Current(I_r): I_r is direct electric current as chip surface temperature rose just 20°C against chip initial surface temperature(T_a) (see **Fig. 5.3.5-2**).

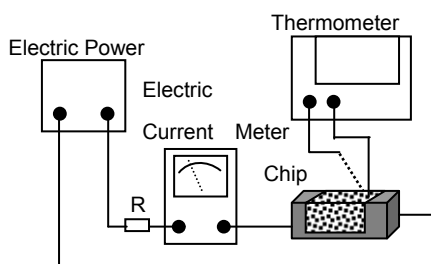

Fig. 5.3.5-1

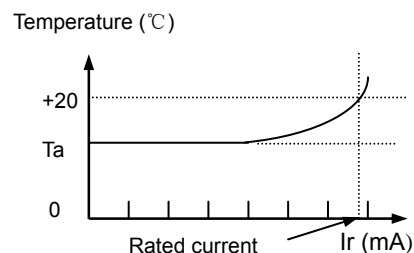
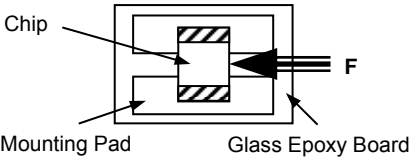
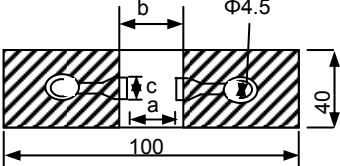
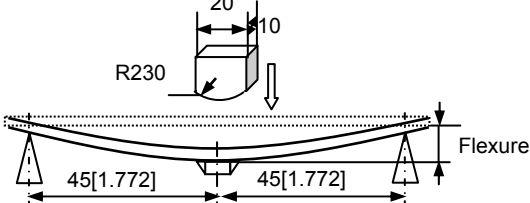
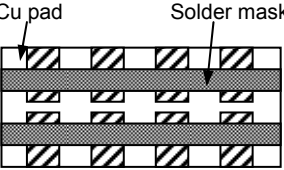
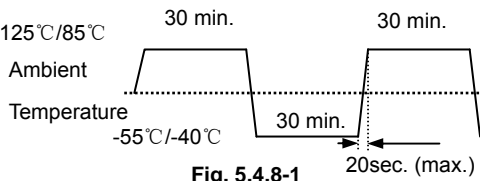

Fig. 5.3.5-2

5.4 Reliability Test

Items	Requirements	Test Methods and Remarks								
5.4.1 Terminal Strength	No removal or split of the termination or other defects shall occur.  <p style="text-align: center;">Fig.5.4.1-1</p>	① Solder the inductor to the testing jig (glass epoxy board shown in Fig. 5.4.1-1) using leadfree solder. Then apply a force in the direction of the arrow. ② 5N force for SDCL1005 series. ③ Keep time: 10±1s ④ Speed: 1.0mm/s.								
5.4.2 Resistance to Flexure	No visible mechanical damage. <table border="1" data-bbox="325 555 756 640"> <thead> <tr> <th>Type</th> <th>a</th> <th colspan="2">Unit: mm [inch]</th> </tr> </thead> <tbody> <tr> <td>1005[0402]</td> <td>0.4</td> <td>1.5</td> <td>0.5</td> </tr> </tbody> </table>  <p style="text-align: center;">Fig. 5.4.2-1</p>	Type	a	Unit: mm [inch]		1005[0402]	0.4	1.5	0.5	① Solder the inductor to the test jig (glass epoxy board shown in Fig. 5.4.2-1) Using a leadfree solder. Then apply a force in the direction shown Fig. 5.4.2-2 . ② Flexure: 2mm. ③ Pressurizing Speed: 0.5mm/sec. ④ Keep time: 30 sec.  <p style="text-align: center;">Fig. 5.4.2-2</p>
Type	a	Unit: mm [inch]								
1005[0402]	0.4	1.5	0.5							
5.4.3 Vibration	① No visible mechanical damage. ② Inductance change: Within ±10%. ③ Q factor change: Within ±20%.  <p style="text-align: center;">Glass Epoxy Fig. 5.4.3-1</p>	① Solder the inductor to the testing jig (glass epoxy board shown in Fig. 5.4.3-1) using leadfree solder. ② The inductor shall be subjected to a simple harmonic motion having total amplitude of 1.5mm, the frequency being varied uniformly between the approximate limits of 10 and 55 Hz. ③ The frequency range from 10 to 55 Hz and return to 10 Hz shall be traversed in approximately 1 minute. This motion shall be applied for a period of 2 hours in each 3 mutually perpendicular directions (total of 6 hours).								
5.4.4 Dropping	① No visible mechanical damage. ② Inductance change: Within ±10%. ③ Q factor change: Within ±20%.	Drop chip inductor 10 times on a concrete floor from a height of 100 cm.								
5.4.5 Temperature	Inductance change should be within ±10% of initial value measuring at 20°C.	Temperature range: SDCL1005: -55°C to +125°C, Reference temperature: 20°C								
5.4.6 Solderability	① No visible mechanical damage. ② Wetting shall exceed 95% coverage.	① Solder temperature: 240±2°C ② Duration: 3 sec. ③ Solder: Sn/3.0Ag/0.5Cu. ④ Flux: 25% Resin and 75% ethanol in weight.								
5.4.7 Resistance to Soldering Heat	① No visible mechanical damage. ② Wetting shall exceed 95% coverage. . ③ Inductance change: Within ±10%. ④ Q factor change: Within ±20%.	① Solder temperature: 260±3°C ② Duration: 5 sec. ③ Solder: Sn/3.0Ag/0.5Cu. ④ Flux: 25% Resin and 75% ethanol in weight. ⑤ The chip shall be stabilized at normal condition for 1~2 hours before measuring.								
5.4.8 Thermal Shock	① No mechanical damage. ② Inductance change: Within ±10%. ③ Q factor change: Within ±20%.  <p style="text-align: center;">Fig. 5.4.8-1</p>	① Temperature, Time: (See Fig. 5.4.8-1) -55°C for 30±3 min → 125°C for 30±3 min, ② Transforming interval: Max. 20 sec. ③ Tested cycle: 100 cycles. ④ The chip shall be stabilized at normal condition for 1~2 hours before measuring.								

5.4.9 Resistance to Low Temperature	① No mechanical damage. ② Inductance change: Within $\pm 10\%$. ③ Q factor change: Within $\pm 20\%$.	① Temperature: $-55\pm 2^{\circ}\text{C}$, ② Duration: 1000^{+24} hours. ③ The chip shall be stabilized at normal condition for 1~2 hours before measuring.
5.4.10 Resistance to High Temperature	① No mechanical damage. ② Inductance change: Within $\pm 10\%$. ③ Q factor change: Within $\pm 20\%$.	① Temperature: $125\pm 2^{\circ}\text{C}$, ② Duration: 1000^{+24} hours. ③ The chip shall be stabilized at normal condition for 1~2 hours before measuring.
5.4.11 Damp Heat (Steady States)	① No visible mechanical damage. ② Inductance change: Within $\pm 10\%$. ③ Q factor change: Within $\pm 20\%$.	① Temperature: $60\pm 2^{\circ}\text{C}$ ② Humidity: 90% to 95% RH. ③ Duration: 1000^{+24} hours. ④ The chip shall be stabilized at normal condition for 1~2 hours before measuring.
5.4.12 Loading Under Damp Heat	① No visible mechanical damage. ② Inductance change: Within $\pm 10\%$. ③ Q factor change: Within $\pm 20\%$.	① Temperature: $60\pm 2^{\circ}\text{C}$ ② Humidity: 90% to 95% RH. ③ Duration: 1000^{+24} hours. ④ Applied current: Rated current. ⑤ The chip shall be stabilized at normal condition for 1~2 hours before measuring.
5.4.13 Loading at High Temperature (Life Test)	① No visible mechanical damage. ② Inductance change: Within $\pm 10\%$. ③ Q factor change: Within $\pm 20\%$.	① Temperature $125\pm 2^{\circ}\text{C}$, ② Duration: 1000^{+24} hours. ③ Applied current: Rated current. ④ The chip shall be stabilized at normal condition for 1~2 hours before measuring.

6. Packaging, Storage

6.1 Packaging

Tape Carrier Packaging:

Packaging code: T

- a. Tape carrier packaging are specified in attached figure Fig.6.1-1~3
- b. Tape carrier packaging quantity please see the following table:

Type	1005[0402]
T(mm)	0.5 ± 0.15
Tape	Paper Tape
Quantity	10K

(1) Taping Drawings (Unit: mm)

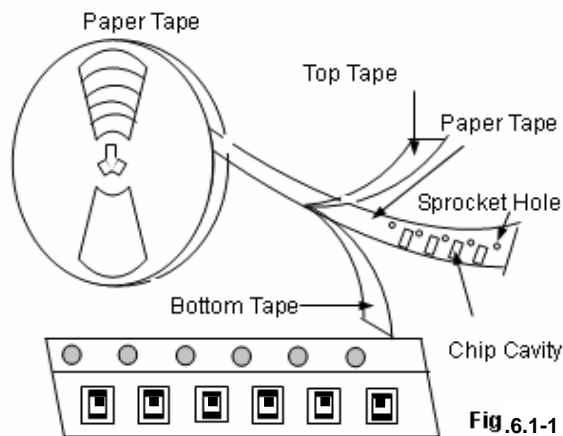

Remark: The sprocket holes are to the right as the tape is pulled toward the user.

(2) Taping Dimensions (Unit: mm)

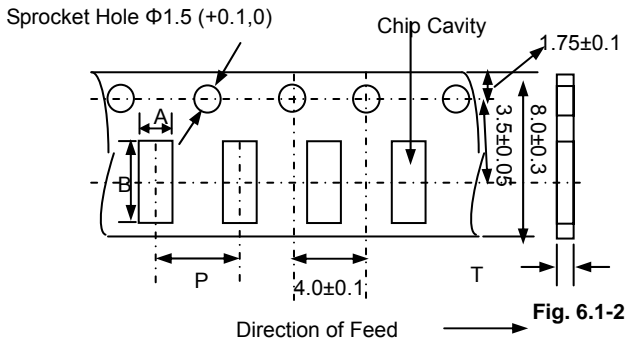

Paper Tape

Type	A	B	P	T max
1005[0402]	0.65 ± 0.1	1.15 ± 0.1	2.0 ± 0.05	0.8

(3) Reel Dimensions (Unit: mm)

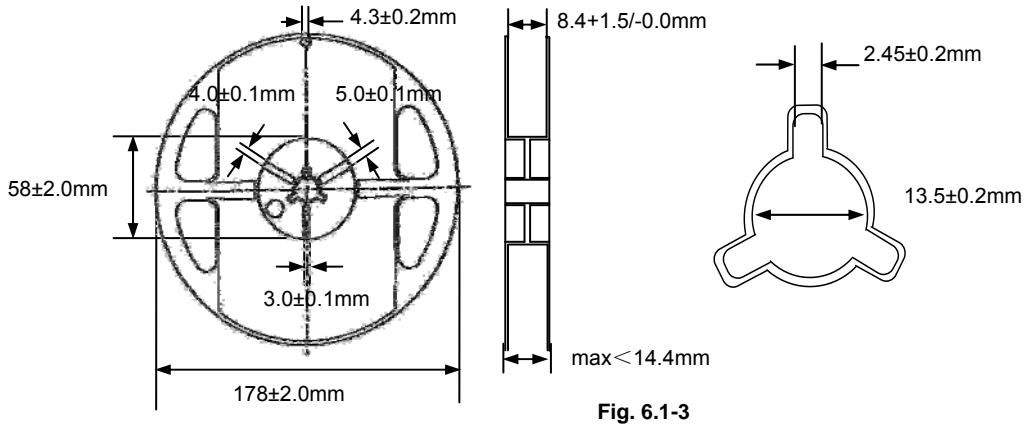

6.2 Storage

- a. The solderability of the external electrode may be deteriorated if packages are stored where they are exposed to high humidity. Package must be stored at 40°C or less and 70% RH or less.
- b. The solderability of the external electrode may be deteriorated if packages are stored where they are exposed to dust of harmful gas (e.g. HCl, sulfurous gas of H_2S).
- c. Packaging material may be deformed if package are stored where they are exposed to heat of direct sunlight.
- d. Solderability specified in **Clause 5.4.6** shall be guaranteed for 12 months from the date of delivery on condition that they are stored at the environment specified in **Clause 3**. For those parts, which passed more than 12 months shall be checked solder-ability before use.

7. Recommended Soldering Technologies

7.1 Re-flowing Profile:

- △ Preheat condition: $150 \sim 200^\circ\text{C} / 60 \sim 120$ sec.
- △ Allowed time above 217°C : $60 \sim 90$ sec.
- △ Max temp: 260°C
- △ Max time at max temp: 10sec.
- △ Solder paste: Sn/3.0Ag/0.5Cu
- △ Allowed Reflow time: 2x max

[Note: The reflow profile in the above table is only for qualification and is not meant to specify board assembly profiles. Actual board assembly profiles must be based on the customer's specific board design, solder paste and process, and should not exceed the parameters as the Reflow profile shows.]

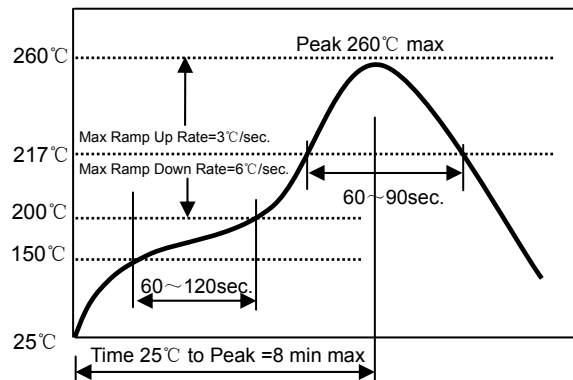

7.2 Iron Soldering Profile.

- △ Iron soldering power: Max. 30W
- △ Pre-heating: $150^\circ\text{C} / 60$ sec.
- △ Soldering Tip temperature: 350°C Max.
- △ Soldering time: 3sec. Max.
- △ Solder paste: Sn/3.0Ag/0.5Cu
- △ Max.1 times for iron soldering

[Note: Take care not to apply the tip of the soldering iron to the terminal electrodes.]

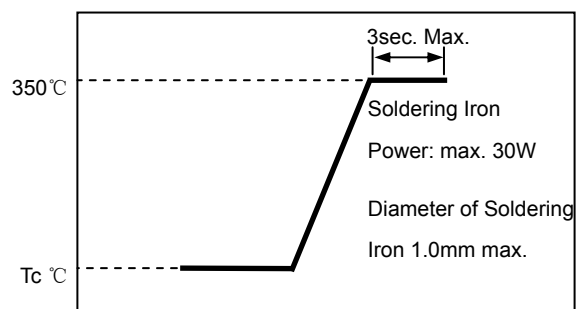

8. Supplier Information

- a) Supplier:
Shenzhen Sunlord Electronics Co., Ltd.
- b) Manufacturer:
Shenzhen Sunlord Electronics Co., Ltd.
- c) Manufacturing Address:
Sunlord Industrial Park, Dafuyuan Industrial Zone, Guanlan, Shenzhen, China 518110

Appendix A: Electrical Characteristics (SDCL1005 Series of Inductors)

SDCL1005 Series of Inductors

Part Number	L (nH)	Q Min.	L, Q Test. Freq (MHz)	Q (Typ.) Freq. (MHz)			S.R.F (MHz) Min	DCR (Ω) Max.	I _r (mA) Max.	Thickness (mm) [inch]
				100	800	1000				
SDCL1005C0N6□TDF	0.6	4	100	6	35	41	10000	0.10	800	0.5±0.15 [.020±.006]
SDCL1005C1N0□TDF	1.0	8	100	11	34	36	10000	0.10	400	
SDCL1005C1N1□TDF	1.1	8	100	11	34	36	10000	0.10	400	
SDCL1005C1N2□TDF	1.2	8	100	11	34	36	10000	0.10	400	
SDCL1005C1N3□TDF	1.3	8	100	11	34	36	10000	0.10	400	
SDCL1005C1N5□TDF	1.5	8	100	11	34	36	6000	0.10	300	
SDCL1005C1N6□TDF	1.6	8	100	11	32	35	6000	0.10	300	
SDCL1005C1N8□TDF	1.8	8	100	11	30	34	6000	0.10	300	
SDCL1005C2N0□TDF	2.0	8	100	10	29	33	6000	0.20	300	
SDCL1005C2N2□TDF	2.2	8	100	10	29	33	6000	0.20	300	
SDCL1005C2N4□TDF	2.4	8	100	10	29	32	6000	0.20	300	
SDCL1005C2N7□TDF	2.7	8	100	10	29	32	6000	0.20	300	
SDCL1005C3N0□TDF	3.0	8	100	10	29	32	6000	0.20	300	
SDCL1005C3N3□TDF	3.3	8	100	10	29	32	6000	0.20	300	
SDCL1005C3N6□TDF	3.6	8	100	10	28	31	4000	0.20	300	
SDCL1005C3N9□TDF	3.9	8	100	10	28	31	4000	0.20	300	
SDCL1005C4N3□TDF	4.3	8	100	10	28	31	4000	0.20	300	
SDCL1005C4N7□TDF	4.7	8	100	10	28	31	4000	0.20	300	
SDCL1005C5N1□TDF	5.1	8	100	10	28	30	4000	0.30	300	
SDCL1005C5N6□TDF	5.6	8	100	10	28	30	4000	0.30	300	
SDCL1005C6N2□TDF	6.2	8	100	10	27	30	3900	0.30	300	
SDCL1005C6N8□TDF	6.8	8	100	10	27	30	3900	0.30	300	
SDCL1005C7N5□TDF	7.5	8	100	10	27	30	3700	0.40	300	
SDCL1005C8N2□TDF	8.2	8	100	10	27	30	3600	0.40	300	
SDCL1005C9N1□TDF	9.1	8	100	10	27	30	3400	0.40	300	
SDCL1005C10N□TDF	10	8	100	10	27	30	3200	0.40	300	
SDCL1005C12N□TDF	12	8	100	10	26	29	2700	0.50	300	
SDCL1005C15N□TDF	15	8	100	10	26	28	2300	0.50	300	
SDCL1005C18N□TDF	18	8	100	10	25	27	2100	0.60	300	
SDCL1005C20N□TDF	20	8	100	10	25	26	2000	0.60	300	
SDCL1005C22N□TDF	22	8	100	10	25	25	1900	0.60	300	
SDCL1005C27N□TDF	27	8	100	10	25	23	1600	0.70	300	
SDCL1005C33N□TDF	33	8	100	10	22	22	1300	0.80	200	
SDCL1005C39N□TDF	39	8	100	10	22	19	1200	1.00	200	
SDCL1005C43N□TDF	43	8	100	10	21	16	1100	1.10	200	
SDCL1005C47N□TDF	47	8	100	10	21	16	1000	1.10	200	
SDCL1005C56N□TDF	56	8	100	10	18	13	750	1.20	200	
SDCL1005C68N□TDF	68	8	100	10	18	9	750	1.40	180	
SDCL1005C82N□TDF	82	8	100	10	13	-	750	2.40	150	
SDCL1005CR10□TDF	100	8	100	10	12	-	700	2.60	150	
SDCL1005CR12□TDF	120	8	100	10	-	-	600	2.80	150	
SDCL1005CR15□TDF	150	8	100	10	-	-	550	3.20	100	
SDCL1005CR18□TDF	180	8	100	10	-	-	500	3.70	100	
SDCL1005CR22□TDF	220	8	100	12	-	-	450	4.00	100	
SDCL1005CR27□TDF	270	8	100	12	-	-	400	4.50	100	
SDCL1005CR30□TDF	300	8	100	12	-	-	400	4.50	100	
SDCL1005CR33□TDF	330	6	50	8	-	-	350	7.00	50	
SDCL1005CR36□TDF	360	6	50	8	-	-	300	7.50	50	

※□: Please specify the inductance tolerance. For L≤6.2nH, choose B=±0.1nH, C=±0.2nH or S=±0.3nH; For L>6.2nH, choose H=±3%, J=±5% or K=±10%.