

CN 网络电阻器 (贴片) Chip Networks (Concave Termination)

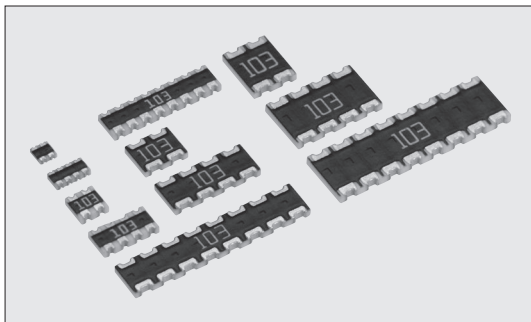

外观颜色: 黑色 (电阻, CNZ1E2, CNZ1E4)、绿色 (Jumper)
Coating color: Black (Resistor CNZ1E2, CNZ1E4)、Green (Jumper)
CN1E2、CN1E4、Jumper: 没有标识
CN1E2、CN1E4、Jumper: No marking

特点 Features

- 比贴片电阻具有更高的安装密度。
- 部件安装次数的减少降低了安装成本。
- 有2联, 4联, 8联装的表面贴装电阻阵列。
- 拥有±1%的精确度。
- 在回流焊接时具有更好的自定位性能。
- 安装时易于进行图像识别。
- 适用于回流焊接和波峰焊。
- 端子无铅品, 符合欧盟RoHS。电极、电阻膜层、玻璃中所含的铅玻璃不适用欧盟RoHS指令。
- AEC-Q200相关数据已取得。(CN1J4)
- More advancement in the mounting density than individual chip resistors.
- Mounting cost reduction by decreasing the number of parts mounting times.
- 2, 4 and 8 elements of SMD resistor arrays are available.
- Precision type ±1% is available.
- Higher self-alignment effect in reflow-soldering process.
- Suitable for an image recognition mounter due to square corner design.
- Suitable for both reflow and flow solderings.
- Products with lead free termination meet EU-RoHS requirements. EU-RoHS regulation is not intended for Pb-glass contained in electrode, resistor element and glass.
- AEC-Q200 Qualified (CN1J4).

参考标准 Reference Standards

IEC 60115-1
JIS C 5201-1

额定值 Ratings

型号 Type	额定功率 Power Rating (W/Element)	额定 周围温度 Max. Overload Voltage	额定 端子部温度 Rated Terminal Part Temp.	电阻值范围 Resistance Range (Ω)			电阻温度系数 T.C.R. (×10 ⁻⁶ /K)		最高 使用电压 Max. Working Voltage	最高 过载电压 Max. Overload Voltage	使用温度范围 Max. Overload Voltage	编带和包装数/卷 Taping & Q'ty / Reel (pcs)	
				F: ±1% E24·E96	G: ±2% E24	J: ±5% E24	F: ±1%	J: ±5%、 G: ±2%				TD	TE
CN1E2 CN1E4	0.063	+70°C	+125°C	-	-	10~100k	-	±200: R ≥ 10Ω ±400: R < 10Ω	25V	50V	-55°C~ +125°C	10,000	-
CN1J2 CN1J4 CN1J8	0.063			10~1M	±100: R ≥ 10Ω	50V	100V		-55°C~ +155°C	5,000	-		
CN2A2 CN2A4 CN2A8	0.1			10~1M	±200: R ≥ 10Ω	100V	200V			-	4,000		
CN2B2 CN2B4 CN2B8	0.125			10~1M	±200: R ≥ 10Ω	200V	400V		-	4,000			
											2,000		

按照额定功率使用时, 比单一的贴片电阻的发热温度高, 在使用时请加以注意。

Please note that network resistors generate higher heat rather than single flat chip resistor even under rated power output.

额定电压 = √(额定功率 × 公称电阻值) 所算出的值或表中最高使用电压两者中的小的值为额定电压。

Rated voltage = √(Power Rating × Resistance value or Max. working voltage, whichever is lower).

根据客户的使用状况, 如果不清楚是该使用额定环境温度还是额定端子部温度, 请以额定端子部温度为优先。

详情请参照14~17页的“端子部温度负荷特性曲线的说明”。

If any questions arise whether to use the "Rated Ambient Temperature" or the "Rated Terminal Part Temperature" in your usage conditions, please give priority to the "Rated Terminal Part Temperature".

For more details, please refer to "Introduction of the derating curves based on the terminal part temperature" in page 14 to 17.

电路构成 Circuit Construction

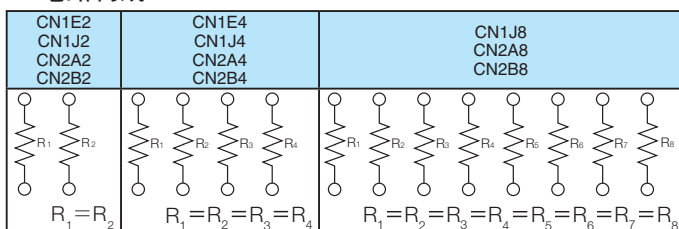

结构图 Construction

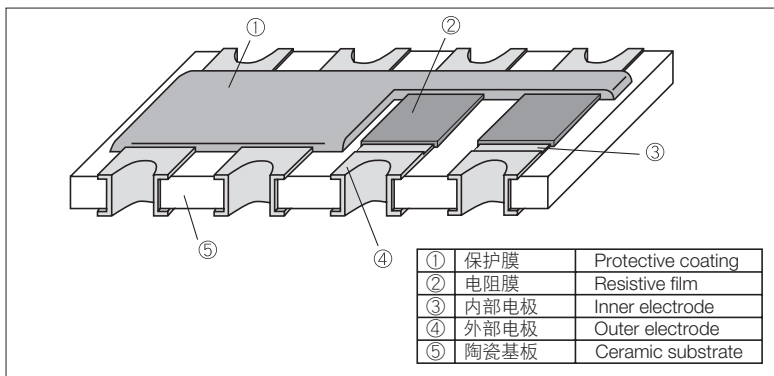

品名构成 Type Designation

实例 Example	品种 Product Code	形状 Size	元件数 Number of Resistors	端子表面材质 Terminal Surface Material	二次加工 Taping	公称电阻值 Nominal Resistance	阻值允许偏差 Resistance Tolerance
CN	1J	4	T	TD	103	J	
		1E 1J 2A 2B	2 4 8	T: Sn ^{※1} (L: Sn/Pb)	TD: Paper TE: Plastic embossed BK: Bulk	F: 4 digits G, J: 3 digits	F: ±1% G: ±2% J: ±5%

端子表面材质, 以无铅品为准。

欲知关于此产品含有的环境负荷物质详情 (除EU-RoHS以外), 请与我们联系。

编带细节请参考卷末附录C。

The terminal surface material lead free is standard.

Contact us when you have control request for environmental hazardous material other than the substance specified by EU-RoHS.

For further information on taping, please refer to APPENDIX C on the back pages.

※1 1E尺寸只对应表面端子材质T。

※1 Only terminal surface material T is available for 1E type.

用途 Applications

- 用于数字电路的阻尼电阻, 上拉/下拉电阻和终端电阻。
- 限制LED的电流。
- 用于SDRAM的终端 (适用于1~10Ω的5%)。
- Resistors for Damping, Pull-up/Pull-down, Termination for digital circuits.
- LED current limiting.
- Terminals for SDRAM. (1~10Ω, 5% available)

跳线额定 Jumper Ratings

型号 Type	电阻值 Resistance	额定电流 Current Rating	最大浪涌电流 Max. Surge Current
CNZ1E2 CNZ1E4 CNZ1J2 CNZ1J4 CNZ1J8 CNZ2A2 CNZ2A4 CNZ2B2 CNZ2B4	50mΩ以下 50mΩ max.	0.5A 1A	2A 3A 4A

本产品目录中记载的产品规格如有变更, 恕不一一奉告。订购以及使用之前, 请仔细确认规格表的内容。

用于车载设备、医疗设备、航空设备以及其他涉及人身安全、或可能引起重大损失的设备上时, 请务必事先与我公司联系。这些产品在这类用途中出现故障或失灵可能导致人身事故或严重损坏。

Specifications given herein may be changed at any time without prior notice. Please confirm technical specifications before you order and/or use.

Contact our sales representatives before you use our products for applications including automobiles, medical equipment and aerospace equipment.

Malfunction or failure of the products in such applications may cause loss of human life or serious damage.

Nov. 2017

外形尺寸 Dimensions

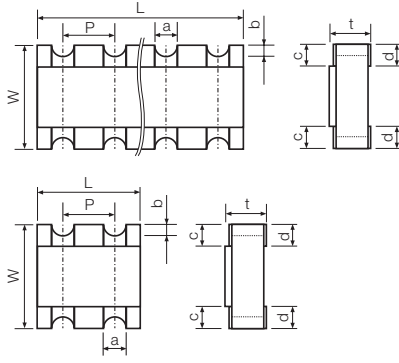

型号 Type (Inch Size Code)	尺寸 Dimensions (mm)									Weight (g) (1000pcs)
	L	W	c	d±0.1	t	a (top)	a (bottom)	b	P	
CN1E2 (0402×2)	1.0±0.1	1.0±0.1	0.2±0.1	0.25	0.35±0.1	0.3±0.1	0.3±0.1	0.07±0.05	(0.50)	1.2
CN1E4 (0402×4)	2.0±0.1				0.45±0.1					3.1
CN1J2 (0603×2)	1.6±0.2	1.6±0.2	0.3±0.2	0.40	0.6±0.1	0.5±0.1	0.4±0.15	0.15±0.1	(0.80)	5.6
CN1J4 (0603×4)	3.2±0.2									10.2
CN1J8 (0603×8)	6.4±0.2	2.0±0.2	0.4±0.2	0.55	0.6±0.1	0.8±0.1	0.75±0.15	0.15±0.1	(1.27)	21.3
CN2A2 (0805×2)	2.54±0.2									9.4
CN2A4 (0805×4)	5.08±0.2	2.0±0.2	0.4±0.2	0.55	0.6±0.1	0.8±0.1	0.75±0.15	0.15±0.1	(1.27)	20.6
CN2A8 (0805×8)	10.16±0.2									39.4
CN2B2 (1205×2)	2.54±0.2	3.2±0.2	0.5±0.3	0.55	0.6±0.1	0.8±0.1	0.75±0.15	0.15±0.1	(1.27)	17.6
CN2B4 (1205×4)	5.08±0.2									33.5
CN2B8 (1205×8)	10.16±0.2									64.3

() 内的数值作为参考。 Figures in parenthesis are referential values.

负荷减轻特性曲线 Derating Curve

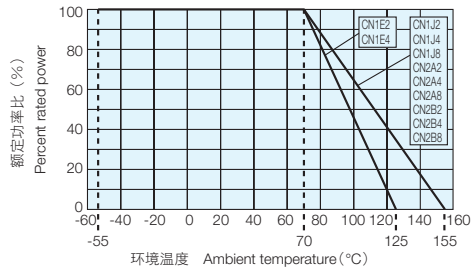

在环境温度70°C以上使用时，应按照上图负荷减轻特性曲线，减小额定功率。
For resistors operated at an ambient temperature of 70°C or above, a power rating shall be derated in accordance with the above derating curve.

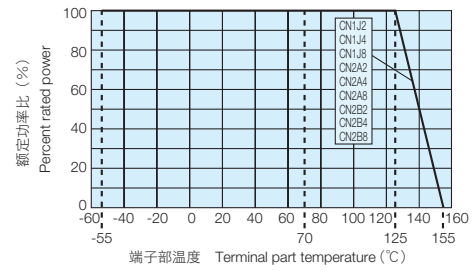

超过端子部温度使用时，请根据上图负荷减轻特性曲线减小额定功率后使用。
For resistors operated terminal part temperature of described for each size or above, a power rating shall be derated in accordance with derating curve.

性能 Performance

试验项目 Test Items	标准值 Performance Requirements $\Delta R \pm (\% + 0.1 \Omega)$		试验方法 Test Methods
	保证值 Limit	代表值 Typical	
电阻值 Resistance	在规定的允许偏差内 Within specified tolerance		25°C
电阻温度系数 T.C.R.	在规定的允许偏差内 Within specified T.C.R.		+25°C/-55°C and +25°C/+125°C
过载 (短时间) Overload (Short time)	2	0.5	额定电压×2.5倍施加5秒钟 Rated voltage × 2.5 for 5s
耐焊接热 Resistance to soldering heat	1	0.25	260°C ± 5°C, 10s ± 1s
温度突变 Rapid change of temperature	1	0.5	-55°C (30min.) / +125°C (30min.) 5 cycles
耐湿负荷 Moisture resistance	5	1	40°C ± 2°C, 90%~95%RH, 1000h 1.5小时ON、0.5小时OFF的周期 1.5h ON/0.5h OFF cycle
在70°C时的耐久性 Endurance at 70°C	5	0.5	70°C ± 2°C, 1000h 1.5小时ON、0.5小时OFF的周期 1.5h ON/0.5h OFF cycle
高温放置 High temperature exposure	1	0.2: CN1E2、CN1E4	+125°C, 1000h CN1E2, CN1E4
		0.3: another	+155°C, 1000h CN1J2, CN1J4, CN1J8 CN2A2, CN2A4, CN2A8 CN2B2, CN2B4, CN2B8

应用范例 Examples For Circuit Board Application

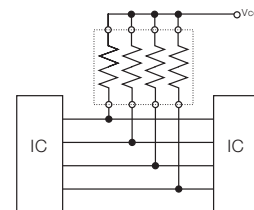
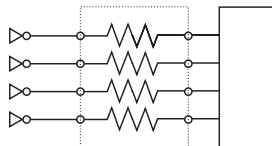

使用注意事项 Precautions for Use

- 网络电阻器偶尔会发生串扰的情况，当把它们用于高频电路时，在电路设计时请考虑串扰的影响。
- A few cross talks will occur in network resistors. In case of using them for a high frequency circuit, please design circuits taking the effect by the cross talks into consideration.