

RoHS Device  
Halogen Free



### Features

- IEC61000-4-2 Level 4 ESD protection.
- Working voltage: 3.3V
- Low leakage current.
- Low operating and clamping voltages.

### Mechanical data

- Case: SOD-523 standard package ,molded plastic.
- Terminals: Solderable per MIL-STD-750, method 2026.
- Mounting position: Any
- Weight: 0.0012 gram(approx.).

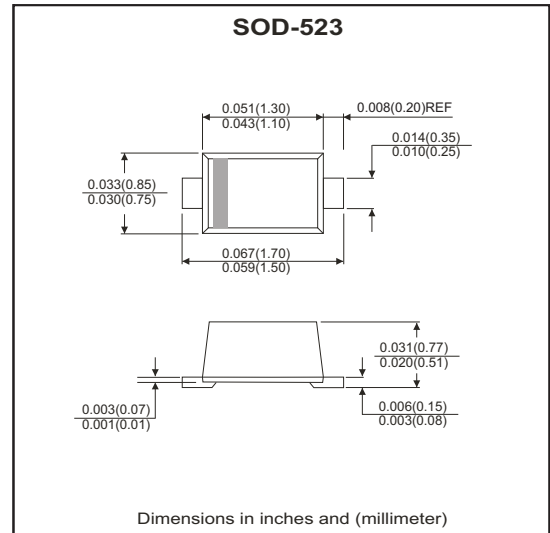

### Circuit Diagram



### Maximum Ratings (at TA=25°C unless otherwise noted)

Parameter	Symbol	Value	Unit
Peak pulse power ( tp = 8/20 us)	PPP	130	W
Peak pulse current ( tp = 8/20 us)	IPP	5	A
ESD per IEC 61000-4-2(Air) ESD per IEC 61000-4-2(Contact)	VESD	±20 ±15	kV
Operating temperature	Tj	-55 to +125	°C
Storage temperature	TSTG	-55 to +125	°C

### Electrical Characteristics (at TA=25°C unless otherwise noted)

Parameter	Conditions	Symbol	Min	Typ	Max	Unit
Reverse stand-off voltage		VRWM			3.3	V
Reverse breakdown voltage	IBR = 1 mA	VBR	5.0			V
Snap-back voltage	ISB = 50mA	VSB	2.8			V
Reverse leakage current	VRWM = 3.3V	IR		0.5	2	uA
Clamping voltage	IPP = 1 A, tp=8/20us	Vc			5.5	V
	IPP = 5 A, tp=8/20us	Vc			8.0	V
Reverse clamping voltage	IPPR = 1 A, tp=8/20us	VCR			2.4	V
Junction capacitance	VR = 0 V, f = 1MHz	Cj		105		pF

### RATING AND CHARACTERISTIC CURVES (PESD3V3S1UB)

Fig. 1 - Non-repetitive max. peak pulse power vs. pulse time

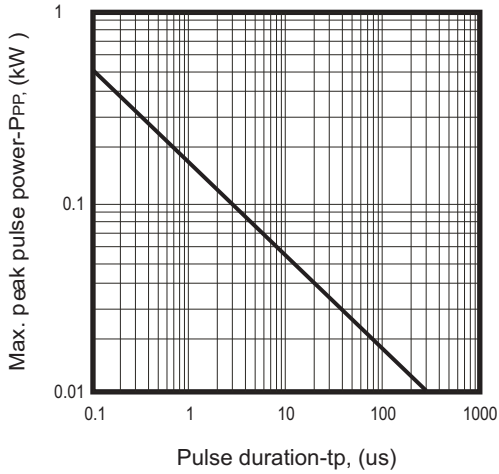

Fig. 2 - Power rating derating curve

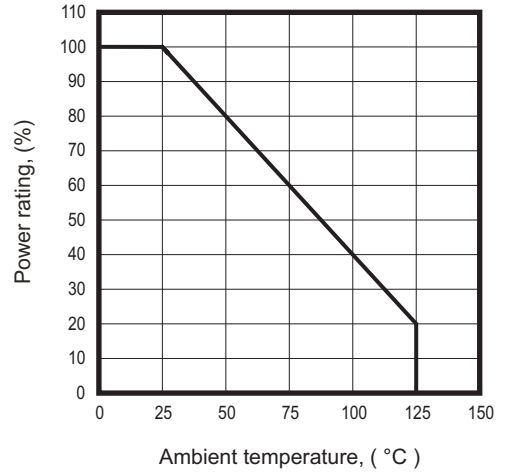

Fig.3 - Clamping voltage vs. peak pulse current

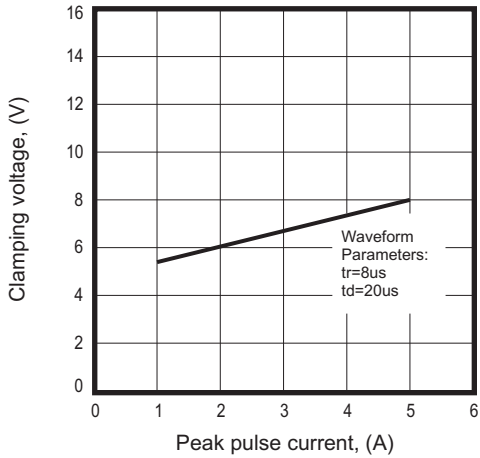

Fig.4 - Forward voltage vs. Forward current

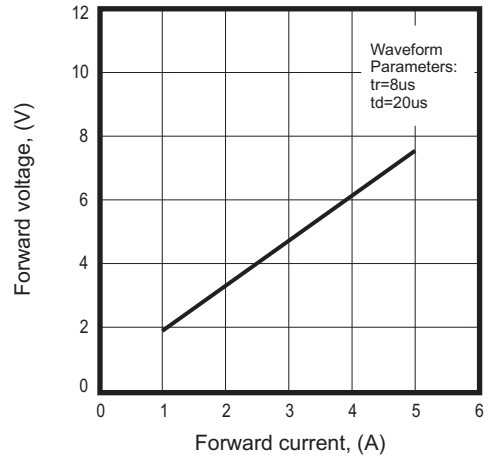
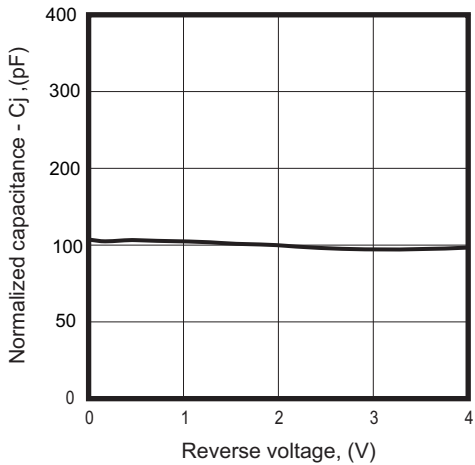
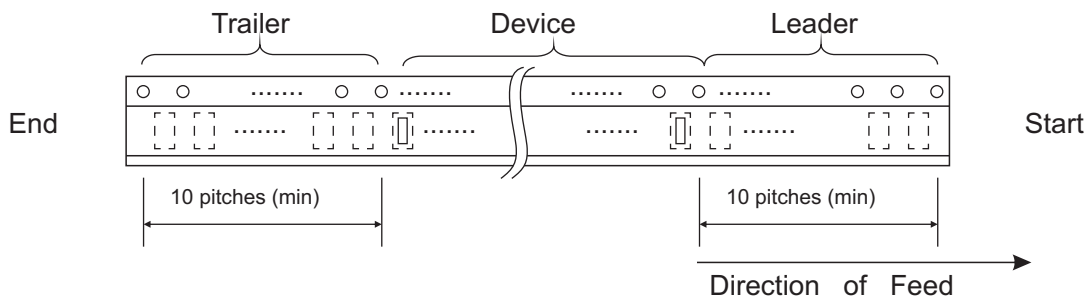
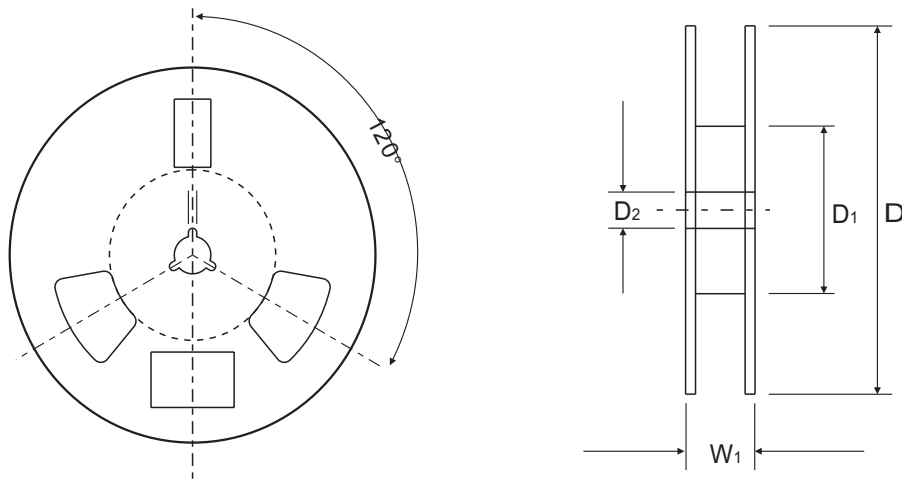
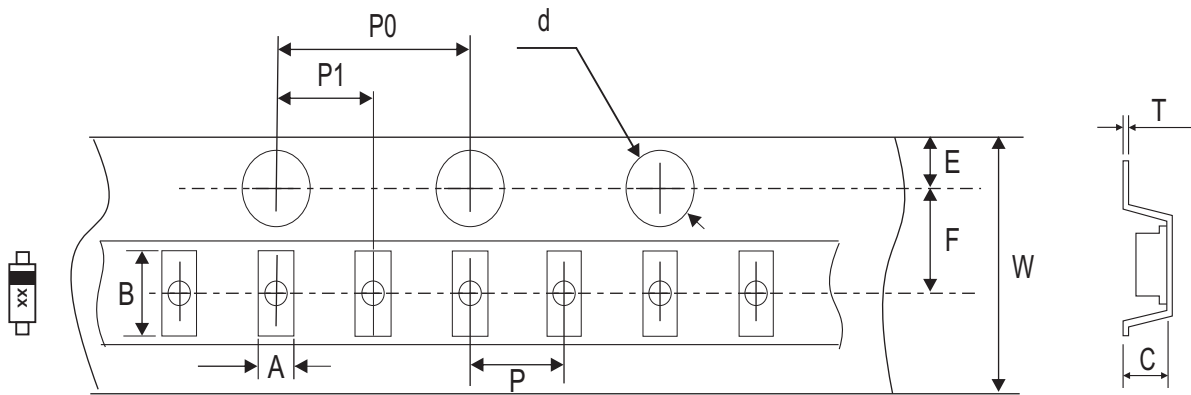

Fig.5 - Junction capacitance vs. reverse voltage



### Reel Taping Specification



SOD-523	SYMBOL	A	B	C	d	D	D <sub>1</sub>	D <sub>2</sub>
	(mm)	0.90 ± 0.05	1.94 ± 0.05	0.73 ± 0.05	1.50 ± 0.10	178.00 ± 2.00	54.40 ± 1.00	13.00 ± 1.00
	(inch)	0.035 ± 0.002	0.076 ± 0.002	0.029 ± 0.002	0.059 ± 0.004	7.008 ± 0.079	2.142 ± 0.039	0.512 ± 0.039

SOD-523	SYMBOL	E	F	P	P <sub>0</sub>	P <sub>1</sub>	W	W <sub>1</sub>
	(mm)	1.75 ± 0.10	3.50 ± 0.10	2.00 ± 0.10	4.00 ± 0.10	2.00 ± 0.10	8.00 + 0.30 / -0.10	12.30 ± 1.00
	(inch)	0.069 ± 0.004	0.138 ± 0.004	0.079 ± 0.004	0.157 ± 0.004	0.079 ± 0.004	0.315 + 0.012 / -0.004	0.484 ± 0.039

### Suggested PAD Layout

SIZE	SOD-523	
	(mm)	(inch)
A	1.42	0.055
B	0.60	0.024
C	0.70	0.028
D	2.02	0.079
E	0.82	0.031

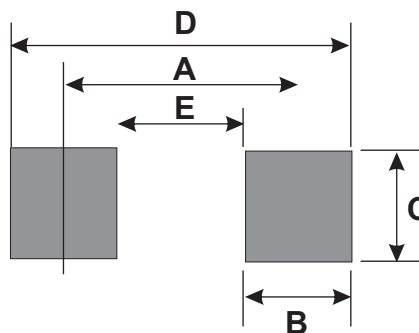

### Standard Packaging

Case Type	REEL PACK	
	REEL (pcs)	Reel Size (inch)
SOD-523	3,000	7