

Transient Voltage Suppressors for ESD Protection

ESDXXV32D-C Series

Description

The ESDXXV32D-C is designed to protect voltage sensitive components from ESD and transient voltage events. Excellent clamping capability, low leakage, and fast response time, make these parts ideal for ESD protection on designs where board space is at a premium. Because of its small size, it is suited for use in cellular phones, MP3 players, digital cameras and many other portable applications where board space is at a premium.

Feature

- ◆ 320 Watts Peak Pulse Power per Line (tp=8/20µs)
- ◆ Protects one I/O line or power line
- ◆ Low clamping voltage
- ◆ Working voltages : 3V, 5V, 8V, 12V, 15V, 18V, 24V, 36V and 48V
- ◆ Low leakage current
- ◆ IEC61000-4-2 (ESD) ±15kV (air), ±8kV (contact)
- ◆ IEC61000-4-4 (EFT) 40A (5/50ns)
- ◆ IEC61000-4-5 (Lightning) 24A (8/20µs)

Applications

- ◆ Cell Phone Handsets and Accessories
- ◆ Microprocessor based equipment
- ◆ Personal Digital Assistants (PDA's)
- ◆ Notebooks, Desktops, and Servers
- ◆ Portable Instrumentation
- ◆ Peripherals
- ◆ Pagers

SOD-323

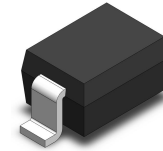

Functional Diagram

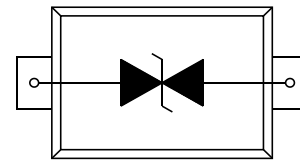

Mechanical Characteristics

- ◆ JEDEC SOD-323 Package
- ◆ Molding Compound Flammability Rating : UL 94V-0
- ◆ Weight 5 Milligrams (Approximate)
- ◆ Quantity Per Reel : 3,000pcs
- ◆ Reel Size : 7 inch
- ◆ Lead Finish : Lead Free

Mechanical Characteristics

Symbol	Parameter	Value	Units
P _{PP}	Peak Pulse Power (tp=8/20µs waveform)	320	W
T _L	Lead Soldering Temperature	260 (10sec)	°C
T _{STG}	Storage Temperature Range	-55 to +150	°C
T _{OP}	Operating Temperature Range	-55 to +150	°C
	IEC61000-4-2 (ESD)	Air Discharge ±15 Contact Discharge ±8	KV
	IEC61000-4-4 (EFT)	40	A
	IEC61000-4-5 (Lightning)	24	A

Transient Voltage Suppressors for ESD Protection

ESDXXV32D-C Series

I-V Curve Characteristics

Symbol	Parameter
I_{PP}	Maximum Reverse Peak Pulse Current
V_C	Clamping Voltage @ I_{PP}
V_{RWM}	Working Peak Reverse Voltage
I_R	Maximum Reverse leakage Current @ V_{RWM}
I_T	Test Current
V_B	Breakdown Voltage @ I_T

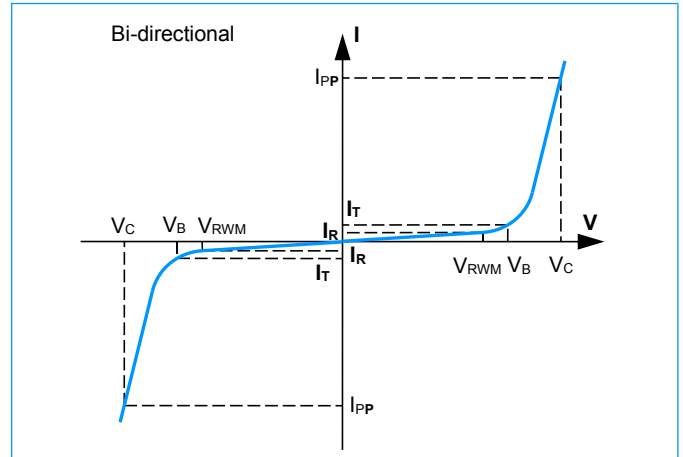

Electrical Characteristics (@ 25°C Unless Otherwise Specified)

Part Number	V_{RWM} (V) (Max.)	V_B (V) (Min.)	I_T (mA)	V_C @1A (Max.)	V_C		I_R (μ A) (Max.)	C (pF) (Typ.)
					(Max.)	(@A)		
ESD03V32D-C	3.3	4.0	1	7.5	16	25	200	350
ESD05V32D-C	5	6.0	1	9.8	17	24	10	260
ESD08V32D-C	8	8.5	1	13.4	20	18	5	120
ESD12V32D-C	12	13.3	1	19	25	13	1	110
ESD15V32D-C	15	16.7	1	24	30	6	1	100
ESD18V32D-C	18	19.0	1	28	35	8	1	90
ESD24V32D-C	24	26.7	1	43	52	6	1	75
ESD36V32D-C	36	40	1	60	75	4	1	35
ESD48V32D-C	48	50	1	65	85	3	1	25

Characteristic Curves

Fig1. 8/20 μ s Pulse Waveform

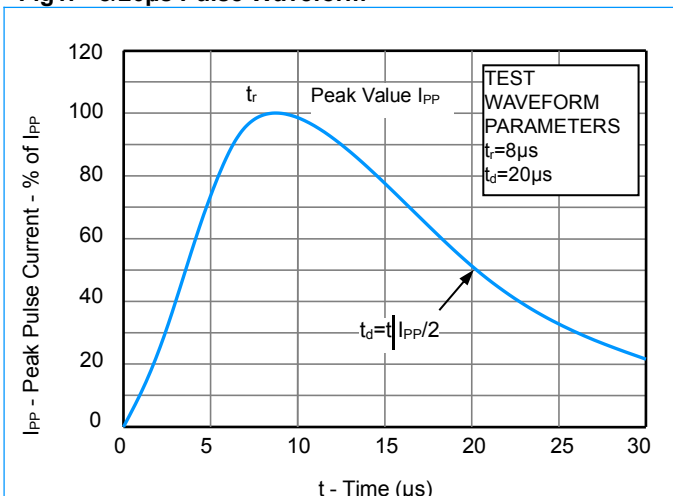
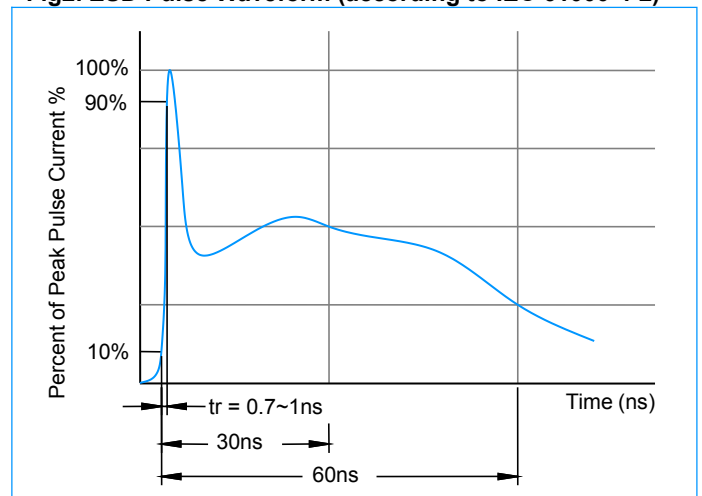

Fig2. ESD Pulse Waveform (according to IEC 61000-4-2)



Transient Voltage Suppressors for ESD Protection

ESDXXV32D-C Series

Characteristic Curves

Fig3. ESD Clamping (+8KV Contac per IEC61000-4-2)

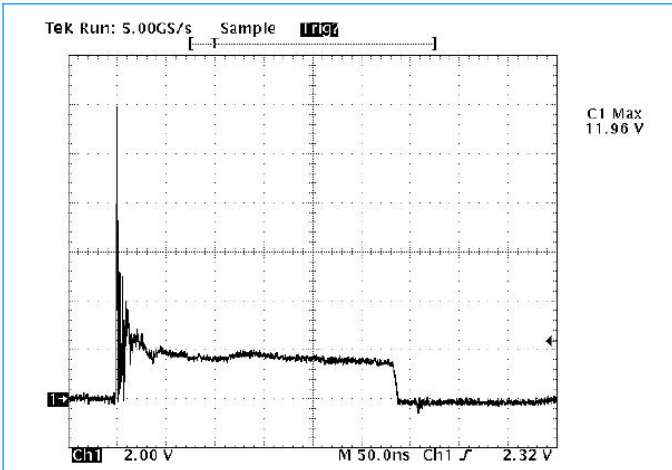
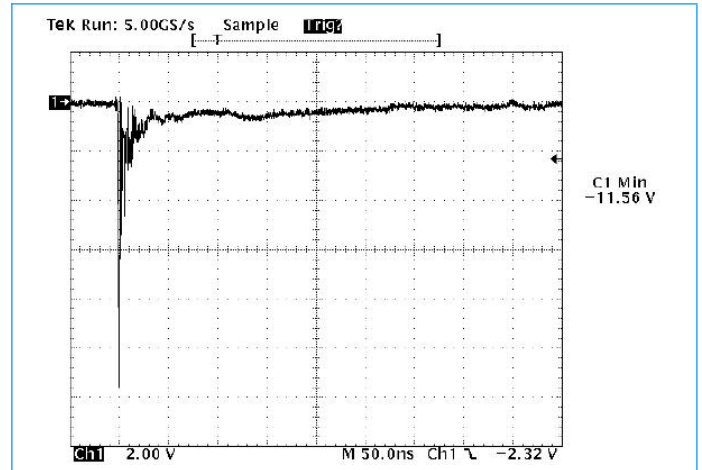
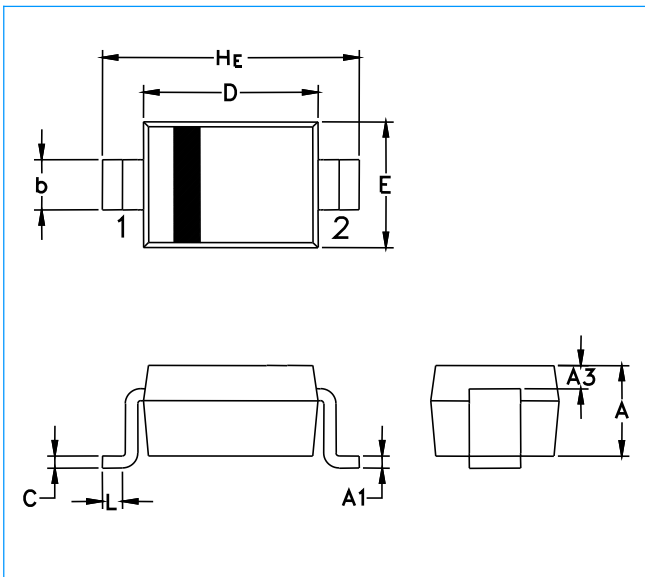

Fig4. ESD Clamping (-8KV Contac per IEC61000-4-2)



SOD-323 Package Outline & Dimensions



Symbol	Millimeters			Inches		
	Min.	Nom.	Max.	Min.	Nom.	Max.
A	0.80	0.90	1.00	0.031	0.035	0.040
A1	0.00	0.05	0.10	0.000	0.002	0.004
A3	0.15 REF			0.006 REF		
b	0.25	0.32	0.40	0.010	0.012	0.016
C	0.089	0.12	0.177	0.003	0.005	0.007
D	1.60	1.70	1.80	0.062	0.066	0.070
E	1.15	1.25	1.35	0.045	0.049	0.053
L	0.08			0.003		
HE	2.30	2.50	2.70	0.090	0.098	0.105

Soldering Footprint

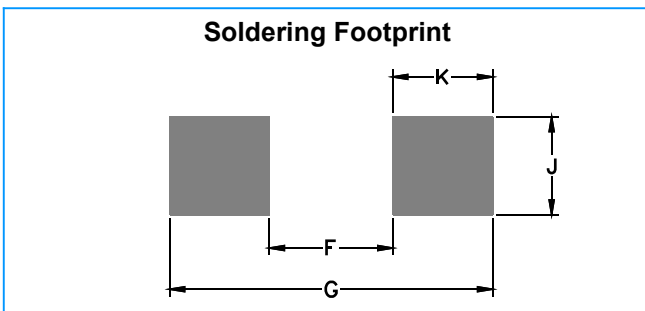

Symbol	Millimeters	Inches
F	1.60	0.063
G	2.85	0.112
J	0.83	0.033
K	0.63	0.025