

Surface Mount Resettable PTCs

SCF1812 Series

Description

The SCF1812 Series PTC provides surface mount over-current protection for applications where space is at a premium and resettable protection is desired.

Features

- u RoHS compliant, Lead-Free and Halogen-Free
- u Fast time-to-trip
- u Compact design saves board space
- u Low resistance
- u Low-profile

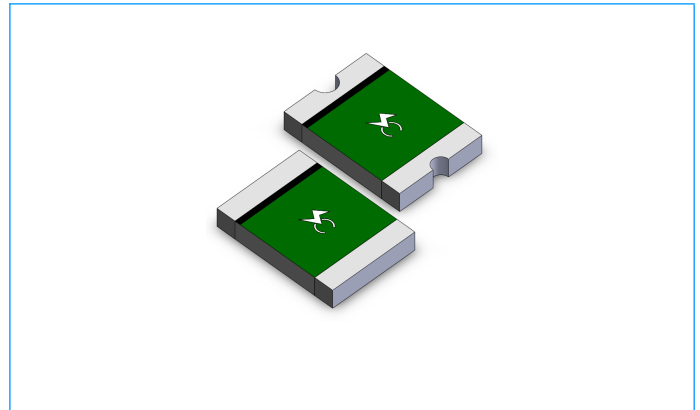

Applications

- u PC motherboard - plug and play protection
- u Mobile phones - battery and port protection
- u Game console port protection
- u USB peripherals
- u Disk drive
- u PDAS / digital cameras
- u Power ports
- u General electronics

Electrical Parameters

Part Number	Hold Current	Trip Current	Rated Voltage	Max Current	Typical Power	Maximum Time To Trip		Resistance	
	I_{hold} (A)	I_{trip} (A)	V_{max} (Vdc)	I_{max} (A)	$P_{dtyp.}$ (W)	Current (A)	Time (Sec.)	R_{min} (Ω)	R_{1max} (Ω)
SCF010-1812	0.10	0.30	60	100	0.8	8.0	0.020	1.600	15.00
SCF010-1812R	0.10	0.30	60	100	0.8	8.0	0.020	1.600	15.00
SCF014-1812	0.14	0.30	60	100	0.8	8.0	0.008	1.200	6.500
SCF014-1812R	0.14	0.30	60	100	0.8	8.0	0.008	1.200	6.500
SCF020-1812	0.20	0.40	30	100	0.8	8.0	0.020	0.800	5.000
SCF020-1812R	0.20	0.40	30	100	0.8	8.0	0.020	0.800	5.000
SCF020-60-1812R	0.20	0.40	60	40	0.8	8.0	0.020	0.800	5.000
SCF030-1812R	0.30	0.60	30	100	0.8	8.0	0.100	0.200	1.750
SCF035-1812	0.35	0.70	16	100	0.8	8.0	0.100	0.320	1.500
SCF035-1812R	0.35	0.70	16	100	0.8	8.0	0.100	0.320	1.500
SCF035-30-1812R	0.35	0.70	30	100	0.8	8.0	0.100	0.320	1.500
SCF050-1812	0.50	1.00	16	100	0.8	8.0	0.150	0.150	1.000
SCF050-1812R	0.50	1.00	16	100	0.8	8.0	0.150	0.150	1.000
SCF050-30-1812R	0.50	1.00	30	100	0.8	8.0	0.150	0.150	1.000
SCF075-1812	0.75	1.50	16	100	0.8	8.0	0.200	0.110	0.450
SCF075-1812R	0.75	1.50	16	100	0.8	8.0	0.200	0.110	0.450
SCF075-24-1812R	0.75	1.50	24	40	1.0	8.0	0.200	0.110	0.290
SCF075-33-1812R	0.75	1.50	33	40	1.0	8.0	0.200	0.110	0.400
SCF110-1812	1.10	2.20	8	100	0.8	8.0	0.300	0.040	0.210
SCF110-1812R	1.10	2.20	8	100	0.8	8.0	0.300	0.040	0.210
SCF110-16-1812	1.10	2.20	16	100	0.8	8.0	0.500	0.040	0.180
SCF110-16-1812R	1.10	2.20	16	100	0.8	8.0	0.500	0.040	0.180
SCF110-24-1812R	1.10	2.20	24	100	1.0	8.0	0.500	0.060	0.200
SCF110-33-1812R	1.10	2.20	33	100	0.8	8.0	0.500	0.060	0.200

Surface Mount Resettable PTCs

SCF1812 Series

Electrical Parameters (Continue)

SCF125-1812	1.25	2.50	6	100	0.8	8.0	0.400	0.050	0.140
SCF125-1812R	1.25	2.50	6	100	0.8	8.0	0.400	0.050	0.140
SCF125-16-1812R	1.25	2.50	16	100	0.8	8.0	0.400	0.050	0.140
SCF150-1812	1.50	3.00	8	100	0.8	8.0	0.500	0.040	0.110
SCF150-1812R	1.50	3.00	8	100	0.8	8.0	0.500	0.040	0.110
SCF150-12-1812R	1.50	3.00	12	100	1.0	8.0	0.500	0.040	0.110
SCF150-24-1812R	1.50	3.00	24	100	1.0	8.0	1.500	0.040	0.120
SCF160-1812	1.60	3.20	8	100	0.8	8.0	0.500	0.030	0.100
SCF160-1812R	1.60	3.20	8	100	0.8	8.0	0.500	0.030	0.100
SCF160-12-1812R	1.60	3.20	12	100	1.0	8.0	1.000	0.030	0.100
SCF160-16-1812R	1.60	3.20	16	100	1.0	8.0	1.000	0.030	0.100
SCF190-1812R	1.90	4.90	6	100	1.0	8.0	5.000	0.003	0.025
SCF200-1812R	2.00	3.50	8	100	1.0	8.0	2.000	0.020	0.070
SCF200-16-1812R	2.00	3.50	16	100	1.0	8.0	5.000	0.020	0.085
SCF260-1812R	2.60	5.00	8	100	1.0	8.0	2.500	0.015	0.047
SCF260-13-1812R	2.60	5.00	13.2	100	1.3	8.0	5.000	0.015	0.050
SCF260-16-1812R	2.60	5.00	16	100	1.3	8.0	5.000	0.015	0.050
SCF300-1812R	3.00	5.00	6	100	1.0	8.0	4.000	0.012	0.040

I_{hold} = Hold current: maximum current device will pass without tripping in 23°C still air.
 I_{trip} = Trip current: minimum current at which the device will trip in 23°C still air.
 V_{max} = Maximum voltage device can withstand without damage at rated current (I_{max})
 I_{max} = Maximum fault current device can withstand without damage at rated voltage (V_{max})
 P_{dtyp} = Power dissipated from device when in the tripped state at 23°C still air.
 R_{min} = Minimum resistance of device in initial (un-soldered) state.
 R_{1max} = Maximum resistance of device at 23°C measured one hour after tripping.
 Caution: Operation beyond the specified rating may result in damage and possible arcing and flame.

Temperature Derating Chart – I_{hold} (A)

Average Time Current Curves

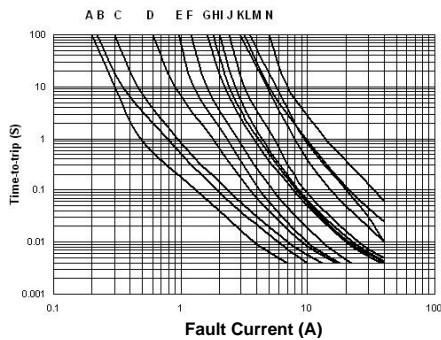

- A = SCF010-1812 /SCF010-1812R
- B = SCF014-1812 /SCF014-1812R
- C = SCF020-1812 /SCF020-1812R
- D = SCF020-60-1812R /SCF020-60-1812R
- E = SCF035-1812 /SCF035-1812R
- F = SCF050-1812 /SCF050-1812R
- G = SCF075-1812 /SCF075-24-1812R
- H = SCF110-1812 /SCF110-1812R
- I = SCF125-1812 /SCF125-16-1812R
- J = SCF150-1812 /SCF150-1812R
- K = SCF160-1812 /SCF160-12-1812R
- L = SCF200-1812R /SCF200-16-1812R
- M = SCF190-1812R /SCF260-1812R
- N = SCF300-1812R

Temperature Derating Curve

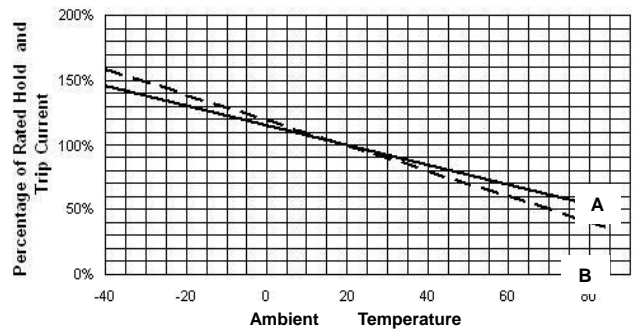

- A = SCF075-1812, SCF075-1812R, SCF075-24-1812R, SCF075-33-1812R, SCF110-1812, SCF110-1812R, SCF110-16-1812, SCF110-16-1812R, SCF110-24-1812R, SCF110-33-1812R, SCF125-1812, SCF125-1812R, SCF125-16-1812R, SCF150-1812, SCF150-1812R, SCF150-12-1812R, SCF150-24-1812R, SCF160-1812, SCF160-1812R, SCF160-12-1812R, SCF160-16-1812R, SCF190-1812R, SCF200-1812R, SCF200-16-1812R, SCF260-1812R, SCF260-13-1812R, SCF260-16-1812R, SCF300-1812R.
- B = SCF010-1812, SCF010-1812R, SCF014-1812, SCF014-1812R, SCF020-1812, SCF020-1812R, SCF020-60-1812R, SCF030-1812R, SCF035-1812, SCF035-1812R, SCF035-30-1812R, SCF050-1812, SCF050-1812R, SCF050-30-1812R.

Surface Mount Resettable PTCs

SCF1812 Series

Material Specifications

Terminal pad material	Pure Tin
Soldering Characteristics	Meets EIA specification RS 186-9E, ANSI/J-std-002 Category 3

Soldering Parameters

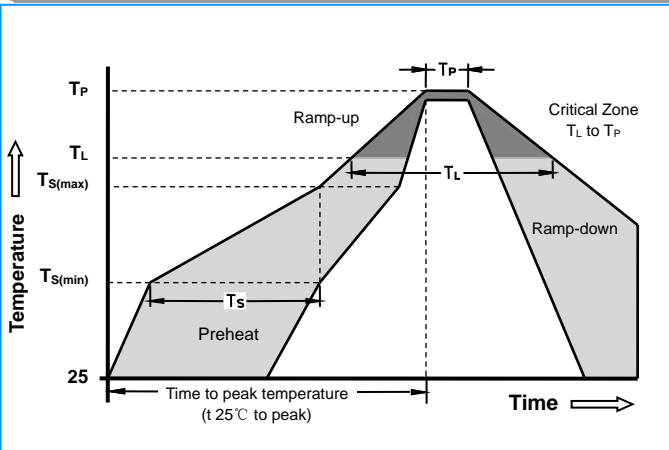

Profile Feature	Pb-Free Assembly
Average Ramp-Up Rate (Ts max to TP)	3°C/second max.
Preheat : Temperature Min (Tsmin) Temperature Max (Tsmax) Time (Tsmin to Tsmax)	150°C 200°C 60-180 seconds
Time maintained above: Temperature (TL) Time (TL)	217°C 60-150 seconds
Peak/Classification Temperature (TP):	260°C
Time within 5°C of actual peak: Temperature	20-40 seconds
Ramp-down Rate:	6°C/ second max.
Time 25°C to Peak Temperature	8 minutes max.

Note: All temperatures refer to of the package, measured on the package body surface.

Solder reflow

Due to "Lead Free" nature, Temperature and Dwelling time for the soldering zone is higher than those for Regular. This may cause damage to other components.

1. Recommended max past thickness > 0.25mm.
2. Devices can be cleaned using standard methods and aqueous solvent.
3. Rework use standard industry practices.
4. Storage Environment : < 30°C/ 60%RH

Caution:

1. If reflow temperatures exceed the recommended profile, devices may not meet the performance requirements.
2. Devices are not designed to be wave soldered to the bottom side of the board.

Part Numbering

SCF XXX – XX– 1812R

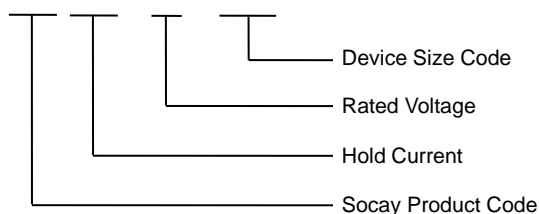

Part Marking

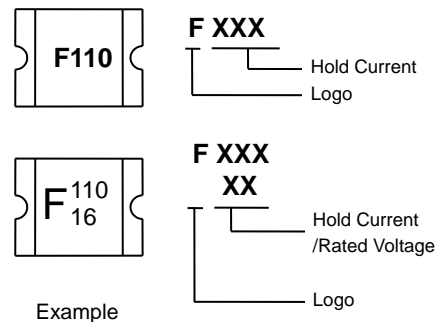

Pad Layouts Unit: mm

The dimension in the table below provide the recommended pad layout for each SCF1812 device

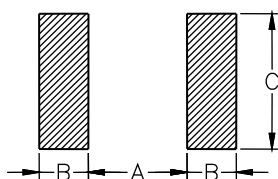

Device	A	B	C
	Nominal	Nominal	Nominal
1812 Series	3.45	1.78	3.50

Surface Mount Resettable PTCs

SCF1812 Series

Dimensions (Unit: mm)

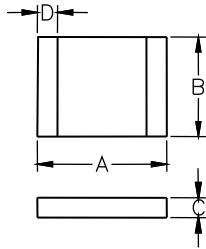

Figure1

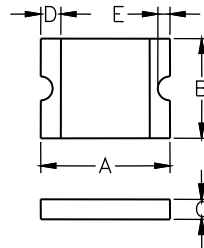

Figure2

Part Number	Figure	A		B		C		D		E	
		Min.	Max.	Min.	Max.	Min.	Max.	Min.	Max.	Min.	Max.
SCF010-1812	Figure1	4.37	4.73	3.07	3.41	0.60	0.90	0.30	0.95	0.25	0.65
SCF010-1812R	Figure2	4.37	4.73	3.07	3.41	0.60	0.90	0.30	0.95	0.25	0.65
SCF014-1812	Figure1	4.37	4.73	3.07	3.41	0.60	0.90	0.30	0.95	0.25	0.65
SCF014-1812R	Figure2	4.37	4.73	3.07	3.41	0.60	0.90	0.30	0.95	0.25	0.65
SCF020-1812	Figure1	4.37	4.73	3.07	3.41	0.60	0.90	0.30	0.95	0.25	0.65
SCF020-1812R	Figure2	4.37	4.73	3.07	3.41	0.60	0.90	0.30	0.95	0.25	0.65
SCF020-60-1812R	Figure2	4.37	4.73	3.07	3.41	0.60	0.90	0.30	0.95	0.25	0.65
SCF030-1812R	Figure2	4.37	4.73	3.07	3.41	0.40	0.70	0.30	0.95	0.25	0.65
SCF035-1812	Figure1	4.37	4.73	3.07	3.41	0.40	0.70	0.30	0.95	0.25	0.65
SCF035-1812R	Figure2	4.37	4.73	3.07	3.41	0.40	0.70	0.30	0.95	0.25	0.65
SCF035-30-1812R	Figure2	4.37	4.73	3.07	3.41	0.40	0.70	0.30	0.95	0.25	0.65
SCF050-1812	Figure1	4.37	4.73	3.07	3.41	0.35	0.65	0.30	0.95	0.25	0.65
SCF050-1812R	Figure2	4.37	4.73	3.07	3.41	0.35	0.65	0.30	0.95	0.25	0.65
SCF050-30-1812R	Figure2	4.37	4.73	3.07	3.41	0.45	0.75	0.30	0.95	0.25	0.65
SCF075-1812	Figure1	4.37	4.73	3.07	3.41	0.35	0.65	0.30	0.95	0.25	0.65
SCF075-1812R	Figure2	4.37	4.73	3.07	3.41	0.35	0.65	0.30	0.95	0.25	0.65
SCF075-24-1812R	Figure2	4.37	4.73	3.07	3.41	0.80	1.55	0.25	0.95	0.25	0.65
SCF075-33-1812R	Figure2	4.37	4.73	3.07	3.41	0.80	1.55	0.25	0.95	0.25	0.65
SCF110-1812	Figure1	4.37	4.73	3.07	3.41	0.25	0.55	0.30	0.95	0.25	0.65
SCF110-1812R	Figure2	4.37	4.73	3.07	3.41	0.25	0.55	0.30	0.95	0.25	0.65
SCF110-16-1812	Figure1	4.37	4.73	3.07	3.41	0.25	0.90	0.30	0.95	0.25	0.65
SCF110-16-1812R	Figure2	4.37	4.73	3.07	3.41	0.25	0.90	0.30	0.95	0.25	0.65
SCF110-24-1812R	Figure2	4.37	4.73	3.07	3.41	0.80	1.30	0.25	0.95	0.25	0.65
SCF110-33-1812R	Figure2	4.37	4.73	3.07	3.41	0.80	1.30	0.25	0.95	0.25	0.65
SCF125-1812	Figure1	4.37	4.73	3.07	3.41	0.25	0.55	0.30	0.95	0.25	0.65
SCF125-1812R	Figure2	4.37	4.73	3.07	3.41	0.25	0.55	0.30	0.95	0.25	0.65
SCF125-16-1812R	Figure2	4.37	4.73	3.07	3.41	0.50	1.00	0.30	0.95	0.25	0.65
SCF150-1812	Figure1	4.37	4.73	3.07	3.41	0.25	0.55	0.30	0.95	0.25	0.65
SCF150-1812R	Figure2	4.37	4.73	3.07	3.41	0.25	0.55	0.30	0.95	0.25	0.65
SCF150-12-1812R	Figure2	4.37	4.73	3.07	3.41	0.60	1.10	0.25	0.95	0.25	0.65
SCF150-24-1812R	Figure2	4.37	4.73	3.07	3.41	0.60	1.55	0.25	0.95	0.25	0.65
SCF160-1812	Figure1	4.37	4.73	3.07	3.41	0.25	0.90	0.30	0.95	0.25	0.65
SCF160-1812R	Figure2	4.37	4.73	3.07	3.41	0.25	0.90	0.30	0.95	0.25	0.65
SCF160-12-1812R	Figure2	4.37	4.73	3.07	3.41	0.60	1.35	0.25	0.95	0.25	0.65
SCF160-16-1812R	Figure2	4.37	4.73	3.07	3.41	0.60	1.35	0.25	0.95	0.25	0.65
SCF190-1812R	Figure2	4.37	4.73	3.07	3.41	0.30	0.70	0.25	0.95	0.25	0.65

Surface Mount Resettable PTCs

SCF1812 Series

Dimensions (Unit: mm) (Continue)

SCF200-1812R	Figure2	4.37	4.73	3.07	3.41	0.55	1.20	0.25	0.95	0.25	0.65
SCF200-16-1812R	Figure2	4.37	4.73	3.07	3.41	0.60	1.55	0.25	0.95	0.25	0.65
SCF260-1812R	Figure2	4.37	4.73	3.07	3.41	0.55	1.20	0.25	0.95	0.25	0.65
SCF260-13-1812R	Figure2	4.37	4.73	3.07	3.41	0.80	1.55	0.25	0.95	0.25	0.65
SCF260-16-1812R	Figure2	4.37	4.73	3.07	3.41	0.80	1.55	0.25	0.95	0.25	0.65
SCF300-1812R	Figure2	4.37	4.73	3.07	3.41	0.80	1.55	0.25	0.95	0.25	0.65

Packaging

Part Number	Packaging Option	Quantity
SCF010-1812	Tape & Reel -12mm/7"tape	2000
SCF010-1812R	Tape & Reel -12mm/7"tape	2000
SCF014-1812	Tape & Reel -12mm/7"tape	2000
SCF014-1812R	Tape & Reel -12mm/7"tape	2000
SCF020-1812	Tape & Reel -12mm/7"tape	2000
SCF020-1812R	Tape & Reel -12mm/7"tape	2000
SCF020-60-1812R	Tape & Reel -12mm/7"tape	2000
SCF030-1812R	Tape & Reel -12mm/7"tape	2000
SCF035-1812	Tape & Reel -12mm/7"tape	2000
SCF035-1812R	Tape & Reel -12mm/7"tape	2000
SCF035-30-1812R	Tape & Reel -12mm/7"tape	2000
SCF050-1812	Tape & Reel -12mm/7"tape	2000
SCF050-1812R	Tape & Reel -12mm/7"tape	2000
SCF050-30-1812R	Tape & Reel -12mm/7"tape	2000
SCF075-1812	Tape & Reel -12mm/7"tape	2000
SCF075-1812R	Tape & Reel -12mm/7"tape	2000
SCF075-24-1812R	Tape & Reel -12mm/7"tape	1500
SCF075-33-1812R	Tape & Reel -12mm/7"tape	1500
SCF110-1812	Tape & Reel -12mm/7"tape	2000
SCF110-1812R	Tape & Reel -12mm/7"tape	2000
SCF110-16-1812	Tape & Reel -12mm/7"tape	2000

Part Number	Packaging Option	Quantity
SCF110-16-1812R	Tape & Reel -12mm/7"tape	2000
SCF110-24-1812R	Tape & Reel -12mm/7"tape	1500
SCF110-33-1812R	Tape & Reel -12mm/7"tape	1500
SCF125-1812	Tape & Reel -12mm/7"tape	2000
SCF125-1812R	Tape & Reel -12mm/7"tape	2000
SCF125-16-1812R	Tape & Reel -12mm/7"tape	1500
SCF150-1812	Tape & Reel -12mm/7"tape	2000
SCF150-1812R	Tape & Reel -12mm/7"tape	2000
SCF150-12-1812R	Tape & Reel -12mm/7"tape	2000
SCF150-24-1812R	Tape & Reel -12mm/7"tape	2000
SCF160-1812	Tape & Reel -12mm/7"tape	2000
SCF160-1812R	Tape & Reel -12mm/7"tape	2000
SCF160-12-1812R	Tape & Reel -12mm/7"tape	2000
SCF160-16-1812R	Tape & Reel -12mm/7"tape	2000
SCF190-1812R	Tape & Reel -12mm/7"tape	2000
SCF200-1812R	Tape & Reel -12mm/7"tape	2000
SCF200-16-1812R	Tape & Reel -12mm/7"tape	1500
SCF260-1812R	Tape & Reel -12mm/7"tape	2000
SCF260-13-1812R	Tape & Reel -12mm/7"tape	1500
SCF260-16-1812R	Tape & Reel -12mm/7"tape	1500
SCF300-1812R	Tape & Reel -12mm/7"tape	1500

Surface Mount Resettable PTCs

SCF1812 Series

Tape and Reel Specifications

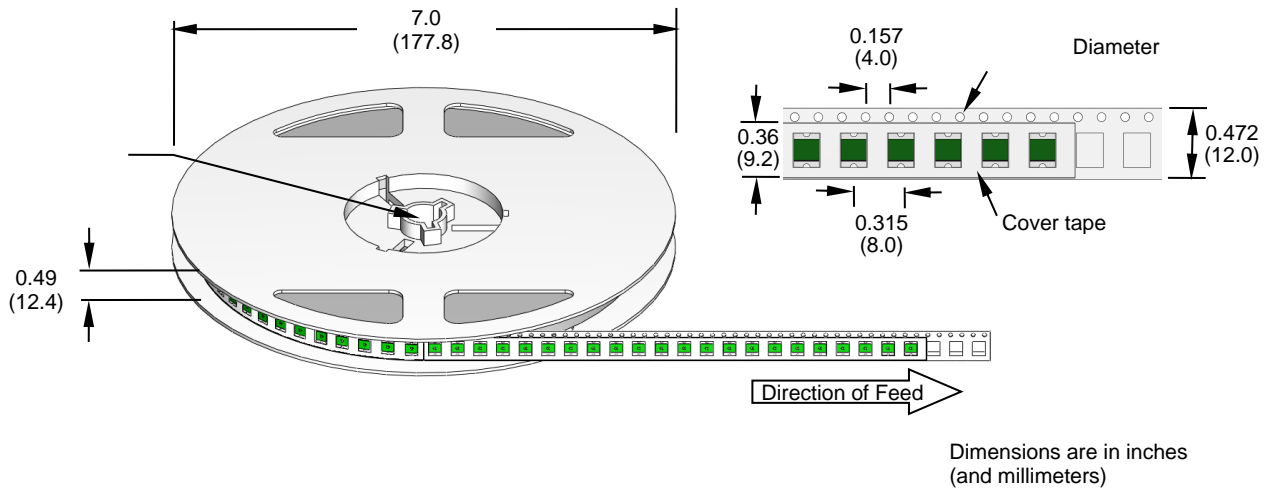

Warning



- ⌌ Operation beyond the specified maximum ratings or improper use may result in damage and possible electrical arcing and/or flame.
- ⌌ PPTC device are intended for occasional over-current protection. Application for repeated over-current condition and/or prolonged trip are not anticipated.
- ⌌ Avoid contact of PPTC device with chemical solvent. Prolonged contact will damage the device performance.