

皓宇（香港）公司 HAOYU (HONG KONG) LIMITED	产品规格书 <b>Product</b>	文件编号 Doc. No.	SPEC-USB-001
		版本 Rev.	A
		页次 Sheet	1/7

### 1. 范围 Scope

该标准涵盖皓宇（香港）公司制造中心生产的USB C TYPE连接器之功能要求及测试方法。

This specification covers the requirements for product performance and test methods of HAOYU (HONG KONG) LIMITED Manufacturing Center's USB C TYPE plug and receptacle Connectors.

### 2. 标准文件 Related Standards

- 2-1 IEC512
- 2-2 MIL-STD 202
- 2-3 EIA-364

### 3. 等级 Rating

- 3-1 额定: 3A 30V AC/DC max  
Rated : 3A 30V AC/DC max
- 3-2 温度范围: 存储: -20°C + 60°C  
Temperature Range: storage : -20°C to +60°C ;  
工作: -30°C + 80°C ;  
operating : -30°C to +80°C ;  
名义: : +20°C  
Nominal : +20°C

### 4. 测试要求 Test Condition

- 4-1 所有的测试应当执行详见下表条件,除非另有说明。  
All tests shall be performed as bellow conditions unless otherwise specified.
- 4-2 温度范围: +15°C + 35°C  
Temperature range : +15°C to +35°C
- 4-3 湿度范围: 25% - 85%  
Humidity range: 25% to 85%

皓宇（香港）公司 HAOYU (HONG KONG) LIMITED	产品规格书 Product	文件编号 Doc. No.	SPEC-USB-001
		版本 Rev.	A
		页次 Sheet	2/7

## 5. 产品外观 PRODUCT APPEARANCE

项目 ITEM	描述 Description	测试方法 Test Methods	测试规格 Test Specification
5-1	产品外观 Examination of Product Appearance	依据 EIA364-18 测试 肉眼观察， 产品外形必须符合图纸要求。	产品外观良好，无外观不良情形， 产品结构及尺寸须符合图纸设计 要求。
		EIA364-18 Shall be confirmed with eyes in accordance with each drawing.	Outward appearance shall be good without such injurious problem and structure shall be meet the design and dimension requirement of drawing

## 6. 机械性能 MECHANICAL PERFORMANCE

项目 ITEM	描述 Description	测试方法 Test Methods	测试规格 Test Specification
6-1	插入力 Insertion force	依据 EIA 364-13 测试方式 ,操作速 度 12.5mm /min.	插拔力的范围: 5N-20 N
		EIA 364-13 Measure force at maximum rate of 12.5mm (0.492") per minute	The connector insertion force shall be the range from 5N to 20N
6-2	拔出力 Extraction force	依据EIA 364-13测试方式 , 测量力 的速度达到最大12.5 mm /min.	拔出力的范围: 8N-20 N
		EIA 364-13 Measure force at maximum rate of 12.5mm(0.492") per minute	The connector extraction force shall be the range from 8N to 20N
6-3	耐插拔 Durability	依据EIA 364-09测试方式 插拔10000次循环,手动插拔速度 200周期/小时.	必须满足以下条件后循环测试完成后: 接触电阻(40 mΩ,变化量10 mΩ(Max)后 测试) 插入力(5到20N) 拔出力(8到20 N) 产品外观符合需求, 无破损及外形损伤。

<p>皓宇（香港）公司 HAOYU (HONG KONG) LIMITED</p>		<p>产品规格书 Product</p>		<p>文件编号 Doc. No.</p>	<p>SPEC-USB-001</p>
				<p>版本 Rev.</p>	<p>A</p>
				<p>页次 Sheet</p>	<p>3/7</p>
		<p>EIA 364-09 Type C :10000 cycles cycle rate of 200cycles per hour manually。</p>	<p>Must meet the following criteria after the cycle test is completed: - Contact resistance (40mΩ , delta 10mΩ(Max) after test) - Insertion force (5N to 20N) - Extraction force (8N to 20N) - Visual inspection (no exposed base metal on contacts)</p>		
<p>6-4</p>	<p>Cable 摇摆弯曲 Cable Flexing</p>	<p>依据 EIA 364-41 测试方式 电缆组件与尺寸 X =电缆外径 3.7, 并在两个平面 120 度来回 100 个循环。</p>	<p>弯曲过程中没有物理损坏或不连续 1ms 以上应发生在</p>		
		<p>EIA 364-41 100 cycles in each of 2 planes 120 degree. Dimension x=3.7x cable diameter</p>	<p>No discontinuity over 1 microsecond During flexing or physical damage allowed</p>		
<p>6-5</p>	<p>Cable 负重测试 Cable Pull-Out</p>	<p>依据 EIA-364-38 测试方式 经受 40 N 轴向负荷为最小为 1 分钟</p>	<p>组件没有损伤和物理损坏</p>		
		<p>EIA-364-38 40N steady state axial load for 1 minute</p>	<p>No discontinuity or physical damage allowed</p>		
<p>6-6</p>	<p>四轴向测试 4-axes continuity test</p>	<p>8N 拉力一段 10 秒钟;标本必须服从 0°、90°、180°、270°四个方向。</p>	<p>组件没有间断大于 1us,没有物理损害</p>		
		<p>8N tensile force for a period of 10 seconds Min; The specimen must subject to 0° , 90° , 180° , 270° direction.</p>	<p>No discontinuity greater than 1us and no physical damage to the specimen(one cable per test)</p>		
		<p>EIA364-18 105° C without applied voltage for 120 hours. 105° C without applied voltage for 72 hours when used as preconditioning in EIA 364-1000. 01</p>	<p>Visual inspection,Test shall be done in sequences defined in EIA364-1000.01</p>		

皓宇（香港）公司 HAOYU (HONG KONG) LIMITED	产品规格书 Product	文件编号 Doc. No.	SPEC-USB-001
		版本 Rev.	A
		页次 Sheet	4/7

## 7. 电气特性 ELECTRICAL PERFORMANCE

项目 ITEM	描述 Description	测试方法 Test Methods	测试规格 Test Specification
7-1	绝缘阻抗 Insulation Resistance	依据 <b>EIA 364-21C</b> 测试方式 加100V DC的电压于相邻两端子之 间.	未交配和配对连接相邻触点间最低 100MΩ 绝缘电阻
		<b>EIA 364-21C</b> Unmated connectors, apply 100Volts DC between adjacent terminal or ground.	100MΩminimum(unmated)between adjacent contacts and contacts and shell
7-2	低电接触电阻 Low Level Contact Resistance	依据 <b>EIA 364-23b</b> 测试方式 一组对插好的连接器; 测试开路电压:20mV max.; 测试短路电流: 100m A max..	接触电阻(40 mΩ,测试后变化量10 mΩ(Max))
		<b>EIA 364-23b</b> 20mV Max. open circuit at 100mA Max.	40mΩ(Max) initial for VBUS and GND contacts and all other contacts; delta 10mΩ(Max) after test
7-3	耐电压 Dielectric withstanding Voltage	依据 <b>EIA 364-20</b> 测试方式 加100V AC的电压于相邻两端子之间 1分钟.	无击穿和飞弧现象
		<b>EIA 364-20</b> Subjected to 100VAC (RMS) for 1 minute between adjacent terminals.	There shall be no breakdown
7-4	接触额定电流 Contact current rating	5.0 A的电流应被共同施加到VBUS引 脚和1.25 A通过相应的GND施加到 VCONN引脚与返回路径引脚。 0.25 A的最小电流也应分别适用于所有的 其它端子。	当电流被施加到触点上，温度上升不 超过30℃的USB型-C下测试，当在25 ℃的环境温度下测得的配套插头和插 座的任何点
		<b>EIA364-70</b> 5.0A shall be applied collectively to VBUS pins and 1.25 A applied to the VCONN pin and 0.25 A the other contacts.	When the currents are applied to the contacts, the temperature rise shall not exceed 30 °C at any point on the USB Type-C mated plug and receptacle under test, when measured at an ambient temperature of 25 °C.

皓宇（香港）公司 HAOYU (HONG KONG) LIMITED	产品规格书 Product	文件编号 Doc. No.	SPEC-USB-001
		版本 Rev.	A
		页次 Sheet	5/7

## 8. 环境特性 ENVIRONMENT PERFORMANCE

项目 ITEM	描述 Description	测试方法 Test Methods	测试规格 Test Specification
8-1	温度老化测试 Temperature Life	依据EIA 364-17测试方式 温度寿命试验的温度和持续时间 105℃下 120 小时 温度寿命试验的温度和持续时间对预处理 105℃， 72 小时	外观: 无损伤; 试验后接触电阻最大: 40mΩ
		<b>EIA 364-17</b> 105° C without applied voltage for 120 hours. 105° C without applied voltage for 72 hours when used as preconditioning in EIA 364-1000.01.	Visual inspection, Test shall be done in sequences defined in EIA 364-1000.01.
8-2	冷热冲击测试 Thermal Shock	依据EIA 364-32方式测试 10 个周期-55℃+ -55℃。USB 3.0 必须对插配合下 测试	外观没有损害
		<b>EIA 364-32</b> 10 Cycles - 55°C and +85°C. The USB 3.0 connectors under test must be mated.	There shall be no evidence of any physical damage.
8-3	盐水喷雾 Salt Spray	MIL-STD-202F 101d 条件B测试 对插产品测试环境: 温度: 35±2℃, 盐 水浓度:重量比5±1%, 时间: 48小时。 测试后常温水洗,干燥.	1) 要满足视觉要求, 没有物理 损害。 2) 要满足的要求, 额外的测试 中指定在第五节测
		MIL-STD-202F, Method 101D, Test Condition B Subject mated connectors to 48 hours at 35 °C with 5%-Salt-solution concentration.	1).Shall meet visual requirement, show no physical damage. 2).Shall meet requirements of additional tests as specified in test sequence in Section 5
	恒温恒湿	依据 EIA 364-31方式测试 周期 25℃± 3℃之间对插产品在 80%± 3% 湿度 和 65℃± 3℃温度 50%± 3% 湿度,时间应 0.5 小 时和停顿时间 0.5 小时。24 个周期	目视检查,测试应在序列中定义 完成 EIA 364 - 1000.01

皓宇（香港）公司 HAOYU (HONG KONG) LIMITED	产品规格书 <b>Product</b>	文件编号 Doc. No.	SPEC-USB-001
		版本 Rev.	A
		页次 Sheet	1/7

### 1. 范围 Scope

该标准涵盖皓宇（香港）公司制造中心生产的USB C TYPE连接器之功能要求及测试方法。

This specification covers the requirements for product performance and test methods of HAOYU (HONG KONG) LIMITED Manufacturing Center's USB C TYPE plug and receptacle Connectors.

### 2. 标准文件 Related Standards

- 2-1 IEC512
- 2-2 MIL-STD 202
- 2-3 EIA-364

### 3. 等级 Rating

- 3-1 额定: 3A 30V AC/DC max  
Rated : 3A 30V AC/DC max
- 3-2 温度范围: 存储: -20°C + 60°C  
Temperature Range: storage : -20°C to +60°C ;  
工作: -30°C + 80°C ;  
operating : -30°C to +80°C ;  
名义: : +20°C  
Nominal : +20°C

### 4. 测试要求 Test Condition

- 4-1 所有的测试应当执行详见下表条件,除非另有说明。  
All tests shall be performed as bellow conditions unless otherwise specified.
- 4-2 温度范围: +15°C + 35°C  
Temperature range : +15°C to +35°C
- 4-3 湿度范围: 25% - 85%  
Humidity range: 25% to 85%



5 · DURABILITY (耐久性)

5A	<p>RESISTANCE TO SOLDERING HEAT TEST 耐焊性試驗</p>	<p>THE TOP OF THE TERMINALS SHALL BEDIPPED 2mm . THE PLASTIC BODY IS 1.6mm ABOVE THE TIN LIGUID. 端子頂部被浸入焊錫池中 2mm 深, 膠身距離錫液 1.6mm。 Wave-soldering is to be performed within 3seconds at 260 +/-5 °C 波峰焊接溫度 260 +/-5°C 時間 3 秒。 Hand weilding to be performed within 3 seconds at 380°C or below. 手工焊接溫度為 380°C或以內, 時間為 3±0.5 秒。 Reflow welding to be performed within 3 seconds at 260°C or below. 回流焊接溫度為 260°C或以內, 時間為 3±0.5 秒 注: 本產品只適合用手焊、波峰焊、回流焊。</p>	<p>WITHOUT DEFORMATION OF CASE OR EXCESSIVE LOOSENESS OF TERMINALS ELECTRICAL CHARACTERISTICS SHALL BE SATISFIED. 本體無變形, 能滿足於機械、電氣性 能。</p>
----	----------------------------------------------------------------	----------------------------------------------------------------------------------------------------------------------------------------------------------------------------------------------------------------------------------------------------------------------------------------------------------------------------------------------------------------------------------------------------------------------------------------------------------------------------------------------	--------------------------------------------------------------------------------------------------------------------------------------------------------------------



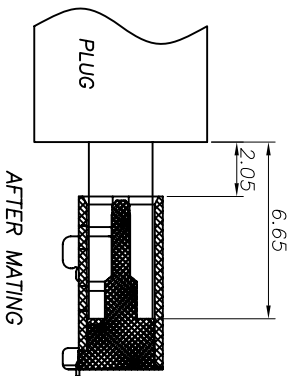
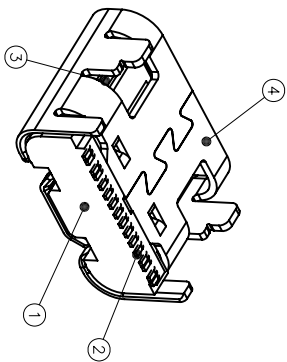
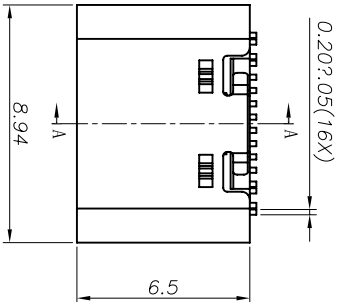

A1	GND	B12	GND
A2	SSTXP1	B11	SSRXN1
A3	SSTXN1	B10	SSRXN1
A4	VBUS	B9	VBUS
A5	CC1	B8	SBUS2
A6	DP1	B7	DN2
A7	DN1	B6	DP2
A8	SBUS1	B5	CC2
A9	VBUS	B4	VBUS
A10	SSRXN2	B3	SSTXN2
A11	SSRXP2	B2	SSTXP2
A12	GND	B1	GND

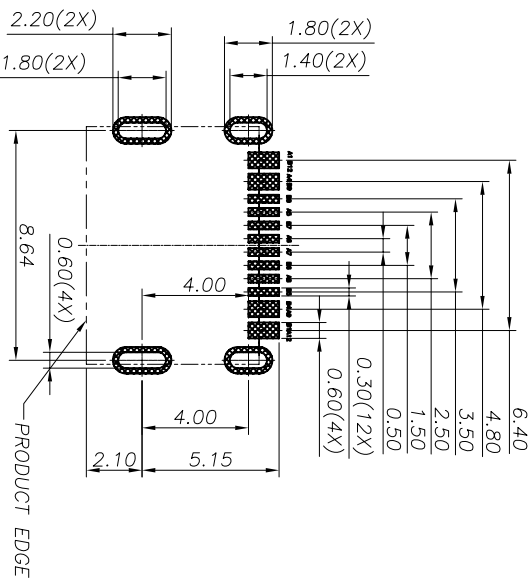
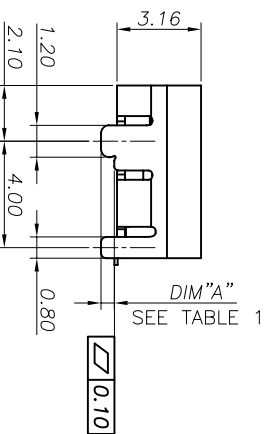
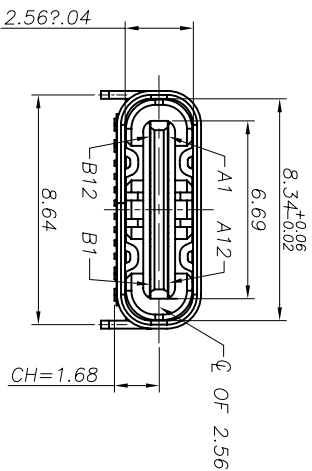

RECOMMENDED PCB LAYOUT(TOP VIEW)  
THICKNESS: 0.60MM;DEFAULT TOLERANCE:±0.05

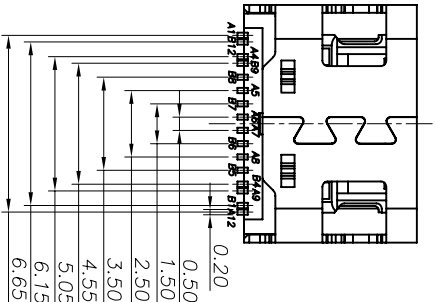

SECTION:A-A

TOLERANCE UNLESS SPECIFIED		ANGULAR	NO	DATE	REVISIONS	BY	APPD
UP TO 5mm: ±0.1		±1°	1				
ABOVE 5mm: ±0.2							

NO.	PART	NAME	MATERIAL	QTY	FINISHING
5					
4	SHELL		SUS	1	Ni-PLATED
3	MID PLATE		SUS	1	Ni-PLATED
2	CONTACT		BRASS	12	Au/Ni-PLATED
1	HOUSING		LCP	1	

TITLE: USB JACK	UNIT: MM	ROHS COMPLIANT	DWN	BY	APPD
MODEL: USB-310P-B-SU	SCALE: 1:1				



HAOYU(HONGKONG)LIMITED  
皓宇(香港)有限公司

PRO.AGL: REV: A0