



SS2020FL~SS20100FL

SURFACE MOUNT SCHOTTKY BARRIER RECTIFIER

VOLTAGE 20 to 100 Volt **CURRENT** 2 Ampere

SOD-123FL Unit : inch(mm)

FEATURES

- Fast switching speed
- Surface mount package ideally suited for automatic insertion
- Low power loss, high efficiency
- Ultra thin profile package for space constrained utilization
- Lead free in compliance with EU RoHS 2.0
- Green molding compound as per IEC 61249 standard

MECHANICAL DATA

- Case : SOD-123FL, Plastic
- Terminals : Solderable per MIL-STD-750, Method 2026
- Approx. Weight : 0.0006 ounces, 0.017 grams.
- Polarity : Color band denotes cathode end

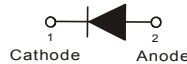
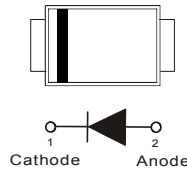

ABSOLUTE RATINGS

PARAMETER	SYMBOL	SS2020FL	SS2030FL	SS2040FL	SS2060FL	SS20100FL	UNITS	
Marking Code		GM	GN	GP	GQ	GR		
Reverse Voltage	V_R	20	30	40	60	100	V	
Peak Reversr Voltage	V_{RRM}	20	30	40	60	100	V	
Average Rectified Current at $T_A=75^\circ\text{C}$	$I_{F(AV)}$	2						A
Non-repetitive Peak Forward Surge Current at $t=8.3\text{ms}$	I_{FSM}	50						A

ELECTRICAL AND THERMAL CHARACTERISTICS

PARAMETER	SYMBOL	SS2020FL	SS2030FL	SS2040FL	SS2060FL	SS20100FL	UNITS
Minimum Reverse Breakdown Voltage at $I_R=500\mu\text{A}$	V_R	20	30	40	60	100	V
Maximum Forward Voltage at $I_F=2\text{A}$	V_F	0.5			0.7	0.85	V
Reverse Leakage Current at V_{RRM}	I_R	100			40		μA
Typical Thermal Resistance, Junction to Ambient	$R_{\theta JA}$	60					$^\circ\text{C/W}$
Operating Junction and Storage Temperature Range	T_J, T_{STG}	-50 to +150					$^\circ\text{C}$

Note:1 Mounted with minimum recommended pad size, PC Board FR4.
2. $T_A=25^\circ\text{C}$ unless otherwise specified.



SS2020FL~SS20100FL

Rating and Characteristic Curves

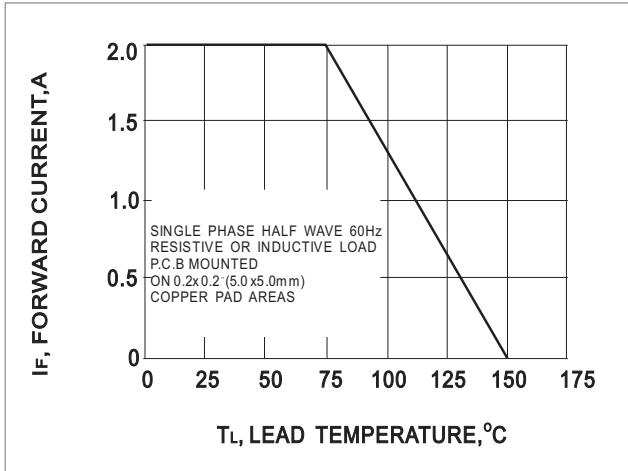

FIG. 1 FORWARD CURRENT DERATING CURVE

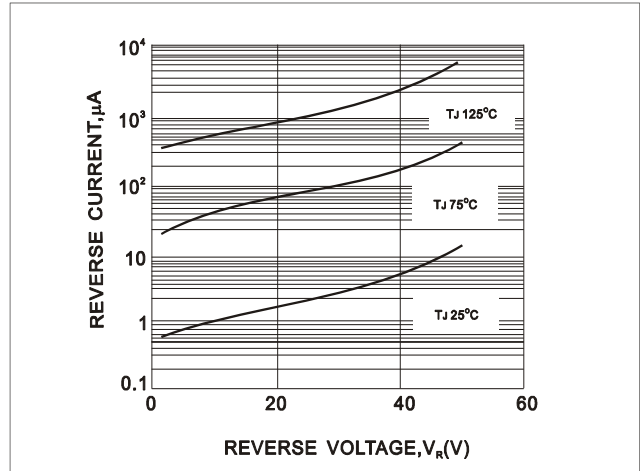

FIG. 2 TYPICAL REVERSE CHARACTERISTIC

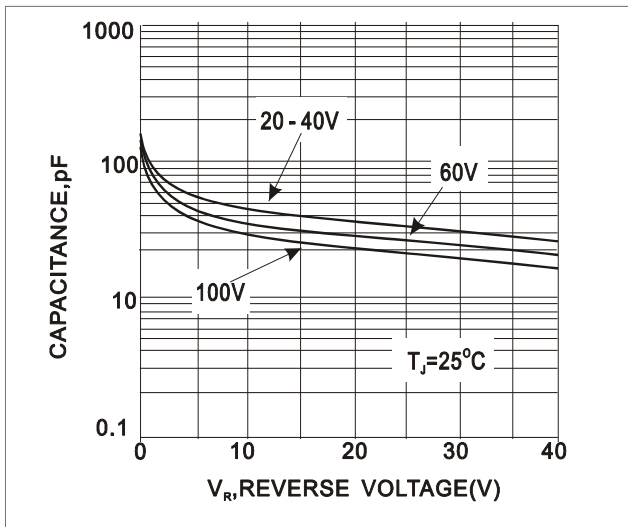

FIG. 3 TYPICAL JUNCTION CHARACTERISTIC

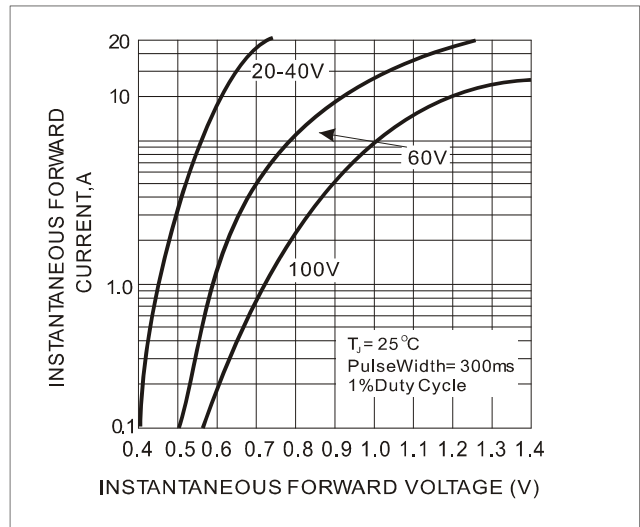

FIG. 4 TYPICAL INSTANTANEOUS FORWARD CHARACTERISTICS

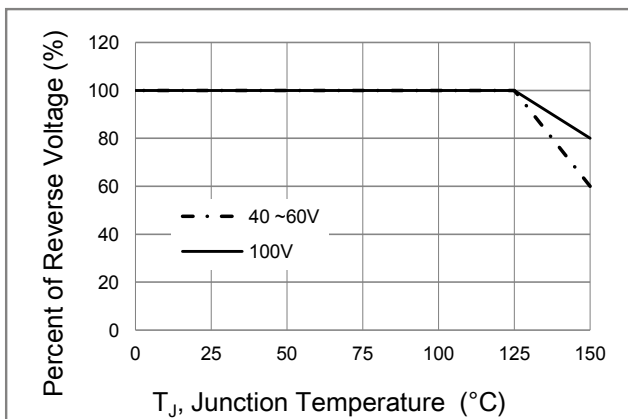
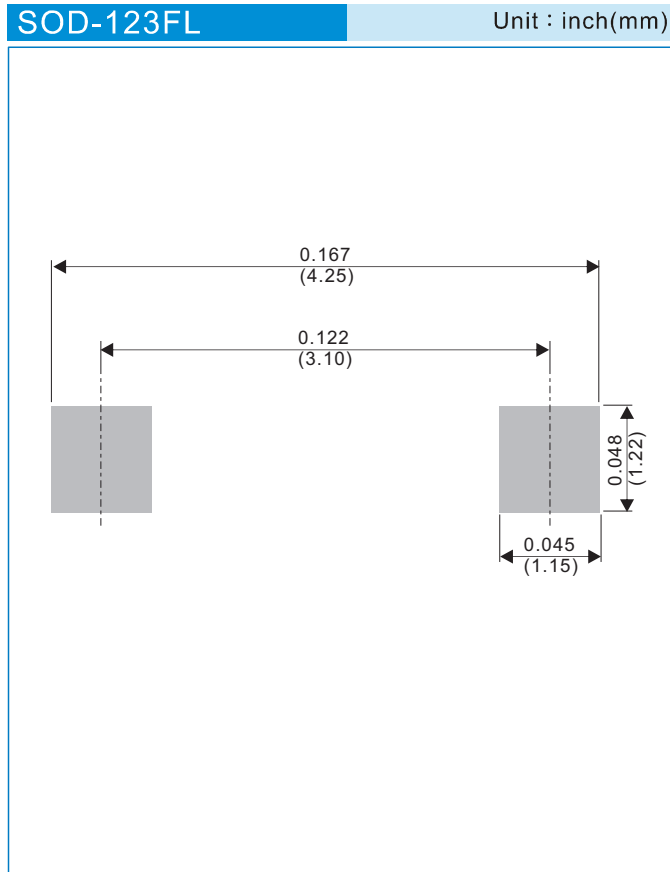

Fig.5 Operating Temperature Derating Curve



SS2020FL~SS20100FL

MOUNTING PAD LAYOUT



ORDER INFORMATION

- Packing information
T/R - 10K per 13" plastic Reel
T/R - 3K per 7" plastic Reel



SS2020FL~SS20100FL

Part No_packing code_Version

SS2020FL_R1_00001

SS2020FL_R2_00001

For example :

RB500V-40_R2_00001

Part No.

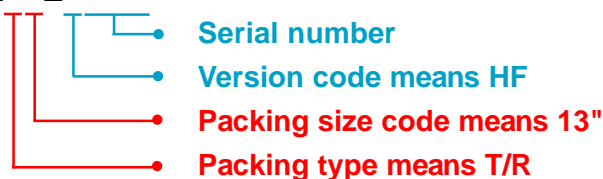

Packing Code XX				Version Code XXXXX		
Packing type	1 st Code	Packing size code	2 nd Code	HF or RoHS	1 st Code	2 nd ~5 th Code
Tape and Ammunition Box (T/B)	A	N/A	0	HF	0	serial number
Tape and Reel (T/R)	R	7"	1	RoHS	1	serial number
Bulk Packing (B/P)	B	13"	2			
Tube Packing (T/P)	T	26mm	X			
Tape and Reel (Right Oriented) (TRR)	S	52mm	Y			
Tape and Reel (Left Oriented) (TRL)	L	PANASERT T/B CATHODE UP (PBCU)	U			
FORMING	F	PANASERT T/B CATHODE DOWN (PBCD)	D			



SS2020FL~SS20100FL

Disclaimer

- Reproducing and modifying information of the document is prohibited without permission from Panjit International Inc..
- Panjit International Inc. reserves the rights to make changes of the content herein the document anytime without notification. Please refer to our website for the latest document.
- Panjit International Inc. disclaims any and all liability arising out of the application or use of any product including damages incidentally and consequentially occurred.
- Panjit International Inc. does not assume any and all implied warranties, including warranties of fitness for particular purpose, non-infringement and merchantability.
- Applications shown on the herein document are examples of standard use and operation. Customers are responsible in comprehending the suitable use in particular applications. Panjit International Inc. makes no representation or warranty that such applications will be suitable for the specified use without further testing or modification.
- The products shown herein are not designed and authorized for equipments requiring high level of reliability or relating to human life and for any applications concerning life-saving or life-sustaining, such as medical instruments, transportation equipment, aerospace machinery et cetera. Customers using or selling these products for use in such applications do so at their own risk and agree to fully indemnify Panjit International Inc. for any damages resulting from such improper use or sale.
- Since Panjit uses lot number as the tracking base, please provide the lot number for tracking when complaining.