

**汕头市鸿志企业有限公司**

地址: 汕头市天山路成德工业村C座

Shantou HongZhi Enterprises Ltd.

Build C, Chengde Industrial area, Tianshan Rd, Shantou

TEL: 0754-88788046 FAX: 0754-88784178 Mail: hongzhi@hongzhi.net

**企业成员 ENTERPRISE MEMBERS**

**汕头市鸿志电子有限公司**

地址: 广东省汕头市龙湖区浦江路6号(电容事业部)

地址: 广东省汕头市龙湖区庐山路39号(敏感元件事业部)

Shantou Hong Zhi Electronics Co., Ltd.

No.6 Pujiang Rd, Longhu district, Shantou City, Guangdong Province, China

No. 39, Mount Lu Road, Longhu District, Guangdong District, Shantou Province

TEL: 0754-88784177 FAX: 0754-88888417 Mail: lnxi@hongzhi.net

**香港鸿志电子有限公司**

地址: 香港九龙湾宏冠道6号鸿力工业中心B座六楼612室

Hong Zhi Electronics Co., Ltd.

Room 612, 6f, b Block of HongLi Industrial Building, HongGuan Road, Kowloon Bay, HongKong.

**揭阳空港经济区弘新电子有限公司**

地址: 广东省揭阳空港经济区地都镇蛟龙村蛤坞东侧(金龙工业区)

Hongxin Electronics Co., Ltd.

Jinlong Industrial area, Jiaolong village Didu town, Jieyang City, China

**宁波市舒雷电子有限公司**

地址: 浙江省宁波市姜山镇朝阳路37号

Ningbo Shulei Electronics Co., Ltd.

No.37 Chaoyang Rd, Jiangshan town, NingBo City, Zhejiang province, China.

TEL: 0574-88093028 FAX: 0574-88093026 Mail: guozhiyongs@163.com

# NTC热敏电阻



## NTC THERMISTOR

**HEL® 汕头市鸿志电子有限公司**  
SHANTOU HONGZHI ELECTRONICS CO., LTD.

地址: 广东省汕头市龙湖区庐山路39号

No.39 Lushan Rd, Longhu district, Shantou City, Guangdong Province, China

TEL: 0754-88784177

+86-754-88831426-0

FAX: 0754-88888417

+86-754-88888417

Mobile: 13923676782

+86-013923995840

Website: www.varistor.cn

www.hongzhi.net

Mail: hel@varistor.cn

lnxi@hongzhi.net



**汕头市鸿志电子有限公司**  
SHANTOU HONGZHI ELECTRONICS CO., LTD.

**揭阳空港经济区弘新电子有限公司**  
JIEYANG HONGXIN ELECTRONICS CO., LTD.



# 合作共赢 成就一番天地

WIN-WIN COOPERATION ACHIEVEMENT HEAVEN AND EARTH

以人才和技术为核心 · 创造一流的产品和服务



公司概况 Company Profile .....	01
公司发展历程 Company Developing Process .....	02
NTC热敏电阻资质认证 Quality Certification .....	04
<b>MF72 功率型热敏电阻 MF72 Power NTC Thermistor</b> .....	<b>05</b>
应用领域 Application Fields .....	06
特性与功能介绍 Characteristics & Function Introduction .....	06
<b>MF72 订货型号说明 MF72 HOW TO ORDER</b> .....	<b>07</b>
HEL□D-5系列 HEL MF72 Power NTC Thermistor with 5mm Diameter .....	09
HEL□D-7系列 HEL MF72 Power NTC Thermistor with 7mm Diameter .....	10
HEL□D-9系列 HEL MF72 Power NTC Thermistor with 9mm Diameter .....	11
HEL□D-11系列 HEL MF72 Power NTC Thermistor with 11mm Diameter .....	12
HEL□D-13系列 HEL MF72 Power NTC Thermistor with 13mm Diameter .....	13
HEL□D-15系列 HEL MF72 Power NTC Thermistor with 15mm Diameter .....	14
HEL□D-20系列 HEL MF72 Power NTC Thermistor with 20mm Diamete .....	15
<b>MF72 功率型热敏电阻包装方式 MF72 Power NTC Thermistor Packing method</b> .....	<b>16</b>
<b>MF72 技术术语及可靠性试验 MF72 Technical Terminology &amp; Reliability Test</b> .....	<b>18</b>
<b>MF11 温补型热敏电阻 MF11 Thermosensitive Resistance Product Introduction</b> .....	<b>23</b>
<b>NTC 温度传感器 NTC Temperature Sensor</b> .....	<b>25</b>
MF52珠状测温型 MF52 Bead Type Temperature Sensitive Resistor Product Introduction .....	26
MF58玻壳测温型 MF58 Glass Shell Temperature Measuring .....	29
CWF 精密型温度传感器 Pearl-Shape Precision NTC Thermistor .....	30
温度传感器阻温特性表 Temperature Characteristic Meter for Temperature Sensor Resistance .....	31
<b>注意事项 Precautions</b> .....	<b>33</b>
<b>附录 Appendix</b> .....	<b>35</b>



## 公司概况

COMPANY  
PROFILE

汕头市鸿志企业有限公司成立于1993年，位于美丽的海滨城市汕头，现已发展成为元器件制造集团企业，生产压敏电阻、NTC热敏电阻、高中低压瓷介电容和金属化薄膜电容，通过了ISO9001质量体系认证和ISO14001环境体系认证。我司是中国电子学会电压敏专业学部主任委员单位，主导产品压敏电阻和NTC热敏电阻生产规模居国内同行前列。公司产品已经获得VDE、UL、CQC、CSA、TUV、F1、N、D、S等安规认证。产品被广泛应用在IT、通讯、照明、家电、电源、工业设备等领域。真诚期待与您合作，发展鸿图大业！

集团企业成员：

汕头市鸿志企业有限公司

汕头市鸿志电子有限公司

香港鸿志电子有限公司

揭阳空港经济区弘新电子有限公司

宁波市舒雷电子有限公司

HongZhi Electronics Co., Ltd. locating in a coastal city named Shantou since 1993, has been specializing in manufacturing Varistor, NTC Thermistor, Ceramic capacitor, Y type capacitor (Safety Standard recognized ceramic capacitor), Metallized film capacitor. Our company passed the ISO9001 Quality certificate and ISO14001 Environment Certificate. As a director unit of Varistor division in charge of the China Varistor Technology Commission, we develop into a main manufacturer of varistor and NTC Thermistor, and our products have been approved by VDE, UL, CQC, CSA, TUV, F1, N, D, S Safety Certification, they have been widely used in IT, communication, lighting, home appliances, industrial equipment and other fields. Now most of the products are exporting to America, Europe, Asia, Africa etc. Sincerely look forward to establishing a win-win cooperation with you!

Group :

Shantou HongZhi Enterprises Ltd.

Shantou HongZhi Electronics Co.,Ltd.

Hong Zhi Electronics Co.,Ltd.

Jieyang Hongxin Electronics Co.,Ltd.

Ningbo Shulei Electronics Co.,Ltd.





❖ 产品展示 Product display

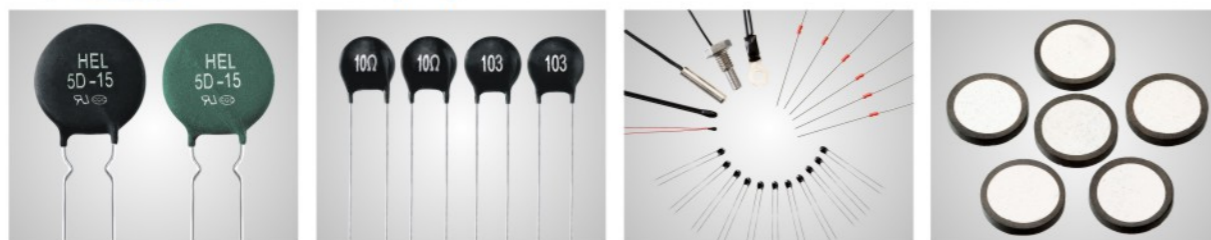

MF72功率型  
MF72 POWER NTC THERMISTOR

MF11温补型  
MF11 TEMPERATURE  
COMPENSATION  
TYPE NTC THERMISTOR

NTC温度传感器  
NTC TEMPERATURE SENSOR

MF72功率型芯片  
MF72 POWER CHIP

❖ 生产一线 Workshop

车间一角 A corner of workshop



❖ 品质保证 Workshop

可靠性实验室 Reliable laboratory



❖ 资质认证 Quality Certification



ISO9001:2015



ISO14001:2015



File NO.CQC10001052520  
China中国CQC认证



GER德国TUV认证



File NO.E319959  
U.S.A美国UL认证



File NO.E319959  
U.S.A美国CUL认证

❖ 认证证书 Certificate Of Authentication



❖ 荣誉证书 Certificate Of Honor







## MF72 功率型热敏电阻

### MF72 POWER NTC THERMISTOR

#### 产品简介 PRODUCTS BRIEF INTRODUCTION

MF72功率型热敏电阻器：为有效抑制电子电路在开机上电的瞬间产生的浪涌电流，在电源电路中串联一个功率型NTC热敏电阻器，能有效地抑制开机时的浪涌电流，并且在完成抑制浪涌电流作用后，由于通过其电流的持续作用，功率型NTC热敏电阻器的电阻值将下降到非常小的程度，它自身消耗的功率可以忽略不计，所以，在电源回路中串联功率型NTC热敏电阻器，是抑制开机浪涌电流保护电子设备免遭破坏的最为简便而有效的措施。MF72为功率型热敏电阻的国标型号。

我司MF72功率型热敏电阻通过了UL、CUL、CQC、TUV认证。

The MF72 Power NTC Thermistor provide inrush current suppression for sensitive electronics. Connecting a NTC Thermistor in series with the power source will limit the current surges typically created at turn on. Once the circuit is energized the resistance of the NTC thermistor will decrease rapidly to a very low value, power consumption can be ignored and there will be no effect on normal operating current. Using the MF72 Power NTC Thermistor is a most cost-effective way to curb surge current and protect sensitive electronics from damage. MF72 for power type thermal resistance GB models.

MF72 Power NTC thermistor acquired the UL CUL CQC and TUV certification.

#### 应用范围和特点 APPLICATION RANGE AND CHARACTERISTICS

##### 应用范围 Appliaction

- 转换电源，开关电源，UPS电源
- 镇流器及各类加热器
- 各类显像管，显示器
- 电子节能灯，其它照明灯具
- Switching power-supply, switch power,ups power
- Electronic energy saving lamps,electronic ballast and all kinds of electric heater
- All kinds of RT ,display
- Bulb and other lighting lamps

##### 特点 Characteristic

- 体积小，功率大，抑制浪涌电流能力强
- 反应速度快
- 材料常数（B值）大，残余电阻小
- 寿命长，可靠性高
- 系列全，应用范围广
- Small size, large power, strong capacity of suppression of inrush current
- Fast response
- Big material constant (B value), small residual resistance
- Long life and high reliability
- Complete series, wide applications

#### 功率型NTC热敏电阻器在电路中抑制浪涌电流示意图

#### SKETCH MAP OF SURGE CURRENT PROTECTION IN CIRCUIT OF POWER NTC THERMISTOR

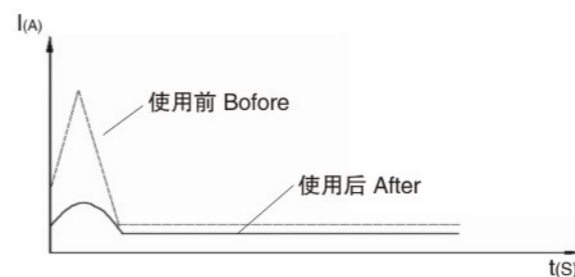

#### MF72功率型热敏电阻之特性

#### CHARACTERISTICS OF MF72 POWER TYPE THERMISTORS

MF72功率型热敏电阻的参数，通常由下列三种基本特性决定：

电阻-温度特性	电压-电流特性	温度-时间特性
<p>当MF72功率型热敏电阻之环境温度或它本身的温度上升时，电阻值随之减小。</p> <p>When the ambient temperature of the MF72 power type thermistor is applied, orAs its temperature rises, the resistance decreases.</p>	<p>当MF72功率热敏电阻在小电流下工作时，由于功率太低，其电阻值保持固定而表现线性(符合欧姆定律V/R=I)。如果电流增加，MF72功率型热敏电阻就会产生焦耳效应(P=V*I)而使自己发热，其电阻随即减小表现(电流增加，电压下降)的状态。</p> <p>When the MF72 power thermistor works at small current When the power is too low, the resistance is kept constant And behave linearly (in accordance with Ohm's law, V/R=I). IfAs the current increases, the MF72 power type thermistor willProduce a Joule effect (P=V*I) and makes itself hotThe resistance then decreases (current increases, voltage decreases)State.</p>	<p>MF72功率型热敏电阻与环境达成热平衡所需的时间，主要决定于材料热容量(H)及散热系数(δ)。</p> <p>The MF72 power type thermistor achieves heat with the environmentThe time required for the equilibrium is mainly determined by the heat of the materialCapacity (H) and heat transfer coefficient (delta).</p>



MF72规格型号说明 MF72 HOW TO ORDER

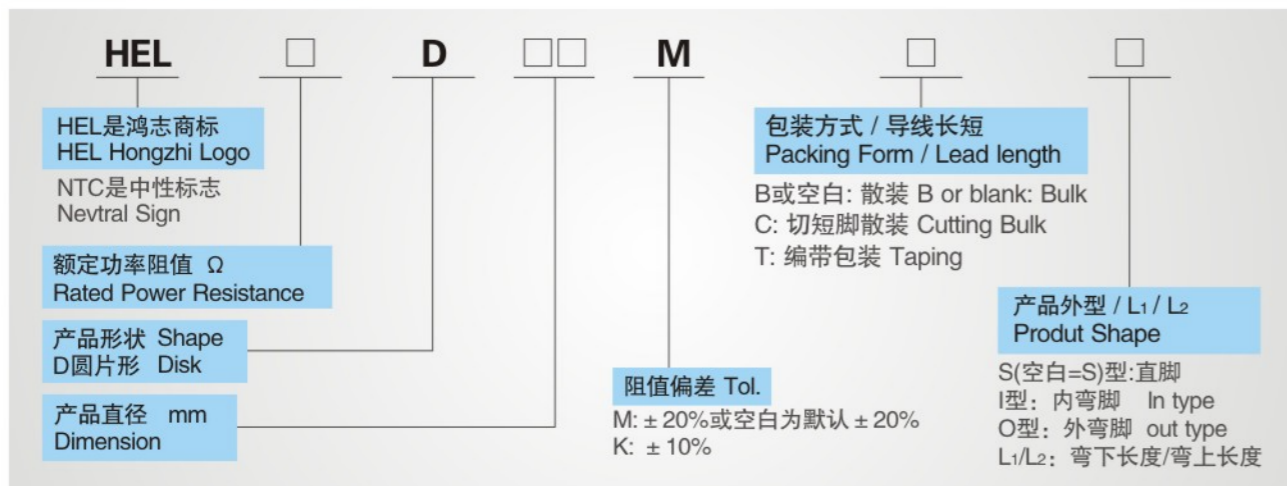

外形 APPEARANCE

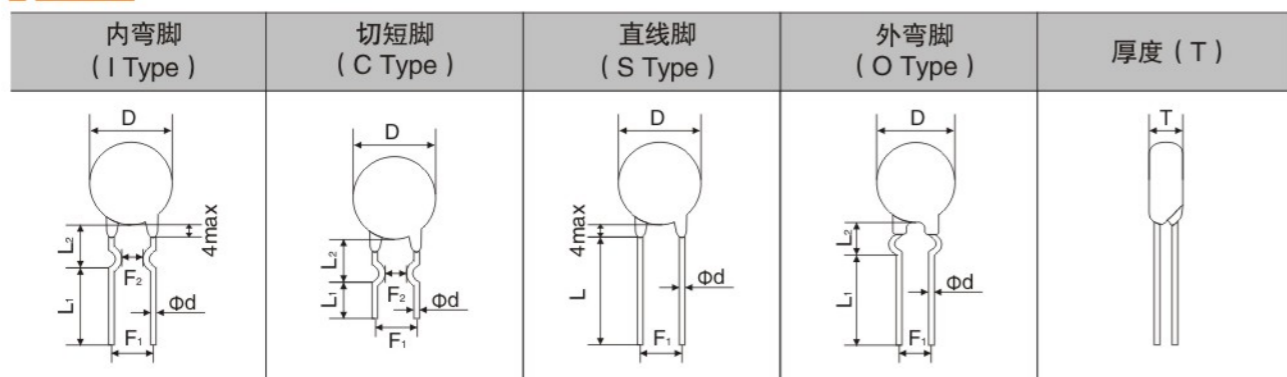

说明: 若非特别指出, 常用外形为内弯型长引线。

Note: if the particular shape, commonly used for bending type, namely the inner-bended forming for long lead

尺寸 SIZE

单位Unit: mm

尺寸Dim (mm) 代号 Sym 型号Part No.	Dmax	Tmax	φ d ± 0.05	F1 ± 1	F2 ± 1.5	直引线 Straight Lead wire		弯引线 Curved Lead wire	
						Lmin	L1 ± 1	L2 ± 2	
HEL□D-5	7	5	0.55	5	3	15	3.0-20	7 or 4	
HEL□D-7	9	5	0.55	5	3	15	3.0-20	7 or 4	
HEL□D-9	11	5.5	0.75/0.55	7.5/5	5/3	15	3.0-20	7 or 4	
HEL□D-11	13	5.5	0.75	7.5/5	5/3	15	3.0-20	7 or 4	
HEL□D-13	15.5	6	0.75	7.5	5	15	3.0-20	7 or 4	
HEL□D-15	17.5	6	0.75	10/7.5	5	15	3.0-20	7 or 4	
HEL□D-20	22.5	7	1	10/7.5	/	15		/	

MF72产品标志说明 MF72 PART NUMBER EXPLANATION

公司标志 THE COMPANY LOGO

	HEL	公司商标 Company logo
	MF72	功率型热敏电阻 Power Thermistor
	X	额定零功率电阻值 Rated Zero Power Resistance
	Y	最大芯片直径 Max diameter of disk (mm)
		HEL安规认证标志 HEL safety certification mark

通用标志 GENERAL MARK

	HEL	公司商标 Company logo
	□□	最大芯片直径 Safety Chip Diameter
	□ R □	额定零功率电阻值 (R代表小数点) Rated Zero Power Resistance (R Stands For Decimal Points)
	○	最大稳态电流 Max. steady State Current
		HEL安规认证标志 HEL Safety Certification Mark

中性标志 THE NEUTRAL MARKS

	NTC	负温度系数热敏电阻器 NTC thermistor
	X	额定零功率电阻值 Rated Zero Power Resistance
	D	圆片型 Wafer type
	Y	最大芯片直径 Max diameter of disk (mm)

以上所有类型标志统称圆片型, 如有特殊要求请与我们的销售人员联系, 产品规格与数据若有变更, 恕不另行通知。

All of the above types of marks round, if you have special request, please contact our sales staff, for product specification and data are subject to change without notice.



HEL□D-5 产品外形 PRODUCT APPEARANCE

单位Unit: mm

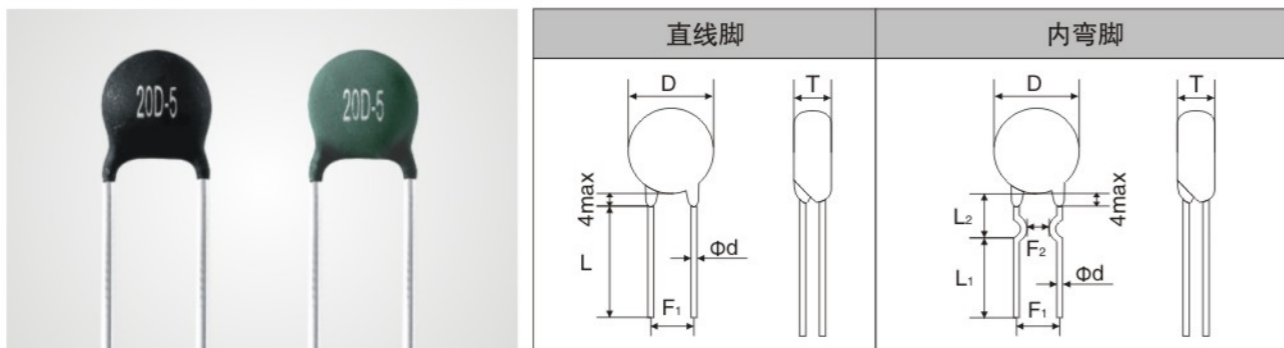

型号	最大直径 Dmax	最大厚度 Tmax	引线直径 φd±0.1	间距 F1±1	间距 F2±1.5	直引线 L	引线长度	
							L1±1	L2±2
□D-5	7	5.0	0.55	5.0	3.0	3.0-20	3.0-20	7or4

主要技术参数 MAIN TECHNICAL PARAMETERS

型号 Part No	R25 (Ω)	最大稳态电流 Max.steady State current (A)	残余电阻* Residual Resistance (Ω)	耗散系数* Dissipation Factor (mw/°C)	热时间常数* Thermal time Constant (s)	最大允许使用容量值 Maximum allowable capacity value 240V/120V(μF)	B值 (K)	工作温度 Operating Temperature (°C)	认证		
									UL/CUL	CQC	TUV
5D-5	5	1	0.35	6	20	39/150	2700	-40~+150	√		△
8D-5	8	0.7	0.77	6	20	39/150	2700	-40~+150	√		△
10D-5	10	0.7	0.77	6	20	39/150	2700	-40~+150	√		△
20D-5	20	0.5	0.997	6	20	39/150	2800	-40~+150	√		△
33D-5	33	0.5	1.88	6	20	39/150	2950	-40~+150	√		△

说明: △ 表示认证中  
\* 表示参考值

Note: △ Express authentication  
\* Represents a reference value

产品阻温特性  
Resistance-Temperature Characteristic

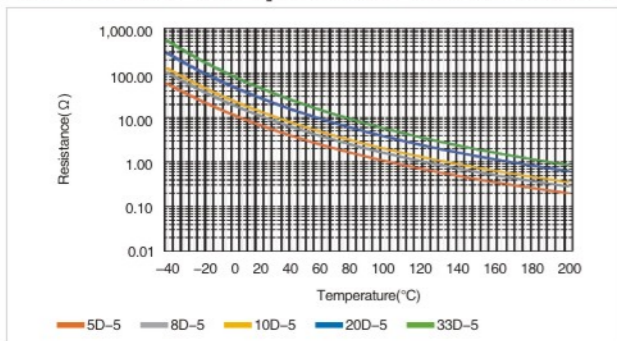

静态伏安特性  
Static Characteristics

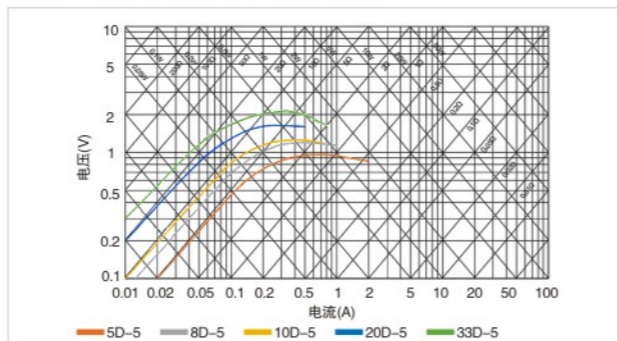

HEL□D-7 产品外形 PRODUCT APPEARANCE

单位Unit: mm

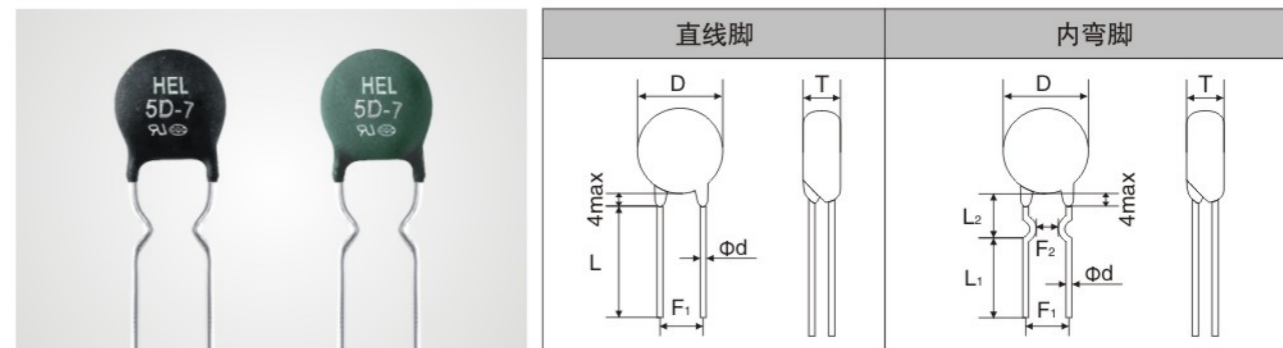

型号	最大直径 Dmax	最大厚度 Tmax	引线直径 φd±0.1	间距 F1±1	间距 F2±1.5	直引线 L	引线长度	
							L1±1	L2±2
□D-7	9	5.0	0.55	5.0	3.0	3.0-20	3.0-20	7or4

主要技术参数 MAIN TECHNICAL PARAMETERS

型号 Part No	R25 (Ω)	最大稳态电流 Max.steady State current (A)	残余电阻* Residual Resistance (Ω)	耗散系数* Dissipation Factor (mw/°C)	热时间常数* Thermal time Constant (s)	最大允许使用容量值 Maximum allowable capacity value 240V/120V(μF)	B值 (K)	工作温度 Operating Temperature (°C)	认证		
									UL/CUL	CQC	TUV
5D-7	5	2	0.28	10	30	100/390	2700	-40~+150	√	√	△
8D-7	8	1	0.77	6	20	100/390	2700	-40~+150	√	√	△
10D-7	10	1	0.77	6	20	100/390	2700	-40~+150	√	√	△
12D-7	12	1	0.82	9	27	100/390	2700	-40~+150	√	√	△
16D-7	16	0.7	1.00	9	27	100/390	2800	-40~+150	√	√	△
20D-7	20	0.6	1.11	9	27	100/390	2800	-40~+150	√	√	△
22D-7	22	0.6	1.11	9	27	100/390	2800	-40~+150	√	√	△
33D-7	33	0.5	1.49	10	28	100/390	2950	-40~+150	√	√	△

说明: △ 表示认证中  
\* 表示参考值

Note: △ Express authentication  
\* Represents a reference value

产品阻温特性  
Resistance-Temperature Characteristic

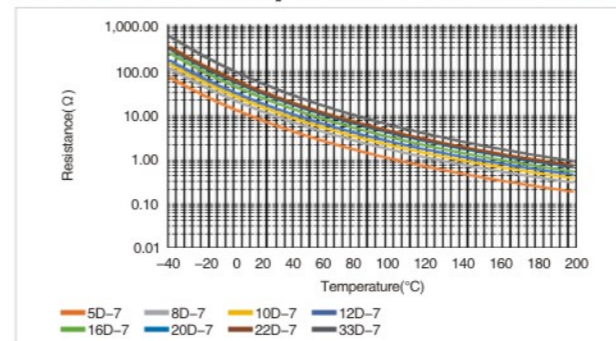

静态伏安特性  
Static Characteristics

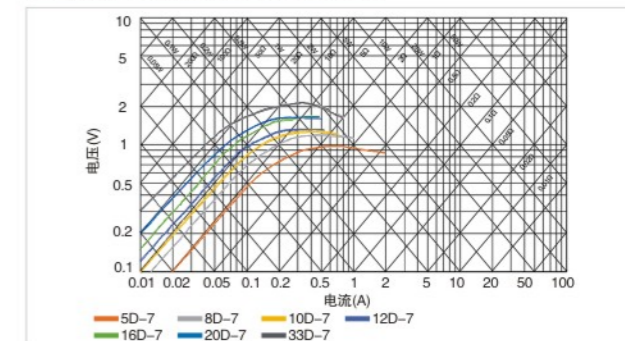



HEL□D-9 产品外形 PRODUCT APPEARANCE

单位Unit: mm

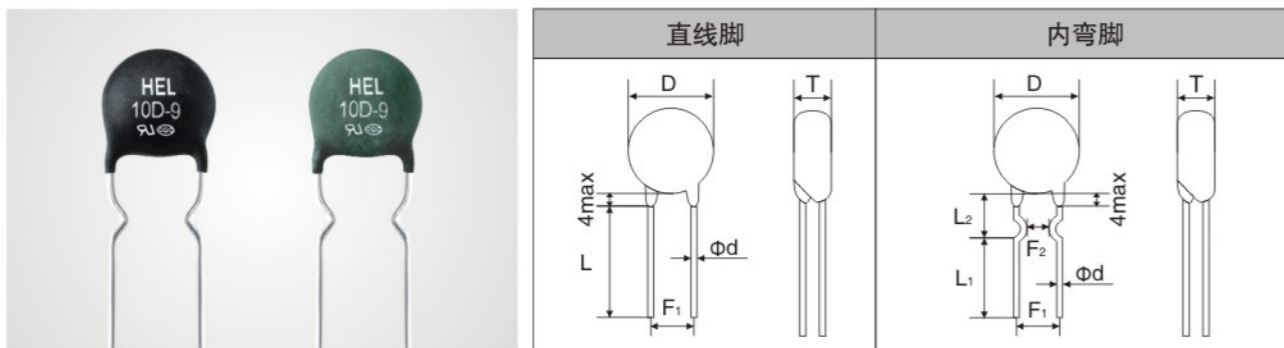

型号	最大直径 Dmax	最大厚度 Tmax	引线直径 φd±0.1	间距 F1±1	间距 F2±1.5	直引线 L	引线长度	
							L1±1	L2±2
□D-9	11	5.5	0.75/0.55	7.5/5.0	5.0/3.0	3.0-20	3.0-20	7or4

主要技术参数 MAIN TECHNICAL PARAMETERS

型号 Part No	R25 (Ω)	最大稳态电流 Max.steady State current (A)	残余电阻* Residual Resistance (Ω)	耗散系数* Dissipation Factor (mw/°C)	热时间常数* Thermal time Constant (s)	最大允许使用容量值 Maximum allowable capacity value 240V/120V(μF)	B值 (K)	工作温度 Operating Temperature (°C)	认证		
									UL/ CUL	CQC	TUV
3D-9	3	4	0.12	11	35	68/270	2600	-40~+175	✓	✓	△
5D-9	5	3	0.21	11	34	68/270	2700	-40~+175	✓	✓	△
6D-9	6	2	0.32	11	34	68/270	2700	-40~+175	✓	✓	△
8D-9	8	2	0.40	11	32	100/390	2700	-40~+175	✓	✓	△
10D-9	10	2	0.46	11	32	100/390	2700	-40~+175	✓	✓	△
12D-9	12	1	0.66	11	32	100/390	2700	-40~+175	✓	✓	△
15D-9	15	1	0.80	11	31	100/390	2800	-40~+175	✓	✓	△
16D-9	16	1	0.80	11	31	100/390	2800	-40~+175	✓	✓	△
20D-9	20	1	0.88	11	30	150/560	2800	-40~+175	✓	✓	△
22D-9	22	1	0.95	11	30	150/560	2800	-40~+175	✓	✓	△
33D-9	33	1	1.12	11	30	150/560	2950	-40~+175	✓	✓	△
50D-9	50	1	1.25	11	30	150/560	2950	-40~+175	✓	✓	△
100D-9	100	0.8	3.02	11	30	68/270	3200	-40~+175	✓	✓	△
120D-9	120	0.8	3.02	11	30	68/270	3200	-40~+175	✓	✓	△

说明: △ 表示认证中 Note: △ Express authentication \* 表示参考值 Note: \* Represents a reference value

产品阻温特性

Resistance-Temperature Characteristic

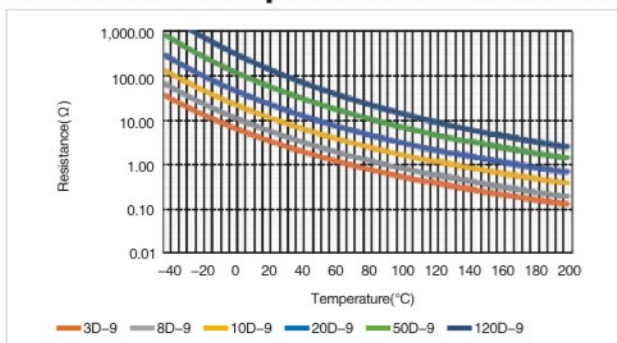

静态伏安特性

Static Characteristics

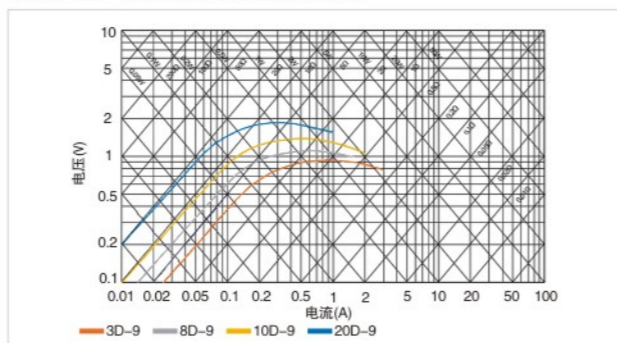

HEL□D-11 产品外形 PRODUCT APPEARANCE

单位Unit: mm

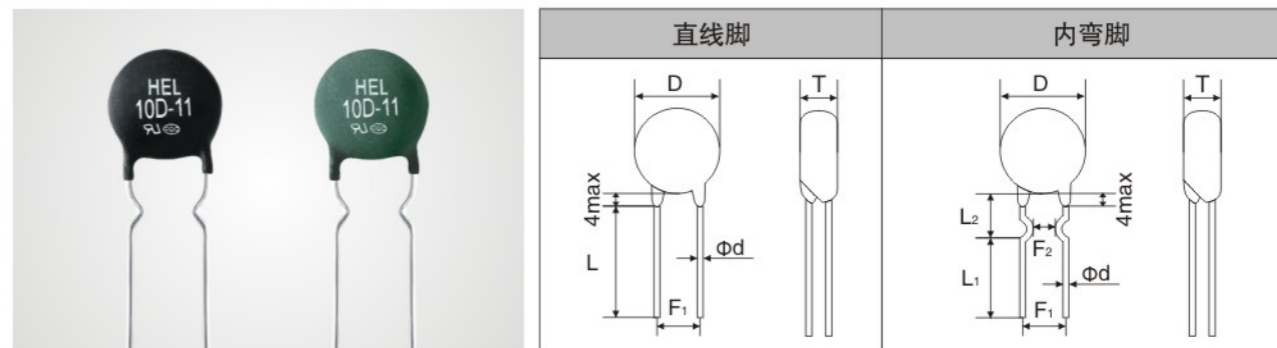

型号	最大直径 Dmax	最大厚度 Tmax	引线直径 φd±0.1	间距 F1±1	间距 F2±1.5	直引线 L	引线长度	
							L1±1	L2±2
□D-11	13	6.0	0.75	7.5/5.0	5.0/3.0	3.0-20	3.0-20	7or4

主要技术参数 MAIN TECHNICAL PARAMETERS

型号 Part No	R25 (Ω)	最大稳态电流 Max.steady State current (A)	残余电阻* Residual Resistance (Ω)	耗散系数* Dissipation Factor (mw/°C)	热时间常数* Thermal time Constant (s)	最大允许使用容量值 Maximum allowable capacity value 240V/120V(μF)	B值 (K)	工作温度 Operating Temperature (°C)	认证		
									UL/ CUL	CQC	TUV
2.5D-11	2.5	5	0.10	13	43	68/270	2700	-40~+175	✓	✓	△
3D-11	3	5	0.10	13	43	68/270	2700	-40~+175	✓	✓	△
5D-11	5	4	0.16	13	45	220/820	2700	-40~+175	✓	✓	△
8D-11	8	3	0.25	14	47	330/1200	2800	-40~+175	✓	✓	△
10D-11	10	3	0.28	14	47	330/1200	2800	-40~+175	✓	✓	△
12D-11	12	2	0.46	14	48	330/1200	2800	-40~+175	✓	✓	△
15D-11	15	2	0.47	14	50	330/1200	2800	-40~+175	✓	✓	△
16D-11	16	2	0.47	14	50	330/1200	2800	-40~+175	✓	✓	△
20D-11	20	2	0.51	15	52	330/1200	2950	-40~+175	✓	✓	△
22D-11	22	2	0.56	15	52	330/1200	2950	-40~+175	✓	✓	△
33D-11	33	1.5	0.67	15	52	330/1200	2950	-40~+175	✓	✓	△
47D-11	47	1.5	1.02	15	52	330/1200	2950	-40~+175	✓	✓	△
50D-11	50	1.5	1.02	15	52	330/1200	2950	-40~+175	✓	✓	△

说明: △ 表示认证中 Note: △ Express authentication \* 表示参考值 Note: \* Represents a reference value

产品阻温特性

Resistance-Temperature Characteristic

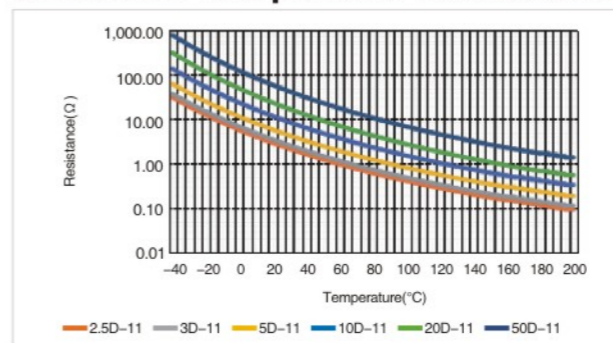

静态伏安特性

Static Characteristics

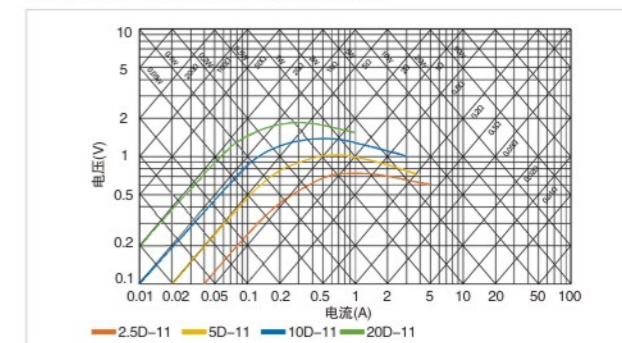



HEL□D-13 产品外形 PRODUCT APPEARANCE

单位Unit: mm

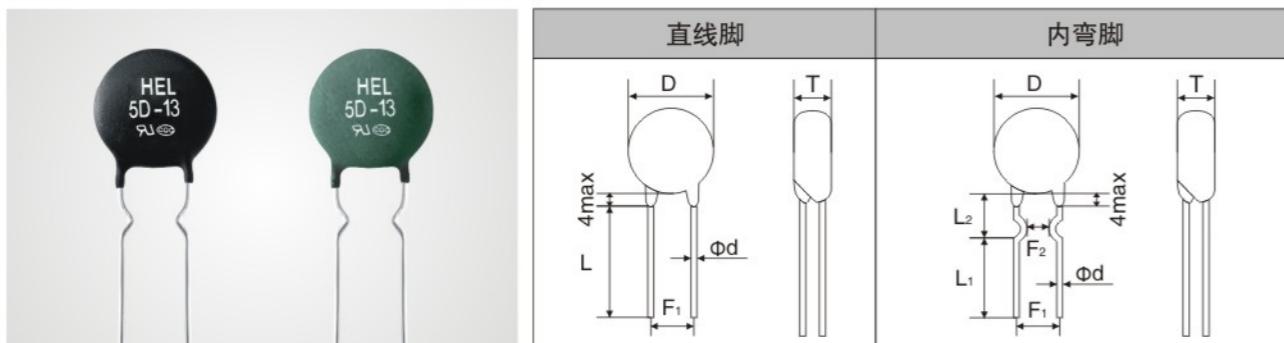

型号	最大直径 Dmax	最大厚度 Tmax	引线直径 φd±0.1	间距 F1±1	间距 F2±1.5	直引线 L	引线长度	
							L1±1	L2±2
□D-13	15.5	6.0	0.75	7.5	5.0	3.0-20	3.0-20	7or4

主要技术参数 MAIN TECHNICAL PARAMETERS

型号 Part No	R25 (Ω)	最大稳态电流 Max.steady State current (A)	残余电阻* Residual Resistance (Ω)	耗散系数* Dissipation Factor (mw/°C)	热时间常数* Thermal time Constant (s)	最大允许使用容量值 Maximum allowable capacity value 240V/120V(μF)	B值 (K)	工作温度 Operating Temperature (°C)	认证		
									UL/ CUL	CQC	TUV
2.5D-13	2.5	6	0.088	13	60	68/270	2600	-40~+200	✓	✓	△
3D-13	3	6	0.092	14	60	68/270	2600	-40~+200	✓	✓	△
4.7D-13	4.7	5	0.12	15	67	100/390	2700	-40~+200	✓	✓	△
5D-13	5	5	0.125	15	68	150/560	2700	-40~+200	✓	✓	△
8D-13	8	4	0.194	15	65	330/1200	2800	-40~+200	✓	✓	△
10D-13	10	4	0.206	15	65	330/1200	2800	-40~+200	✓	✓	△
16D-13	16	3	0.335	16	65	330/1200	2800	-40~+200	✓	✓	△
18D-13	18	3	0.372	16	65	330/1200	2800	-40~+200	✓	✓	△
20D-13	20	3	0.372	16	65	330/1200	2800	-40~+200	✓	✓	△
30D-13	30	2.5	0.517	16	65	330/1200	2950	-40~+200	✓	✓	△
47D-13	47	2	0.81	17	65	220/820	2950	-40~+200	✓	✓	△

说明: △ 表示认证中  
\* 表示参考值

Note: △ Express authentication  
\* Represents a reference value

产品阻温特性  
Resistance-Temperature Characteristic

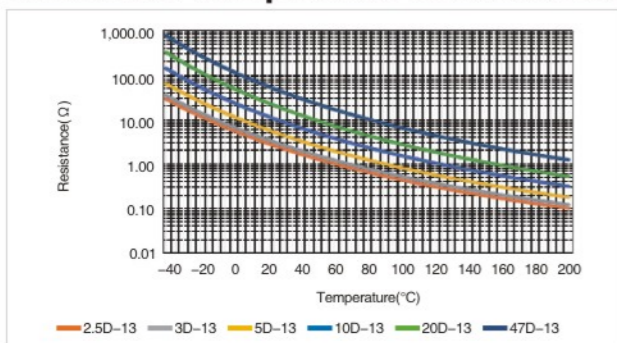

静态伏安特性  
Static Characteristics

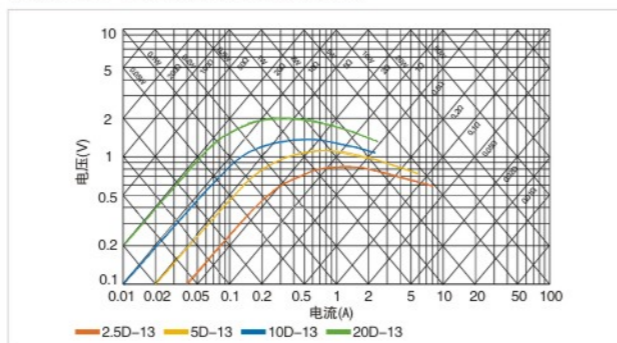

HEL□D-15 产品外形 PRODUCT APPEARANCE

单位Unit: mm

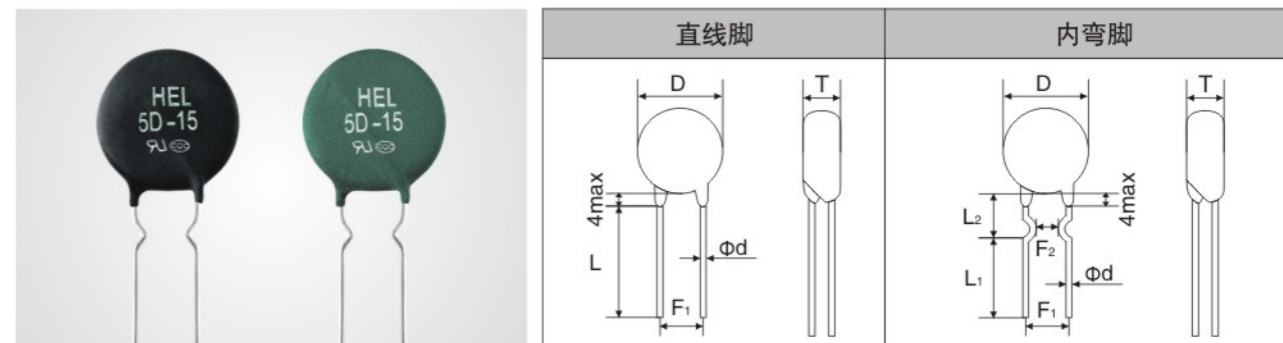

型号	最大直径 Dmax	最大厚度 Tmax	引线直径 φd±0.1	间距 F1±1	间距 F2±1.5	直引线 L	引线长度	
							L1±1	L2±2
□D-15	17.5	6.0	0.75	7.5	5.0	3.0-20	3.0-20	7or4

主要技术参数 MAIN TECHNICAL PARAMETERS

型号 Part No	R25 (Ω)	最大稳态电流 Max.steady State current (A)	残余电阻* Residual Resistance (Ω)	耗散系数* Dissipation Factor (mw/°C)	热时间常数* Thermal time Constant (s)	最大允许使用容量值 Maximum allowable capacity value 240V/120V(μF)	B值 (K)	工作温度 Operating Temperature (°C)	认证		
									UL/ CUL	CQC	TUV
1.5D-15	1.5	8	0.071	18	76	270/1000	2600	-40~+200	✓	✓	△
2.5D-15	2.5	8	0.071	18	76	330/1200	2600	-40~+200	✓	✓	△
3D-15	3	7	0.075	18	76	330/1200	2600	-40~+200	✓	✓	△
5D-15	5	6	0.112	20	76	470/1800	2800	-40~+200	✓	✓	△
7D-15	7	5	0.173	20	80	470/1800	2800	-40~+200	✓	✓	△
8D-15	8	5	0.178	20	80	470/1800	2950	-40~+200	✓	✓	△
10D-15	10	5	0.18	20	75	470/1800	2950	-40~+200	✓	✓	△
15D-15	15	4	0.268	21	85	470/1800	2950	-40~+200	✓	✓	△
16D-15	16	4	0.268	21	85	470/1800	2950	-40~+200	✓	✓	△
18D-15	18	4	0.288	17	86	470/1800	2950	-40~+200	✓	✓	△
20D-15	20	4	0.288	17	86	470/1800	2950	-40~+200	✓	✓	△
30D-15	30	3.5	0.438	18	75	330/1200	2950	-40~+200	✓	✓	△
47D-15	47	3	0.68	21	86	330/1200	3200	-40~+200	✓	✓	△
50D-15	50	3	0.72	21	86	330/1200	3200	-40~+200	✓	✓	△

说明: △ 表示认证中  
\* 表示参考值

Note: △ Express authentication  
\* Represents a reference value

产品阻温特性  
Resistance-Temperature Characteristic

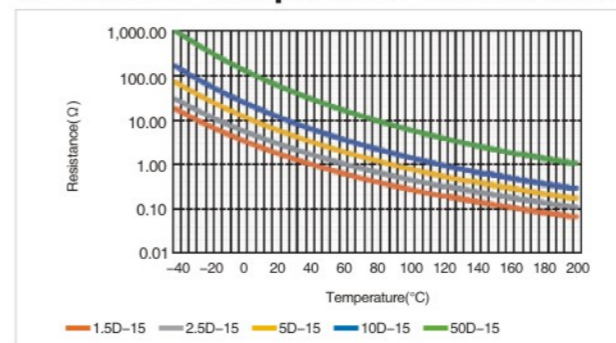

静态伏安特性  
Static Characteristics

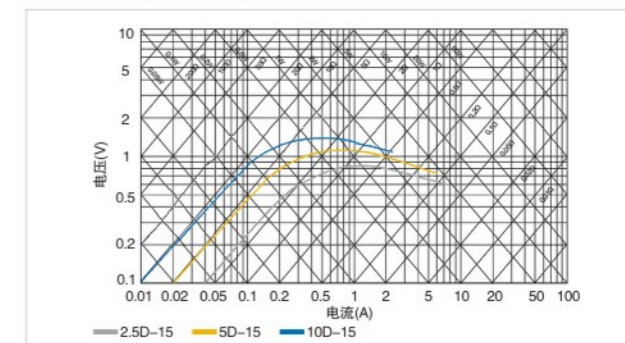



## HEL□D-20 产品外形 PRODUCT APPEARANCE

单位Unit: mm



型号	最大直径 Dmax	最大厚度 Tmax	引线直径 $\phi d \pm 0.1$	间距 $F1 \pm 1$	间距 $F2 \pm 1.5$	直引线 L
□D-20	22.5	7.0	1.0	10	/	3.0-20

## 主要技术参数 MAIN TECHNICAL PARAMETERS

型号 Part No	R25 ( $\Omega$ )	最大稳态电流 Max. steady State current (A)	残余电阻* Residual Resistance ( $\Omega$ )	耗散系数* Dissipation Factor (mW/ $^{\circ}$ C)	热时间常数* Thermal time Constant (s)	最大允许使用容量值 Maximum allowable capacity value 240V/120V( $\mu$ F)	B值 (K)	工作温度 Operating Temperature ( $^{\circ}$ C)	认证		
									UL/ CUL	CQC	TUV
1.3D-20	1.3	9	0.037	24	113	470/1800	2600	-40~+200	✓		△
1.5D-20	1.5	9	0.037	24	113	470/1800	2600	-40~+200	✓		△
2.5D-20	2.5	8	0.055	24	113	470/1800	2700	-40~+200	✓	✓	△
3D-20	3	8	0.055	24	113	470/1800	2700	-40~+200	✓	✓	△
5D-20	5	7	0.087	23	112	560/2200	2800	-40~+200	✓	✓	△
8D-20	8	6	0.142	25	115	560/2200	2950	-40~+200	✓	✓	△
10D-20	10	6	0.162	24	113	560/2200	2950	-40~+200	✓	✓	△
16D-20	16	5	0.212	25	113	560/2200	3200	-40~+200	✓	✓	△
20D-20	20	5	0.212	25	113	560/2200	3200	-40~+200	✓		△

说明: △ 表示认证中  
\* 表示参考值

Note: △ Express authentication

Note: \* Represents a reference value

## 产品阻温特性

## Resistance-Temperature Characteristic

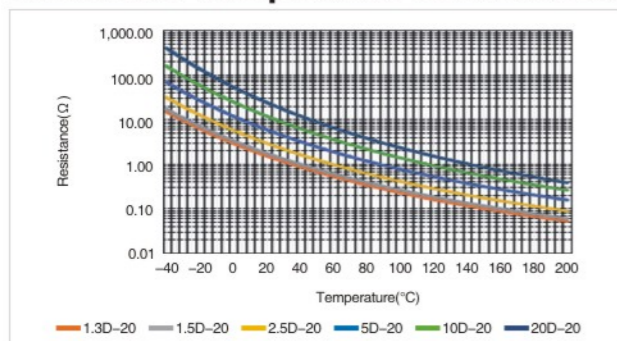

## 静态伏安特性

## Static Characteristics

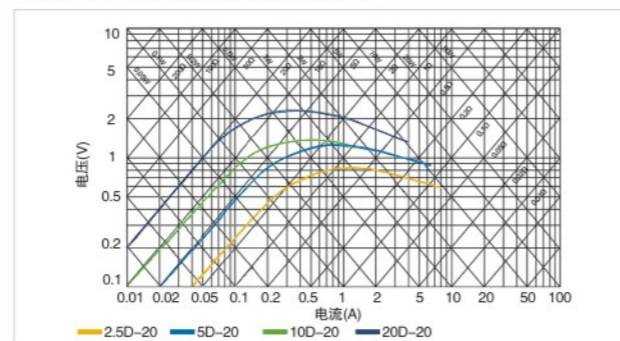

## 散装 BULK

## 散装包装箱尺寸 BULK PACKING CASE SIZE

产品包装 PRODUCT PACKAGING	内盒 INSIDE THE BOX	外箱 CARTON
散装 In Bulk	 260*210*55(L*W*H)	 430*280*180(L*W*H)

## 散装包装数量 QUANTITY OF PACKING IN BULK

## 常规产品包装 NORMAL PRODUCT PACKAGING

规格 DIMENSION	一袋 BAG	内盒 INSIDE THE BOX	外箱 CARTON
NTC□D-5	1000 pcs	3000 pcs	18000 pcs
NTC□D-7	1000 pcs	3000 pcs	18000 pcs
NTC□D-9	500 pcs	2000 pcs	12000 pcs
NTC□D-11	500 pcs	1500 pcs	9000 pcs
NTC□D-13	250 pcs	1000 pcs	6000 pcs
NTC□D-15	250 pcs	1000 pcs	6000 pcs
NTC□D-20	100 pcs	400 pcs	2400 pcs

## 切脚产品包装 CUT THE FEET PRODUCT PACKAGING

规格 DIMENSION	一袋 BAG	内盒 INSIDE THE BOX	外箱 CARTON
NTC□D-5	1000 pcs	8000 pcs	48000 pcs
NTC□D-7	1000 pcs	5000 pcs	30000 pcs
NTC□D-9	1000 pcs	4000 pcs	24000 pcs
NTC□D-11	1000 pcs	3000 pcs	18000 pcs
NTC□D-13	500 pcs	2000 pcs	12000 pcs
NTC□D-15	500 pcs	1000 pcs	6000 pcs
NTC□D-20	100 pcs	400 pcs	2400 pcs



**编带 BRAID**

**编带包装箱尺寸 SIZE OF WOVEN PACKING CASE**

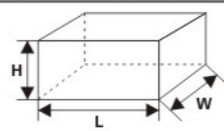
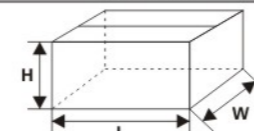
产品包装 PRODUCT ACKAGING	内盒 INSIDE THE BOX		外箱 CARTON	
编带 Taping	 335*265*45(L*W*H)		 540*360*295(L*W*H)	
每箱数量 Qty Per Box	产品数量(只) product quantity(pieces)	500 / 1000	产品数量(只) product quantity(pieces)	6000 / 12000

**编带包装式样 PACKING STYLE**

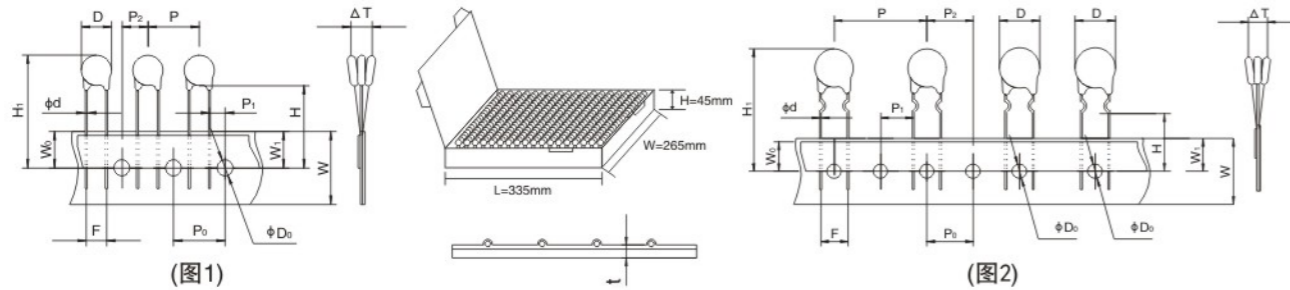

**编带尺寸 TAPE SIZE**

名称 DESCRIPTION	符号 SYMBOL	外观 EXTERIOR	产品直径 DIMENSION					
			φ 5	φ 7	φ 9-φ 11	φ 13	φ 15	φ 20
编带间距 Taping pitch	P ± 1	直脚/弯脚	12.7	12.7	25.4	25.4	30	30
输送孔间距 Feed hole pitch	P0 ± 1	直脚/弯脚	12.7	12.7	12.7	12.7	15	15
对输送孔的偏 Feed hole off alignment	P1 ± 0.7	直脚/弯脚	3.85	3.85	8.95	8.95	11.25	10.0
	P2 ± 1.3	直脚/弯脚	12.7	12.7	12.7	12.7	15	15
底部高度 Bottom height	H ± 1.0	直脚	20	20	21	24.5	23.5	21
		弯脚	18	18	18	21	21	/
顶部高度 Top height	H1max	直脚/弯脚	29.0	32.0	36.0	40	40	48.0
载带宽度 Carrier tape width	W ± 1.0	直脚/弯脚	18	18	18	18	18	18
胶带宽度 Adhesive tape width	W0max	直脚/弯脚	8.0	8.0	8.0	8.0	8.0	8.0
对输送孔的高度偏移 Feed hole height off alignment	W1 ± 0.5	直脚/弯脚	9.0	9.0	9.0	9.0	9.0	9.0
输送孔直径 Feed hole diameter	φ D0 ± 0.3	直脚/弯脚	4.0	4.0	4.0	4.0	4.0	4.0
本体直径 Body diameter	Dmax	直脚/弯脚	7.5	9.0	13.5	18.0	18.0	23.0
引线直径 Wire lead diameter	φ d ± 0.03	直脚/弯脚	φ 0.55	φ 0.55	φ 0.75	φ 0.75	φ 0.97	φ 0.97
产品在胶带上偏差 Deviation across tape	ΔT max	直脚/弯脚	2.0	2.0	2.0	2.0	2.0	2.0
编带总厚度 Overall tape thickness	t ± 0.2	直脚/弯脚	0.7	0.7	0.7	0.7	0.7	0.7
引线间距 Lead spacing	F ± 1.0	直脚/弯脚	5.0	5.0	7.5	7.5	10.0	10.0

**1.1**

**HEL 热敏电阻技术术语**

HEL NTC THERMISTOR TECHNICAL TERM

项目	标准术语	测试设备	要求
额定零功率电阻值	在基准25℃下测得的零功率电阻值, 也称为NTC热敏电阻的标称电阻值。零功率电阻值R <sub>T</sub> 是在规定温度下, 采用引起电阻值变化相对于总的测量误差来说可以忽略不计的测量功率测得的电阻值。	HG-2515型热敏电阻测试仪	电阻测量值在偏差允许范围内: M: ±20% L: ±15% K: ±10%; J: ±5%
热敏指数 B值(K)	B 值是负温度系数热敏电阻器的热敏指数, 它被定义为两个温度下零功率电阻值的自然对数之差与这两个温度倒数之差的比值。 $B = \frac{\ln(R_{T1}) - \ln(R_{T2})}{(1/T_1 - 1/T_2)}$ R <sub>T1</sub> : 温度为T <sub>1</sub> 时的零功率电阻值 R <sub>T2</sub> : 温度为T <sub>2</sub> 时的零功率电阻值 T <sub>1</sub> = 273.15 + 25 (°C)    T <sub>2</sub> = 273.15 + 50 / 85 (°C)	HG-2515型热敏电阻测试仪 恒温油槽	符合规格书要求
耗散系数(δ)	在规定环境温度下, NTC 热敏电阻耗散系数是电阻体耗散的功率变化与电阻体相应的温度变化之比, 即: $\delta = \frac{\Delta P}{\Delta T}$ 在工作温度范围内, δ 随环境温度变化而有所变化。 δ: NTC 热敏电阻耗散系数, (mW/K) ΔP: NTC 热敏电阻消耗的功率(mW) ΔT: NTC 热敏电阻消耗功率 ΔP 时, 电阻体相应的温度变化(K)	耗散系数测试仪	见主要技术参数表
热时间常数(τ)	在零功率条件下, 当温度突变时, 热敏电阻本体的温度变化到始末两个温度差的 63.2% 温度时所需的时间, 热时间常数 τ 与 NTC 热敏电阻的热容量 C 成正比, 与其耗散系数 δ 成反比, 即: $\tau = C / \delta$ τ: 热时间常数(S) C: NTC 热敏电阻的热容量 δ: NTC 热敏电阻的耗散系数	热时间常数测试仪	见主要技术参数表

Item	Standard terminology	Test equipment	Requirement
Rated zero power resistance	In the standard 25 °C ambient conditions measured resistance values, namely NTC thermistor standard resistance values. Under the specified temperature induced resistance changes relative to the total measurement error is negligible in the measurement of the power measured resistance values.	HG2515 thermistor tester	The measured resistance within the allowable tolerance: M: ±20% L: ±15% K: ±10% J: ±5%
B value (K)	B value stands for the thermal exponent at a negative temperature coefficient. It's defined as a ratio of the balance between the natural logarithms of resistance values at zero-power to the balance between the reciprocals of the two temperatures. The Formula is as below: $B = \frac{\ln(R_{T1}) - \ln(R_{T2})}{(1/T_1 - 1/T_2)}$ R <sub>T1</sub> : the zero power resistance at temperature T <sub>1</sub> (K) R <sub>T2</sub> : the zero power resistance at temperature T <sub>2</sub> (K) T <sub>1</sub> = 273.15 + 25 (°C)    T <sub>2</sub> = 273.15 + 50 or 85 (°C)	HG2515 thermistor tester Thermostatic oil bath	Comply with the specifications
Dissipation Factor	The dissipation factor is the ratio of the rate of change of the power consumption of a thermistor to the change of it's Corresponding temperature, namely: $\delta = \frac{\Delta P}{\Delta T}$ The value of δ will change for different ambient temperatures δ: NTC Thermistor dissipation factor, (mW/K) P: NTC Thermistor consumption power (mW) T: When the NTC thermistor consumption power is P, the corresponding change at resistor temperature (K).	Dissipation coefficient tester	See table of main technical parameters
Thermal time constant	The thermal time constant is a 63.2% change of thermistor's body temperature from its initial temperature to end temperature under zero power conditions. Thermal time constant is directly proportional to C, the heat capacity of thermistor, and is inversely proportional to δ, the dissipation constant. That is: $\tau = C / \delta$ T: Thermal time constant (S) C: The heat capacity of NTC thermistor δ: The dissipation factor of NTC thermistor	Thermal time constant test	See table of main technical parameters

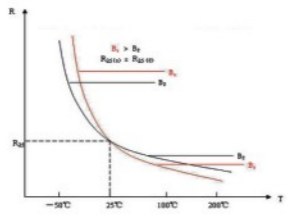
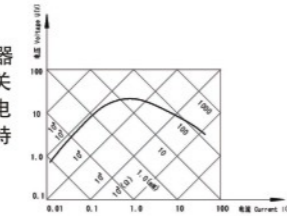

1.2 HEL 热敏电阻技术术语  
HEL NTC THERMISTOR TECHNICAL TERM

项目	标准术语	测试设备	要求
电阻-温度特性示意图	热敏电阻器的零功率电阻值与其电阻体温度之间的依赖关系。 	/	/
静态伏安特性示意图	静态伏安特性是指NTC热敏电阻器在建立了热平衡后电压与电流的关系，由于热敏电阻器的端电压与电流关系的变化幅度很大，其伏安特性曲线常用双对数坐标来表示。 	/	/
残余电阻	在标准测试条件下，通过热敏电阻器最大直流电流并达到热平衡时的电阻值。	稳态电流试验机	详见各规格产品技术参数表
最大允许容量	在负载状态下，与一个热敏电阻器连接的电容器的最大允许容量值。	最大允许容量试验机	零功率阻值变化率 ≤ ± 25%
最大稳态电流	在环境温度为25℃时允许施加在热敏电阻器上的最大连续直流电流。	最大稳态电流试验机	外观无损伤，阻值变化率 ≤ ± 25%

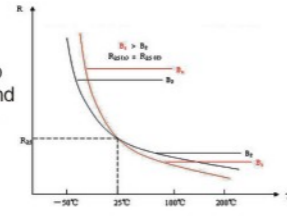
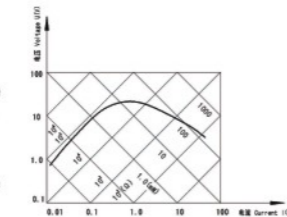
Item	Standard terminology	Test equipment	Requirement
Resistance-temperature Characteristic Sketch map	RT characteristic is the relationship between zero-power resistance and body temperature of the thermistor. R-T curve of NTC thermistor 	/	/
Static characteristics Sketch map	Static volt-ampere characteristic refers to the NTC thermistor in the establishment of the heat balance in the relationship between voltage and current, the thermistor voltage and current relationship changes greatly, the volt-ampere characteristic curve is often double logarithmic coordinates. 	/	/
Residual resistance	At standard test conditions, the AC resistance when the current flow through a thermistor and reach thermal equilibrium.	Steady-state current testing equipment	Details see technical parameter table
Maximum allowable capacitance	Under load conditions, the maximum allowable capacitance is the value of capacitor, which connect with a thermistor.	The maximum allowed capacity equipment	Rated zero power resistance's change rate ≤ ± 25%
Max.steady state current	The maximum allowable continuous current allowed to pass through the thermistor at 25°C.	Maximum steady state current test machine	Appearance no damage, resistance change rate ≤ ± 25%

2 机械性能  
MECHANICAL CHARACTERISTICS

指标项目	技术要求	测试条件/方法
可焊性	浸润部分上锡均匀，上锡面积 ≥ 95%	将引出端沾助焊剂后，浸入到温度为240-245℃、深度为15mm的锡槽中锡面距NTC本体下端6mm处，持续2-3秒。(参见IEC68-2-20 /GB2423.28 试验Ta)
耐焊接	无可见损伤	根据IEC68-2-20(GB2423.28)试验Tb进行试验。采用焊槽法，将引出端沾助焊剂后，浸入到温度为265 ± 5℃、深度为15mm的锡槽中，锡面距NTC本体下端6mm处，维持10 ± 1秒。在25 ± 2℃条件下恢复4-5h后，复测额定零功率电阻RN'。
引出端强度	无损坏	根据IEC68-2-21(GB2423.29)试验U进行试验。试验Ua: 拉力10N,持续10S; 试验Ub: 弯曲90°, 拉力5N,持续10S; 扭转180°, 拉力5N,持续10S。在25 ± 2℃条件下恢复4-5h后,复测额定零功率电阻RN'。

ITEM	SPECIFICATION	TEST CONDITIONS & METHODS
SOLDER-ABILITY	The terminals shall be uniformly tinned, and its area ≥ 95%	Dipping the NTC terminals to a depth of 15mm in a soldering bath of 240-245℃ and to the place of 6mm far from NTC body for 2-3s(See IEC68-2-20 /GB2423.28 Ta)
RESISTANCE TO SOLDERING HEAT	No visible mechanical damage. $\Delta R/RN \leq 20\%$ ( $\Delta R =  RN - RN' $ )	Dipping the NTC terminals to a depth of 15mm in a soldering bath of 265 ± 5℃ and to the place for 6mm below from NTC body for 10 ± 1s.After recovering 4-5h under 25 ± 2℃. The rated zero power resistance value RN' shall be measured. (See IEC68-2-20 /GB2423.28 Tb)
STRENGTH OF LEAD TERMINAL	No break out $\Delta R/RN \leq 20\%$ ( $\Delta R =  RN - RN' $ )	Fasten the body and apply a force gradually to each lead until 10N and then keep for 10sec, Hold body and apply a force to each lead until 90° slowly at 5N in the direction of lead axis and then keep for 10sec, and do this in the opposite direction repeat for other terminal. After recovering 4-5h under 25 ± 2℃, the rated zero power resistance value RN' shall be measured. (See IEC68-2-21/GB2423.29 Ua / Ub)



## 3

## 电气性能/测试条件/方法

## ELECTRICAL CHARACTERISTICS &amp; TEST CONDITIONS &amp; METHOD

指标项目	技术要求	测试条件/方法
额定零功率电阻	电阻测量值在偏差允许范围内: M: ±20%、L: ±15% K: ±10%、J: ±5%	环境温度 TA: 25°C ± 1°C 测试电压: 1.5VDC 在恒温TA 条件下, 放置1~2 小时后测得阻值RN。
热耗散系数 δ (MW/°C)	见主要技术参数表	在特定的环境温度下, 热耗散系数(δ) 为热敏电阻电功率消耗(ΔP)与本体温度变化量(ΔT)的比值。
热时间常数 τ (S)	见主要技术参数表	热时间常数(τ) 为在零功率条件下, 热敏电阻的温度下降到其最初温度与最终温度之差为63.2% 时所需要的时间。
材料常数	见主要技术参数表	R1, R2 分别为 T1, T2 温度下的零功率电阻
最大稳态电流(A)	无可见损伤	环境温度: 25°C ± 2°C 见主要技术参数表

ITEM	SPECIFICATION	TEST CONDITIONS & METHODS
RATED ZERO-POWER RESISTANCE RN (Ω)	The resistance measurement value is within the allowable range of deviation: M: + 20% and L: + 15% K: + 10% and J: + 5%	Ambient temp. Range: 25°C ± 1°C(TA). Testing voltage: 1.5VDC After placing for 1~2 hours under TA, the resistance value shall be measured
THERMAL DISSIPATION CONSTANT	See the main technical parameter list	The thermal dissipation constant(δ) could be calculated by the ratio of a change in power dissipation(ΔP) of the thermistor to a change in temperature(ΔT) of the thermistor at a specified ambient temperature
THERMAL TIME CONSTANT	See the main technical parameter list	The time(τ) shall be measured within which the temperature change of NTC thermistor is reached at 63.2% of the ambient temperature change under zero power condition
MATERIAL CONSTANT B	See the main technical parameter list	R1, R2 is zero-power resistance at T1, T2 T1 = 298.15 K(25°C) T2 = 323.15 K(50°C)
MAX. STEADY STATE CURRENT	VISIBLE MECHANICAL DAMAGE. ΔRN/RN ≤ 20% (ΔR =  RN-RN' )	Ambient temp. Range. 25°C ± 2°C Testing Current. See the main technical parameter list

## 4

## 可靠性试验(周期性检测项目)

## RELIABILITY TEST (PERIODIC TEST ITEMS)

指标项目	技术要求	测试条件/方法
温度循环测试	无可见损伤	在Ta=-40 ± 3°C和Tb=200 ± 3°C的环境温度中各存放30分钟, 循环5 次.每次高低温循环都有在25 ± 2°C的环境中过渡5分钟. 样品进行温度循环测试后, 取出放置室温(25 ± 2°C)4~5小时后测量零功率电阻RN'。
电循环测试	无可见损伤	环境温度: 25°C ± 2°C. 循环次数: 1,000次 通/断: 1分钟 / 5分钟 测试电流: 最大稳态电流 (A) 样品置于室温(25 ± 2°C)4~5小时后, 测量其零功率电阻RN'。
持久性测试	无可见损伤	环境温度: 25°C ± 2°C. 样品通过最大工作电流1,000 ± 24小时后, 取出置于室温(25 ± 2°C)4~5小时后, 测量其零功率电阻RN'。
耐湿性测试	无可见损伤	在温度40 ± 2°C, 相对湿度93 ± 3%的环境中放置1000 ± 24小时后, 取出置于室温(25 ± 2°C)4~5 小时后, 测量其零功率电阻RN'。

ITEM	SPECIFICATION	TEST CONDITIONS & METHODS
TEMP. CYCLING TESTING	No visible mechanical damage. ΔRN / RN ≤ 20% (ΔR =  RN-RN' )	Ta: -40 ± 3°C/30min → 25 ± 2°C/ 5min → Tb: 200 ± 3°C/30min → 25 ± 2°C/ 5min Cycles: 5 times After recovering 4~5 h under 25 ± 2°C, the rated zero power resistance value RN' shall be measured.
ELECTRICAL CYCLING TESTING	No visible mechanical damage. ΔRN / RN ≤ 20% (ΔR =  RN-RN' )	Ambient temp. Range: 25°C ± 2°C. Cycles: 1,000 times On / Off: 1m / 5m Test Current: MAX. STEADY STATE CURRENT After recovering 4~5h under 25 ± 2°C, the rated zero power resistance value RN' shall be measured.
LOADLIFE (ENDURANCE) TESTING	No visible mechanical damage. ΔRN / RN ≤ 20% (ΔR =  RN-RN' )	Ambient temp. Range: 25°C ± 2°C; 1,000 ± 24h After recovering 4~5 h under 25 ± 2°C, the rated zero power resistance value RN' shall be measured.
HUMIDITY TESTING	No visible mechanical damage. ΔRN / RN ≤ 20% (ΔR =  RN-RN' )	Ambient temp. range: 40°C ± 2°C R.H.: 93 ± 3% , Energized time: 1000 ± 24h After recovering 4~5h under 25 ± 2°C, the rated zero power resistance value RN' shall be measured



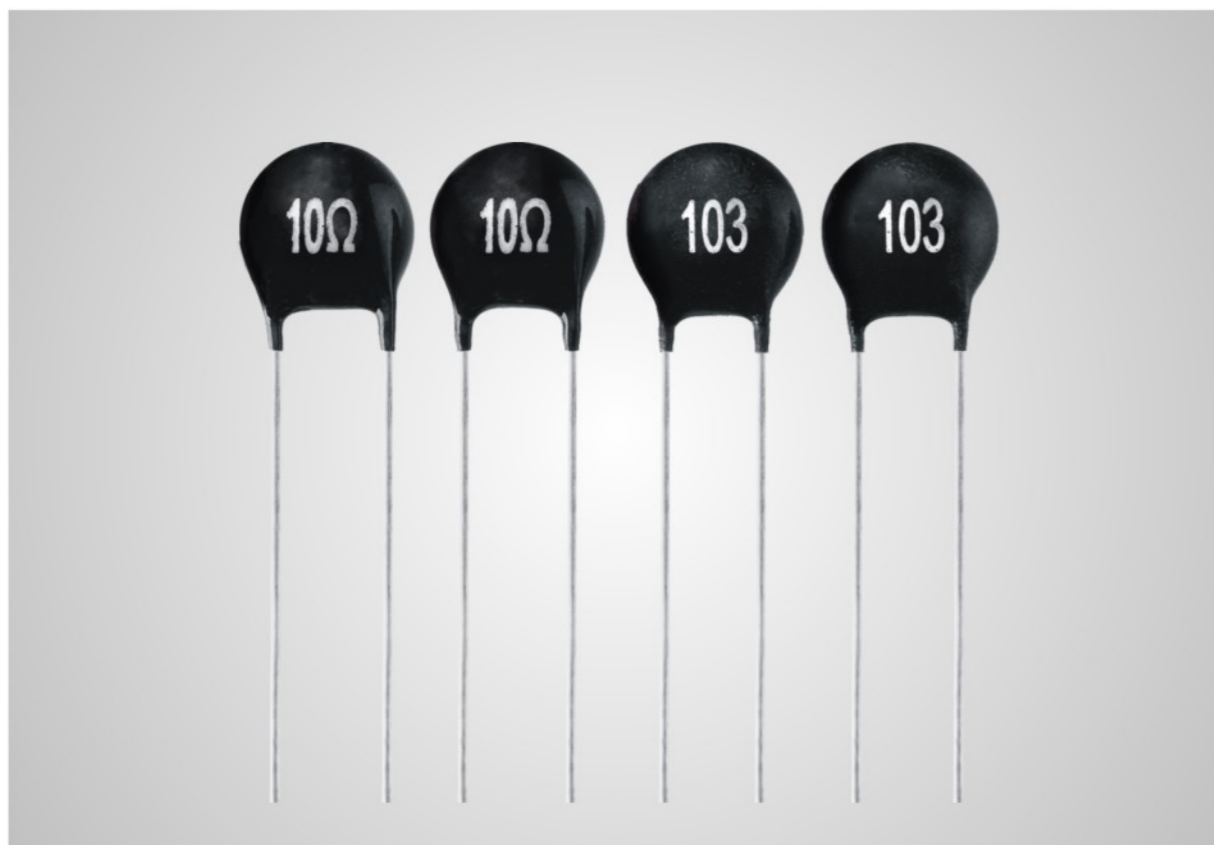

## MF11 温补型热敏电阻

### MF11 TEMPERATURE COMPENSATION TYPE NTC THERMISTOR

#### 产品简介 APPLICATIONS

MF11温补型NTC热敏电阻用于一般精度的温度测量和在计量设备、电子电路中的温度补偿。其尺寸小，通常芯片为5mm以下，阻值精度较功率型高，通常在10%以内。

MF11 temperature compensation type NTC thermistor for temperature measurement precision and measure equipment, Temperature compensation in measuring equipments and Electronic circuit. Its small size, high precision, usually less than 10%.

#### MF11订货型号说明 MF11 HEL PART NUMBER CODE

##### 产品型号说明 Part number explanation

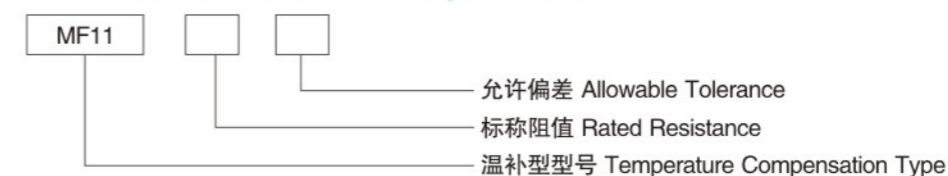

##### 特点 Characteristics

- 阻值范围宽  Broad range of Resistance
- B值系列全  wide choice field of B value
- 性能可靠  good stability
- 一致性好  good quality of coherence and Interchange

##### 外形尺寸 Dimensions(mm)

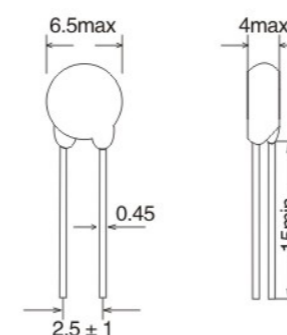

##### 主要技术参数 Main technical parameter

参数 Parameter	数值 Value
标称阻值及允差 Rated resistance and tolerance	见下表 See following table
B值及允差 B Value and tolerance	见下表 See following table
时间常数 Time constant	≤30s
耗散系数 Thermal dissipation coefficient	≥6mW/°C
测量功率 Testing Power	≤0.5mW
额定功率 Rated Power	0.5W
使用温度范围 Operation Temperature Range	-55~+125°C

##### 阻值、B值一览表 The table of resistance and B Value

型号 Part No	25°C时额定零功率电阻值 Rated Zero-power resistance at 25°C		B值(25/50°C) B Value(25/50°C)	
	阻值范围(Ω) Resistance range(Ω)	允许偏差(%) Allowable Tolerance	标称值(K) Rated Value(K)	允许偏差(%) Allowable Tolerance
MF11	3.3-33	J: ± 5% K: ± 10%	2700	± 5%
	6.8-68		2830	
	15-150		2950	
	33-330		3100	
	68-680		3250	
	150-1500		3400	
	330-3300		3570	
	680-6800		3740	
	1500-15000		3900	
	3300-33000		4050	



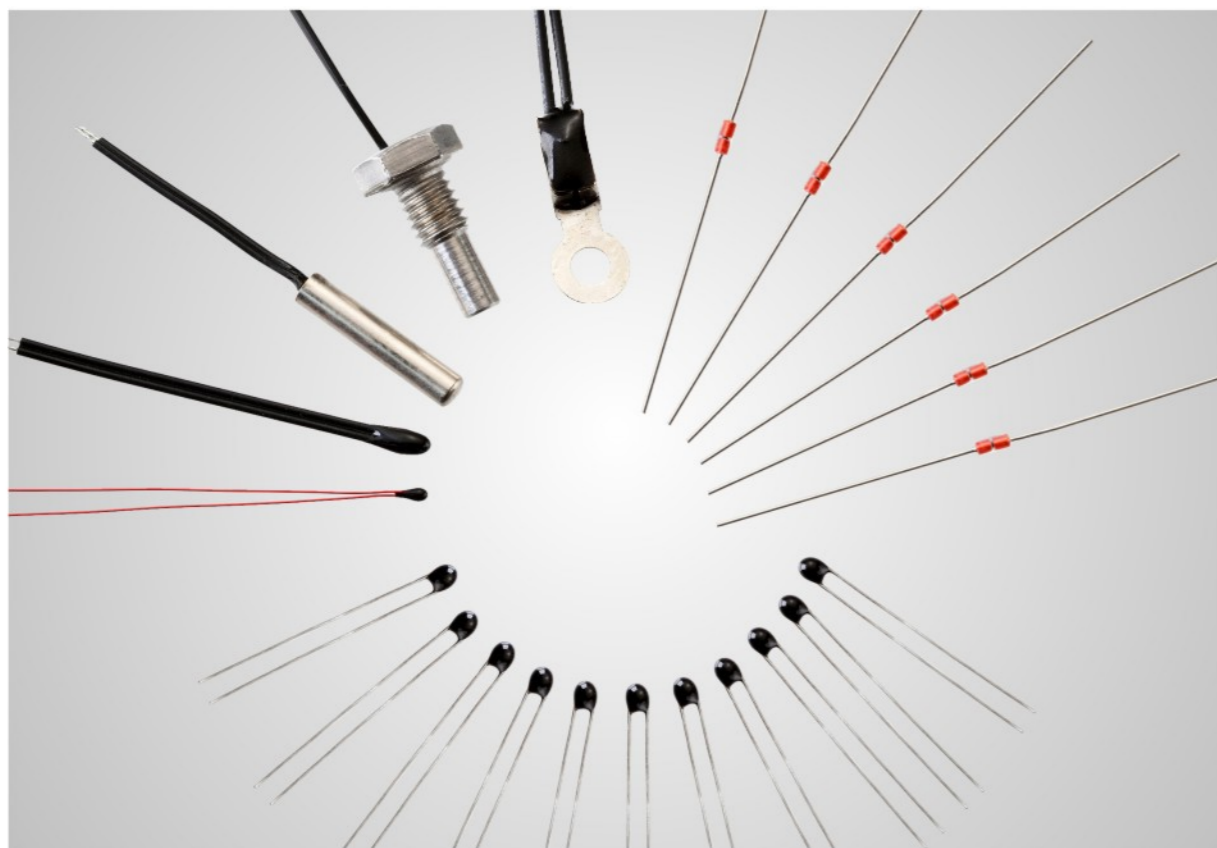

## NTC 温度传感器

### NTC TEMPERATURE SENSOR

#### 产品简介 PRODUCTS BRIEF INTRODUCTION

NTC温度传感器是一种以过渡金属氧化物为主要材料经高温烧结而成的半导体陶瓷元件。它具有非常大的负温度系数，电阻值随环境温度或通过电流产生自然而发生变化，即在一定测量功率下，电阻值随温度上升而有规律下降。利用这一特性，可将NTC温度传感器通过测量其电阻值来确定相应的温度，从而达到检测和控制温度的目的。其零功率电阻值精度要求在 $\pm 5\%$ ，通常要求 $\pm 1\sim 2\%$ 以内，B值精度在 $\pm 2\%$ 以内。

本公司NTC温度传感器分三类：MF52型、MF58型、CWF型。

NTC temperature sensor is the semiconductor ceramic components produced by sintering the material at high temperature and mainly from metal oxide. It has a large negative temperature coefficient. Its resistance changes with the environmental temperature or the heat by current flowing through the thermistor. At certain measure power, its resistance reduce rapidly when the temperature getting increases. Using this characteristic, can know the temperature by measuring the NTC temperature sensor's resistance, so that achieve the purpose of temperature test and control.

The sensor is divided into three categories: MF52 type, MF58 type, CWF type.

#### MF52珠状测温型NTC热敏电阻器

#### MF52 PEARL-SHAPE PRECISION NTC THERMISTOR

##### 产品简介 Introduction

MF52珠状测温型NTC热敏电阻器是小体积的环氧树脂包封型NTC热敏电阻器，根据使用范围的不同，已派生多种系列产品。Mf52 Pearl-Shape Precision NTC Thermistor is ethoxyline resin-enveloped thermistor in Small size which is made from new material and by new technique, so we have researched and developed several kinds of products, according to the different application fields.

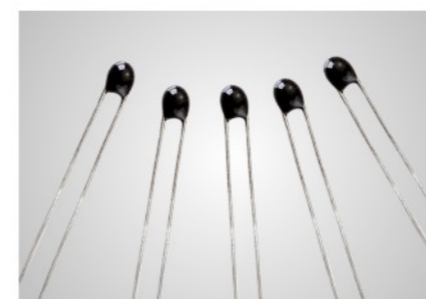

##### 应用范围 Application

- 空调设备
- 暖气设备
- 电子体温计
- 液位传感器
- 汽车电子
- 电子台历
- 手机电池
- Air-condition Equipments
- Heating Apparatus
- Electric Thermometer
- Liquid Level Sensor
- Automobile Electricity
- Electric Table-board
- Battery of Mobile Telephone

##### 特点 Characteristic

- 测试精度高
- 体积小，反应速度快
- 能长时间稳定工作
- 互换性，一致性好
- 规模化生产，性价比高
- High precision
- Small size, fast response time
- Steady operating for long time
- Good coherence and interchangeability
- Scale production, high cost performance

##### 产品型号说明 Specification

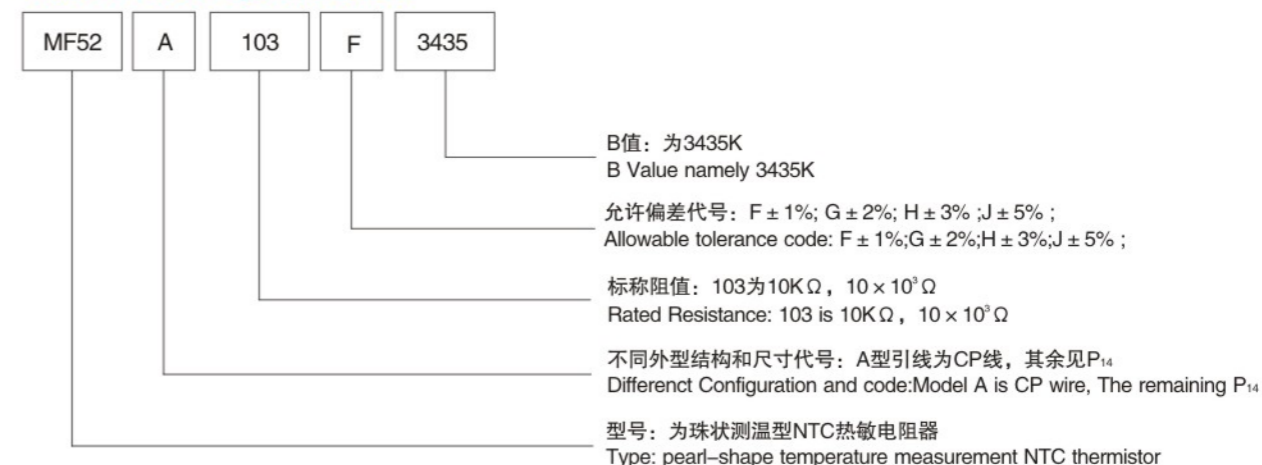



MF52电性能参数 MF52 Electronic Parameter Specification

表1

产品型号 Part NO.	标称阻值 $R_{25}$ Rated Resistance $R_{25}$ (K $\Omega$ )	B值 (25/50 $^{\circ}$ C) B Value (25/50 $^{\circ}$ C) (K)	额定功率 Rated Power(mW)	耗散系数 Dissi. Coef. (mW/ $^{\circ}$ C)	热时间常数 Thermal time Constant (s)	工作温度 Operating Temp. ( $^{\circ}$ C)
MF52□□□3100	0.1 ~ 20	3100	≤ 50	≥ 2.0 静止空气中 In Still Air	≤ 15 静止空气中 In Still Air	-55 ~ +125 $^{\circ}$ C
MF52□□□3270	0.2 ~ 20	3270				
MF52□□□3380	0.5 ~ 20	3380				
MF52□□□3435	0.5 ~ 50	3435				
MF52□□□3600	1 ~ 100	3600				
MF52□□□3950	5 ~ 100	3950				
MF52□□□3977	5 ~ 100	3977				
MF52□□□4000	5 ~ 100	4000				
MF52□□□4050	5 ~ 200	4050				
MF52□□□4150	10 ~ 250	4150				
MF52□□□4300	20 ~ 1000	4300				
MF52□□□4500	20 ~ 1000	4500				

注 Remark

- 第一方框填不同外形结构代号。第二方框填标称电阻值；第三方框填标称电阻值的精度代号。
- B值 (25/50 $^{\circ}$ C) 精度：对于标称电阻值精度为 $\pm 1\%$ 的，B值对应精度为 $\pm 1\%$ ，其余B值精度均为 $\pm 2\%$ 。
- 除以上规格外，我公司还可根据用户特殊要求供货。
- The first pane fills whith code of different dimension. The second pane fills with RatedResismce, the third fills with its precision symbol.
- B value (25/50 $^{\circ}$ C)error: the corresponding error is  $\pm 1\%$  for which the precision of therated resistance is  $\pm 1\%$ , others ls  $\pm 2\%$ .
- Besides, our corporation can supply products according to the demands of users.

注意事项 Notice

- 由于MF52系列体积较小，焊点小，引线两端不能承受过大拉力。
- 焊接时，请在距引线根部至少5mm处焊接，焊接时间尽量短，以免芯片受热冲击导致性能劣化。
- The two ends of the wire cannot endure too big pull because of the Small size and soldered spot in series of MF25.
- While soldering, please soldering at the distance of 5mm from the bottom of wrie at least and the period of sloding should be as short as possible.

MF52外形结构和尺寸 MF52 dimension of normal products:

A型：引线为镀锡铜线或镀锡铜包钢线 Tinned copper wire or CP wire

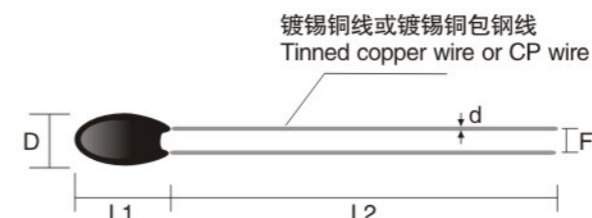

常规尺寸表  
Normal dimension table 单位Unit:mm

代号 Code	Dmax	L1max	L2min	d $\pm 0.05$	F $\pm 0.5$
A1	2.5	3.5	25	0.3	2.0
A2	3	4	25	0.45	2.5

B型：引线为漆包线 Enamelled cu wire

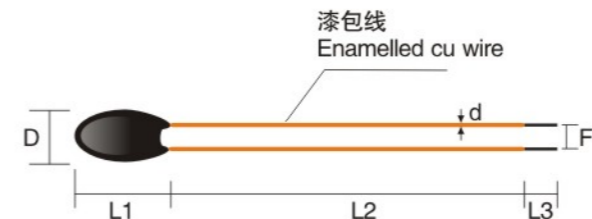

常规尺寸表  
Normal dimension table 单位Unit:mm

代号 Code	Dmax	L1max	L2min	L3 $\pm 1$	d $\pm 0.06$	F $\pm 0.5$
B1	2	3.5	用户规定	3	0.2	2.0
B2	3	4	用户规定	3	0.3	2.5

C型：引线为高温氟塑线 High temp fluorine-plastic wire

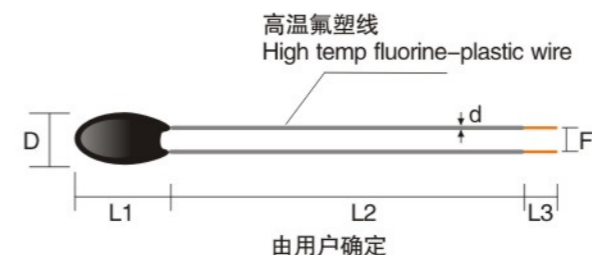

常规尺寸表  
Normal dimension table 单位Unit:mm

代号 Code	Dmax	L1max	L2min	L3 $\pm 1$	d $\pm 0.06$	F $\pm 0.5$
C1	3	3.5	用户规定	5	0.4	2.0
C2	4	4	用户规定	5	0.5	2.5

D型：引线为PVC导线 PVC wire

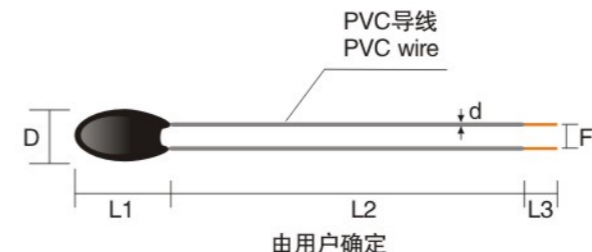

常规尺寸表  
Normal dimension table 单位Unit:mm

代号 Code	Dmax	L1max	L2min	L3 $\pm 1$	d $\pm 0.05$	F $\pm 0.5$
D1	3	3.5	用户规定	5	0.26	2.5
D2	4	4	用户规定	5	0.32	2.5



## MF58玻璃测温型NTC热敏电阻器

## MF58 PEARL-SHAPE PRECISION NTC THERMISTOR

## 产品简介 Introduction

采用陶瓷工艺与半导体相结合的工艺制作而成，为两端轴引出线玻璃封装结构。

It is made by the combinative technique of ceramics and semiconductor, is the axial glass encapsulated NTC thermistor.

## 应用范围 Application

- 家用电器（如空调机、微波炉、电风扇、电取暖炉等）的温度控制与温度检测
- 办公自动化设备（如复印机、打印机等）的温度检测或温度补偿
- 工业、医疗、环保、气象、食品加工设备的温度控制与检验
- 仪表线圈、集成电路、石英晶体振荡器和热电偶的温度补偿
- 液面指示和流量测量
- 手机电池
- Temperature control and examination of household electrical appliance (such as air-condition, microwave oven, fanner, electric heating and so on)
- Temperature examination and Lompensation of automatic work facilities (such as copycat, printer and so on).
- Temperature control and examination of industry, medical apparatus and instruments, environment protection, weather, foods machining equipments
- Indication of the liquid
- Battery of mobile telephone
- Temperature compensation of loops of instrument, integrate circuit, quartz crystal monofier and themocouple.

## 特点 Characteristic

- 稳定性好、可靠性高
- 阻值范围宽：0.1 ~ 1000K $\Omega$
- 阻值精度高，互换性好
- 由于采用玻璃封装，可在高温和高湿等恶劣环境下使用
- 体积小、质量轻、结构坚固、便于自动化安装
- Good stability, high reliability
- Resistance range: 0.1 ~ 1000K $\Omega$
- High resistance precision, good interchangeability
- Due to adoption of glass sealed, it can be used in severe environment, like high temperature, high humidity
- Small volume, light weight, firm structure, convenient installation

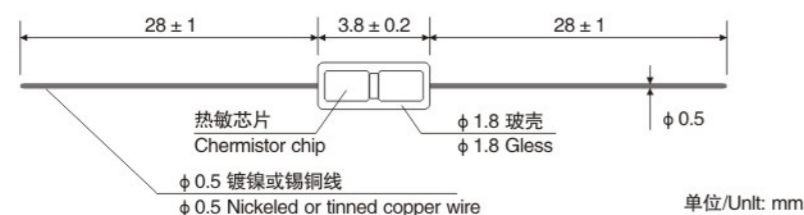

## MF58 电性能参数 MF58 Electrical properties

参数与规格参见P15表1，MF58对应MF52各规格，MF58应用温度范围为-55~+200 $^{\circ}$ C。

See Table 1 at P15 for reference, MF58 has the wider range operation temperature characteristic, MF58 Application temperature range -55~+200 $^{\circ}$ C.

## CWF 精密型温度传感器 PEARL-SHAPE PRECISION NTC THERMISTOR

## 产品简介 Introduction

将高精度、高灵敏、高可靠的NTC热敏电阻器与PVC导线连接，用绝缘、导热、防水材料封装成需要的形状，便于安装与远距离测控温。

That combining the high precision, sensitive and security NTC thermistor with PVC wire, packing into the needed shape with the insulating, heat-conduction and water-protection material will be convenient for installation and long-distance temperature measurement and control.

## 应用范围内 Application

应用于家用空调、汽车空调、冰箱、冷柜、热水器、饮水机、暖风机、洗碗机、消毒柜、洗衣机、烘干机以及中低温干燥箱、恒温箱等场合的温度测量与控制。（参数及规格见P15页电性能参数）

Temperature measurement and control of household and automobile air-condition, refrigeratory, icebox, water heater, drinking trough, radiator, dishwasher, disinfectant, washing machine, drying machine, middle-or-low-temperature drying box and constant temperature box. (Parameters and specifications see pages P13 electric performance parameter)

## 特点 Characteristic

- 采用全新工艺，产品性能稳定，可长期使用
- 阻值和B值精度高、一致性好
- 具有良好的绝缘，密封性、抗机械碰撞
- 可按用户要求设计生产
- Adopt new technology, good product performance, can be used for long time
- High sensitivity, fast response time
- Good insulation sealing, resistance to mechanical impact
- Can be customized design and production

## 电性能参数 Electrical properties

参数与规格参见P15表1，CWF对应MF52各规格。

See Table 1 at P15 for reference.



## CWF51型环氧封装温度传感器

示例(可根据客户要求定制):

阻值:  $R_{25}=10K\Omega \pm 1\%$

线长:  $10 \pm 2$ mm

应用: 电池、电机、空调、遥控器、玩具等

B值:  $B_{25/50}=3435K \pm 1\%$

线型: PVC线

## CWF51 epoxy encapsulation temperature sensor

The sample (which can be customized according to customer requirements):

Resistance:  $R_{25}=10K\Omega \pm 1\%$

Lead length:

Application: battery, motor, air conditioning, remote control toys, etc.

The value of B:  $B_{25/50}=3435K \pm 1\%$

Lead type: PVC wire



## CWF52型金属壳封装温度传感器

示例(可根据客户要求定制):

阻值:  $R_{25}=10K\Omega \pm 1\%$

线长:  $70 \pm 3$ mm

端子: XH-2Y型

应用: 热水器、电热壶、锅炉控温等

B值:  $B_{25/50}=3950K \pm 1\%$

线型: 高温氟塑线

应用: 热水器、电热壶、锅炉控温等

## CWF52 type metal shell packaging temperature sensor

The sample (which can be customized according to customer requirements):

Resistance:  $R_{25}=10K\Omega \pm 1\%$

Length:  $70 \pm 3$ mm

Terminal type: XH-2Y

Application: water heater, electric kettle, boiler temperature control etc.

The value of B:  $B_{25/50}=3950K \pm 1\%$

Type: high temperature fluorine plastic line



## CWF53表面贴装型温度传感器

示例(可根据客户要求定制):

阻值:  $R_{25}=100K\Omega \pm 1\%$

线长:  $10 \pm 2$ mm

应用: 电烫锅、咖啡机、音箱功放等

B值:  $B_{25/50}=3990K \pm 1\%$

线型: PVC线

## CWF53 surface mount type temperature sensor

The sample (which can be customized according to customer requirements):

Resistance:  $R_{25}=100K\Omega \pm 1\%$

Length:  $10 \pm 2$ mm

Application: a pot, coffee machine, loudspeaker amplifier

The value of B:  $B_{25/50}=3990K \pm 1\%$

Type: line PVC



## NTC温度传感器阻温特性参考表(一)

## RESISTANCE-TEMP. CHARACTERISTIC TABLE OF COMMON SPEC.

单位Unit: KΩ

R(KΩ) t(°C)	3	3	5	5	10	10	10	10
B <sub>25/50</sub>	3380	3435	3270	3380	3380	3435	3470	3950
B <sub>25/85</sub>	3435	3470	3320	3435	3435	3470	3530	3990

-40	70.749	74.483	106.390	117.915	235.831	248.277	256.536	401.860
-35	52.184	54.666	79.253	86.973	173.946	182.221	187.691	281.577
-30	38.975	40.636	59.757	64.958	129.917	135.452	139.097	200.204
-25	29.454	30.569	45.573	49.090	98.180	101.898	104.337	144.317
-20	22.507	23.257	35.130	37.511	75.022	77.523	79.157	105.385
-15	17.378	17.882	27.354	28.963	57.926	59.606	60.700	77.898
-10	13.550	13.887	21.503	22.584	45.168	46.290	47.019	58.246
-5	10.665	10.887	17.055	17.774	35.548	36.290	36.769	44.026
0	8.467	8.611	13.643	14.112	28.224	28.704	29.014	33.621
5	6.778	6.869	11.002	11.297	22.595	22.897	23.091	25.925
10	5.469	5.523	8.939	9.116	18.231	18.410	18.525	20.175
15	4.446	4.475	7.316	7.410	14.820	14.916	14.977	15.837
20	3.640	3.651	6.029	6.067	12.133	12.171	12.196	12.535
25	3.000	3.000	5.000	5.000	10.000	10.000	10.000	10.000
30	2.488	2.481	4.173	4.147	8.295	8.269	8.253	8.037
35	2.077	2.064	3.503	3.461	6.922	6.881	6.854	6.506
40	1.743	1.728	2.957	2.905	5.810	5.759	5.726	5.301
45	1.471	1.454	2.509	2.452	4.903	4.847	4.811	4.348
50	1.248	1.230	2.140	2.080	4.160	4.101	4.064	3.588
55	1.064	1.046	1.834	1.774	3.547	3.488	3.451	2.978
60	0.912	0.894	1.580	1.520	3.039	2.981	2.944	2.486
65	0.785	0.768	1.366	1.308	2.616	2.559	2.524	2.086
70	0.678	0.662	1.187	1.131	2.261	2.207	2.174	1.760
75	0.589	0.574	1.035	0.981	1.963	1.912	1.880	1.492
80	0.513	0.499	0.906	0.855	1.711	1.662	1.632	1.270
85	0.449	0.435	0.796	0.748	1.497	1.451	1.423	1.087
90	0.394	0.382	0.702	0.657	1.315	1.272	1.245	0.934
95	0.348	0.336	0.621	0.579	1.158	1.118	1.094	0.805
100	0.307	0.296	0.552	0.512	1.024	0.987	0.964	0.698
105	0.273	0.262	0.491	0.454	0.909	0.874	0.852	0.606
110	0.243	0.233	0.439	0.404	0.809	0.776	0.756	0.529
115	0.217	0.207	0.393	0.361	0.722	0.692	0.673	0.463
120	0.194	0.185	0.353	0.323	0.646	0.618	0.601	0.407

## NTC温度传感器阻温特性参考表(二)

## RESISTANCE-TEMP. CHARACTERISTIC TABLE OF COMMON SPEC.

单位Unit: KΩ

R(KΩ) t(°C)	50	50	50	100	100	100	500	500
B <sub>25/50</sub>	3950	4000	4050	3950	4050	4300	4150	4300
B <sub>25/85</sub>	3990	4050	4080	3990	4080	4410	4220	4410

-40								
-35								
-30								
-25	721.585	746.384	772.035					
-20	526.923	542.868	559.295					
-15	389.491	399.744	410.268					
-10	291.229	297.797	304.514					
-5	220.130	224.299	228.547					
0	168.103	170.703	173.343	336.206	346.687	374.340		
5	129.623	131.195	132.787	259.246	265.574	282.078		
10	100.873	101.773	102.681	201.746	205.362	214.690		
15	79.186	79.648	80.113	158.371	160.226	164.957	810.508	824.783
20	62.677	62.856	63.036	125.353	126.072	127.888	633.978	639.442
25	50.000	50.000	50.000	100.000	100.000	100.000	500.000	500.000
30	40.186	40.075	39.964	80.371	79.928	78.830	397.435	394.151
35	32.528	32.351	32.176	65.055	64.351	62.624	318.272	313.118
40	26.507	26.295	26.085	53.015	52.170	50.116	256.691	250.579
45	21.741	21.513	21.287	43.481	42.574	40.388	208.430	201.941
50	17.941	17.710	17.481	35.882	34.963	32.767	170.336	163.834
55	14.892	14.666	14.442	29.784	28.885	26.753	140.063	133.767
60	12.431	12.214	12.000	24.862	24.001	21.977	115.849	109.885
65	10.432	10.227	10.026	20.864	20.052	18.159	96.361	90.793
70	8.799	8.608	8.421	17.598	16.841	15.087	80.582	75.437
75	7.458	7.281	7.108	14.917	14.215	12.603	67.734	63.013
80	6.352	6.188	6.028	12.703	12.057	10.581	57.215	52.903
85	5.433	5.283	5.136	10.867	10.273	8.927	48.558	44.633
90	4.668	4.530	4.396	9.336	8.792	7.567	41.398	37.833
95	4.027	3.900	3.778	8.054	7.556	6.443	35.446	32.213
100	3.488	3.372	3.260	6.975	6.520	5.509	30.477	27.546
105	3.032	2.926	2.824	6.064	5.649	4.731	26.309	23.653
110	2.646	2.549	2.456	5.291	4.912	4.078	22.799	20.391
115	2.317	2.228	2.143	4.633	4.287	3.529	19.830	17.646
120	2.035	1.955	1.877	4.071	3.754	3.065	17.309	15.327





## NTC热敏电阻注意事项

请遵守以下事项，否则可能会造成NTC热敏电阻损坏、使用设备损伤或引起误动作。

- 1、请勿在使用温度范围以外使用。请勿施加超出使用温度范围上下限的急剧温度变化。
- 2、请在额定功率条件下使用NTC热敏电阻。各规格最大额定功率为 $\Phi 7-1.2W$ ， $\Phi 9-1.9 W$ ， $\Phi 11-2.3 W$ ， $\Phi 13-3 W$ ， $\Phi 15-3.5 W$ ， $\Phi 20-4 W$ 。请勿在绝缘部位和电极间施加过大的电压，否则，可能会产生绝缘不良现象。
- 3、将NTC热敏电阻作为设备的主控制元件使用时，如使用测温型NTC做温控传感器，为防止事故发生，请务必设置安全电路，比如同时使用双金属片控温，温度过冲时切断电源等周全的安全措施。
- 4、对于测温型NTC热敏电阻，由于自身发热导致电阻值下降时，用于测量环境温度时可能会引起温度检测精度降低，设备功能故障，故使用时请参考散热系数，注意NTC热敏电阻的外加功率及电压。
- 5、在高湿环境下使用护套型NTC热敏电阻时，应采取仅使护套封闭部分暴露于环境（水中、湿气）中，而护套开口部分不会直接接触水及蒸气的设计。
- 6、配线时应确保导线端部(含连接器)不会渗入水、蒸气、电解质液等，否则会造成接触不良。
- 7、请勿在腐蚀性气体的环境( $Cl_2$ 、 $NH_3$ 、 $SOX$ 、 $NOX$ )以及会接触到电解质液、盐水、酸、碱、有机溶剂的场所中使用。
- 8、请勿过度拉伸及弯曲导线。请勿施加过度的振动、冲击及压力。
- 9、金属腐蚀可能会造成设备功能故障，故在选择材质时，应确保金属护套型及螺钉紧固型NTC热敏电阻与安装的金属件之间不会产生接触电位差。
- 10、功率型NTC周围应避免安装发热和易燃元件，建议选用弯脚上部引线较高的产品，使NTC热敏电阻在线路板上高出其它元件，以免发热影响其它元件正常工作。
- 11、NTC热敏电阻是按不同用途分别进行设计的。设计设备时，请进行NTC热敏电阻使用评估试验，确认无异常后再使用。若用于规定以外的用途时，请就使用环境条件与本公司联系洽谈。
- 12、仓库存储条件，存储温度： $-10^{\circ}C \sim +40^{\circ}C$ ，相对湿度： $\leq 70\%RH$ ，不要将本产品存放在有腐蚀性气体或是阳光直接照射的环境中保管，存储期限：一年。

## PRECAUTION

In order to avoid the damage to NTC thermistor and equipment or the wrong operation, please pay attention to the following:

- 1、The HEL Thermistor shall not be operated outside the allowance operation temperature limits. Temperatures also shall not change dramatically while the thermistor is operated within the allowance operation temperature limits.
- 2、In order to avoid the bad insulation performance, The maximum rated zero power resistance for  $\Phi 7-1.2w$ ,  $\Phi 9-1.9 w$ ,  $\Phi 11-2.3 w$ ,  $\Phi 13-3 w$ ,  $\Phi 15-3.5 w$ ,  $\Phi 20-4 w$ . The HEL Thermistor shall not to be subjected by the overloaded power and overloaded voltage.
- 3、Please pay attention to the following while take the HEL NTC thermistor as main controlling element of the equipment. 1) In order to avoid the accident, please set the safety circuit while take the Temperature Control sensor as the main controlling element. 2) In the circuit that have the temperature control bimetal strip which has the same function as the NTC Thermistor, cut off the power while the temperature change dramatically.
- 4、In order to avoid causing the temperature test tolerance decreasing and failure equipment function, please refer to the heat-dissipating coefficient form while the resistance value declined caused by the self-heating in using the HEL NTC thermistor to measure the environmental temperature
- 5、While using the plastic wrapped NTC Thermistor in high humidity environment, please keep the opening of the plastic wrap away from the water and steam.
- 6、In order to avoid the poor contact please keep the lead wire or the connector away from water, steam and electrolytes liquid etc.
- 7、The HEL NTC Thermistor shall be free from the environment polluted by corrosive gas and solvent, such as  $Cl_2$ 、 $NH_3$ 、 $SOX$ 、 $NOX$ 、Electrolytes liquid, salty water etc.
- 8、Please do not stretching, bending, vibrating, shocking dramatically.
- 9、Please make sure that there will be no contact potential difference between the plastic wrapped NTC thermistor and the metalwork while selecting the accessory, because the corrosion of metal maybe cause the failure equipment function.
- 10、Do not place the heating and combustible component near the NTC thermistor, the longer length of the bending lead type NTC thermistor is recommended.
- 11、The HEL NTC Thermistor is designed according to the applications; please do the test and quality review before batch purchase. Please feel free to contact us if you need the customized products.
- 12、Storage Conditions of Products, Storage temperature: $-10^{\circ}C \sim +40^{\circ}C$ , Relative Humidity: $\leq 70\%RH$ , Do not store this product in corrosive gas or direct sunlight exposure, Shelf life:1year.



## 附录

### 参数定义

#### 热敏电阻器

其首要特性是随着阻体温度的变化，电阻值呈现显著变化的热敏感半导体电阻器。

#### 负温度系数热敏电阻器 (NTC)

温度升高时，电阻值下降的热敏电阻器。

#### 最大允许电容量

在负载状态下，与一个热敏电阻器连接的电容器的最大允许电容量值。

#### 剩余电阻值

当热敏电阻器上流过最大电流并达到热平衡时的直流电阻值。以欧姆 (Ω) 表示。

#### 冲击电流

比如已放电的电容器，已冷却的灯丝或者一个静止的马达等等，有极低的起始阻抗，当负载的初期有较高的初始电流称为冲击电流。

#### 零功率电阻

在规定温度下测得的热敏电阻器的直流电阻值。

#### 25°C环境温度下的最大电流

在25°C环境温度下，可以连续施加在热敏电阻器上的电流（直流或正弦波交流有效值）最大值。

#### 耗散系数

使热敏电阻器的温度升高1K所需消耗的功率。通常为规定的环境温度下功耗变化与热敏电阻器阻体温度变化之比。通常以 (mW/°C) 表示。

#### 热时间常数

在规定的介质中，热敏电阻器自热后冷却其温升的63.2%所需要的时间（单位为S）。

#### B值

NTC热敏电阻在某一温度之电阻与另一温度之电阻的比较值，可由下面的公式计算得到。材料常数是R1，R2 分别为 T1，T2 温度下的零功率电阻 T1 = 298.15 K(25°C) T2 = 323.15 K(50°C)

$$B = \ln(R1/R2) / (1/T1 - 1/T2)$$

#### 冲击能量

热敏电阻能承受最少6000次而电阻值变化率在±20%以内之冲击能量。此能量与所加之电压及电容值有关。

## APPENDIX

### PARAMETER DEFINITION

#### Thermistor

The primary characteristic of a thermally sensitive semiconductor resistor is with a significant change in resistance as the resistance body temperature changes.

#### Negative temperature coefficient

A thermistor exhibits a decrease in resistance when temperature rises.

#### Maximum allowable capacitance

The maximum allowable capacitance of a capacitor connected to a thermistor in a load state.

#### Residual resistance

The DC resistance when the maximum current is passed through the thermistor and the thermal balance is reached. Expressed in ohms (Ω).

#### Impact current

For example, a capacitor that has been discharged, a cooled filament, or a stationary motor, etc., has a very low initial impedance, and when the initial stage of the load has a higher initial current, it is called an impact current.

#### Zero-power resistance

The DC resistance of a thermistor measured at specified temperature.

#### Max. current at 25°C ambient temperature

At 25°C ambient temperature, the maximum value of current (DC or sinusoidal AC RMS) that can be applied continuously on a thermistor.

#### Dissipation factor

The power required to increase the temperature of a thermistor by 1K. it is the ratio of the change in power consumption to the temperature of the thermistor body at the specified ambient temperature. Expressed in mW/°C.

#### Thermal time constant

In a specified medium, the time required for the thermistor to cool its temperature rise by 63.2% after heating itself ( the unit is S )

#### B constant

$$B = \ln(R1/R2) / (1/T1 - 1/T2)$$

A comparison of the resistance of a NTC thermistor at a temperature to that of another, which can be calculated by the below formula. The material constants R1, R2 are zero-power resistances at T1 and T2 respectively. T1 = 298.15 K(25°C) T2 = 323.15 K(50°C)

$$B = \ln(R1/R2) / (1/T1 - 1/T2)$$

#### Impact energy

Thermistors can withstand impact energy at least 6000 times, while resistance rates change within ±20%. This energy is related to the added voltage and capacitance.