

Standard LDO Regulators

# Standard Fixed Output LDO Regulators with Shutdown Switch



BD33C0AWFP, BD50C0AWFP

No.11022EBT01

## ●Description

The BDXXC0AWFP Series is low-saturation regulator.

This IC has a built-in over-current protection circuit that prevents the destruction of the IC due to output short circuits and a thermal shutdown circuit that protects the IC from thermal damage due to overloading.

## ●Features

- 1) Output Current: 1A
- 2) Output Voltage: 3.3V / 5.0V
- 2) High Output Voltage Precision :  $\pm 1\%$
- 3) Low saturation with PDMOS output
- 4) Built-in over-current protection circuit that prevents the destruction of the IC due to output short circuits
- 5) Built-in thermal shutdown circuit for protecting the IC from thermal damage due to overloading
- 6) Low ESR Capacitor
- 7) TO252-5 packaging

## ●Applications

Audiovisual equipments, FPDs, televisions, personal computers or any other consumer device

## ●Absolute maximum ratings (Ta=25°C)

Parameter	Symbol	Ratings	Unit
Supply Voltage	V <sub>CC</sub>	-0.3 ~ +35.0	V
Output Control Voltage	V <sub>CTL</sub>	-0.3 ~ +35.0	V
Power Dissipation (TO252-5)	P <sub>d</sub>	1.3	W
Operating Temperature Range	T <sub>opr</sub>	-40 ~ +105	°C
Storage Temperature Range	T <sub>stg</sub>	-55 ~ +150	°C
Maximum Junction Temperature	T <sub>jmax</sub>	+150	°C

\*1 Not to exceed P<sub>d</sub>.

\*2 TO252-5:Reduced by 10.4mW / °C over Ta = 25°C, when mounted on glass epoxy board: 70mm × 70mm × 1.6mm.

NOTE : This product is not designed for protection against radioactive rays.

## ●Operating conditions (Ta=25°C)

Parameter	Symbol	Min.	Max.	Unit
Supply Voltage	V <sub>CC</sub>	V <sub>o</sub> +1V	26.5	V
Output Control Voltage	V <sub>CTL</sub>	0	26.5	V
Output Current	I <sub>o</sub>	0	1.0	A

## ● Electrical characteristics

■ BD33C0AWFP (Unless otherwise specified, Ta=25°C, Vcc=8.3V, VCTL=5V, Io=0mA)

Parameter	Symbol	Min.	Typ.	Max.	Unit	Conditions
Shut Down Current	I <sub>sd</sub>	—	0	10	μA	V <sub>CTL</sub> =0V
Bias Current	I <sub>b</sub>	—	0.5	1.0	mA	
Output Voltage	V <sub>o</sub>	3.267	3.300	3.333	V	I <sub>o</sub> =200mA
Dropout Voltage	ΔV <sub>d</sub>	—	0.4	0.7	V	V <sub>cc</sub> =V <sub>o</sub> × 0.95, I <sub>o</sub> =500mA
Ripple Rejection	R.R.	45	55	—	dB	f=120Hz, e <sub>in</sub> <sup>*1</sup> =1V <sub>rms</sub> , I <sub>o</sub> =100mA
Line Regulation	Reg.I	—	20	60	mV	V <sub>o</sub> +1V→25V
Load Regulation	Reg.L	—	V <sub>o</sub> × 0.010	V <sub>o</sub> × 0.020	V	I <sub>o</sub> =5mA→1A
Temperature Coefficient of Output Voltage	Tcvo.1	—	+0.04	—	%/°C	I <sub>o</sub> =5mA, T <sub>j</sub> =-40~-20°C
	Tcvo.2	—	±0.005	—	%/°C	I <sub>o</sub> =5mA, T <sub>j</sub> =-20~+105°C
CTL ON Mode Voltage	V <sub>thH</sub>	2.0	—	—	V	ACTIVE MODE
CTL OFF Mode Voltage	V <sub>thL</sub>	—	—	0.8	V	OFF MODE
CTL Bias Current	I <sub>CTL</sub>	—	25	50	μA	

\*1 e<sub>in</sub> : Input Voltage Ripple

■ BD50C0AWFP (Unless otherwise specified, Ta=25°C, Vcc=10V, VCTL=5V, Io=0mA)

Parameter	Symbol	Min.	Typ.	Max.	Unit	Conditions
Shut Down Current	I <sub>sd</sub>	—	0	10	μA	V <sub>CTL</sub> =0V
Bias Current	I <sub>b</sub>	—	0.5	1.0	mA	
Output Voltage	V <sub>o</sub>	4.950	5.000	5.050	V	I <sub>o</sub> =200mA
Dropout Voltage	ΔV <sub>d</sub>	—	0.3	0.5	V	V <sub>cc</sub> =V <sub>o</sub> × 0.95, I <sub>o</sub> =500mA
Ripple Rejection	R.R.	45	55	—	dB	f=120Hz, e <sub>in</sub> <sup>*1</sup> =1V <sub>rms</sub> , I <sub>o</sub> =100mA
Line Regulation	Reg.I	—	20	60	mV	V <sub>o</sub> +1V→25V
Load Regulation	Reg.L	—	V <sub>o</sub> × 0.010	V <sub>o</sub> × 0.020	V	I <sub>o</sub> =5mA→1A
Temperature Coefficient of Output Voltage	Tcvo.1	—	+0.04	—	%/°C	I <sub>o</sub> =5mA, T <sub>j</sub> =-40~-20°C
	Tcvo.2	—	±0.005	—	%/°C	I <sub>o</sub> =5mA, T <sub>j</sub> =-20~+105°C
CTL ON Mode Voltage	V <sub>thH</sub>	2.0	—	—	V	ACTIVE MODE
CTL OFF Mode Voltage	V <sub>thL</sub>	—	—	0.8	V	OFF MODE
CTL Bias Current	I <sub>CTL</sub>	—	25	50	μA	

\*1 e<sub>in</sub> : Input Voltage Ripple

●Electrical characteristic curves (Reference data)

■BD33C0AWFP (Unless otherwise specified,  $T_a=25^\circ\text{C}$ ,  $V_{cc}=8.3\text{V}$ ,  $V_{CTL}=5\text{V}$ ,  $I_o=0\text{mA}$ )

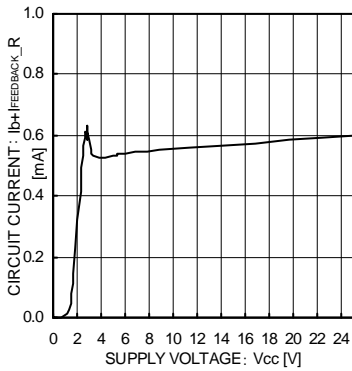

Fig.1 Circuit Current

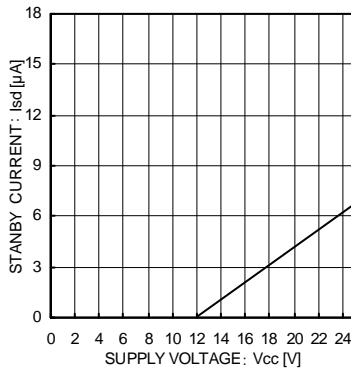

Fig.2 Shut Down Current

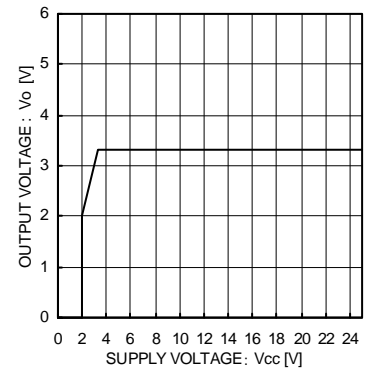

Fig.3 Line Regulation  
( $I_o=0\text{mA}$ )

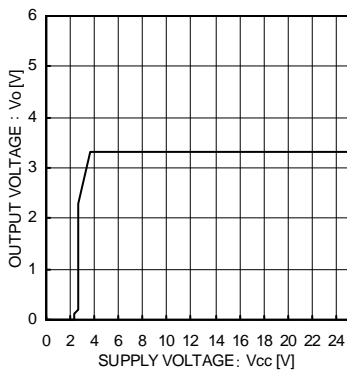

Fig.4 Line Regulation  
( $I_o=500\text{mA}$ )

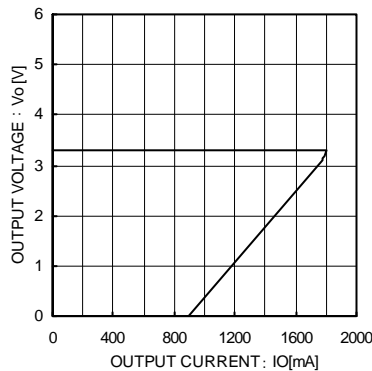

Fig.5 Load Regulation

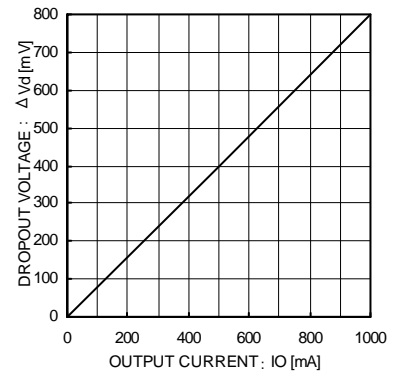

Fig.6 Dropout Voltage  
( $V_{cc}=V_o \times 0.95\text{V}$ )  
( $I_o=0\text{mA} \rightarrow 1000\text{mA}$ )

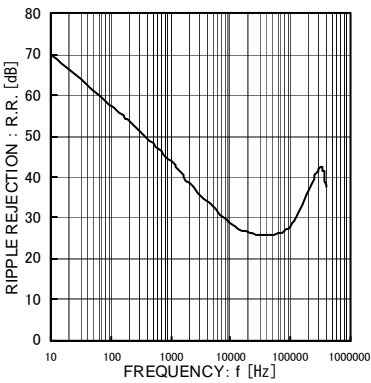

Fig.7 Ripple Rejection  
( $I_o=100\text{mA}$ )

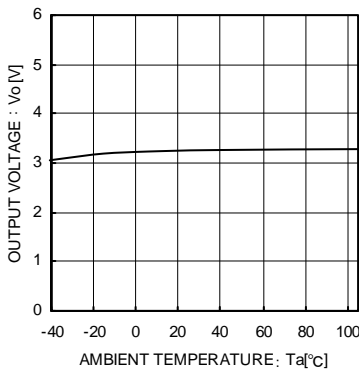

Fig.8 Output Voltage  
Temperature Characteristics

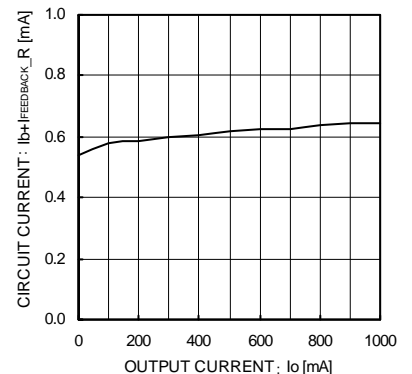

Fig.9 Circuit Current  
( $I_o=0\text{mA} \rightarrow 1000\text{mA}$ )

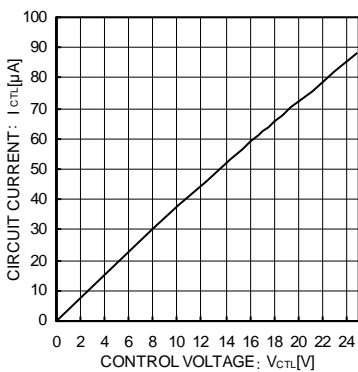

Fig.10 CTL Voltage vs CTL Current

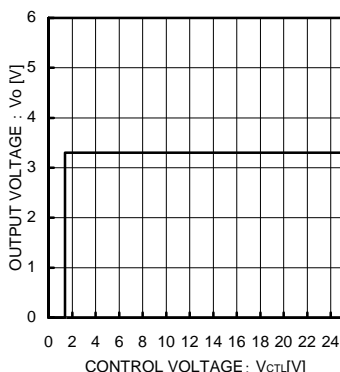

Fig.11 CTL Voltage vs Output Voltage

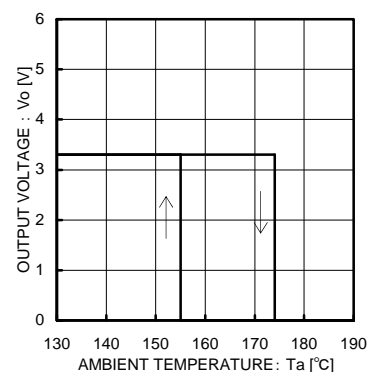

Fig.12 Thermal Shutdown  
Circuit Characteristics

●Electrical characteristic curves (Reference data)

■BD50C0AWFP (Unless otherwise specified,  $T_a=25^{\circ}\text{C}$ ,  $V_{cc}=10\text{V}$ ,  $V_{CTL}=5\text{V}$ ,  $I_o=0\text{mA}$ )

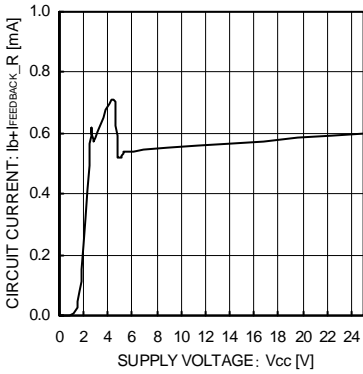

Fig.13 Circuit Current

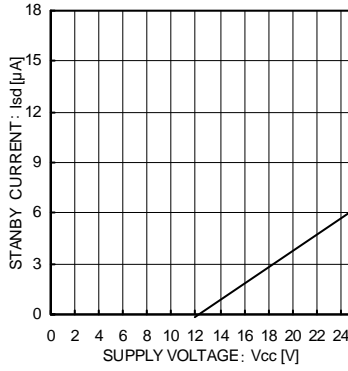

Fig.14 Shut Down Current

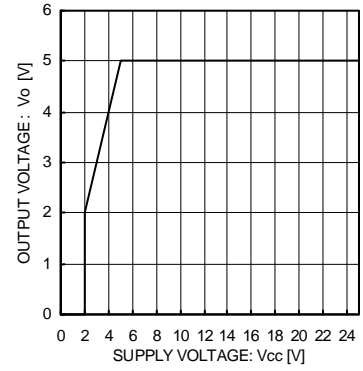

Fig.15 Line Regulation ( $I_o=0\text{mA}$ )

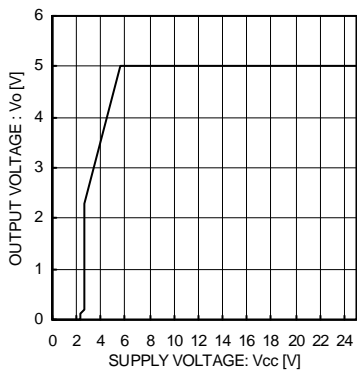

Fig.16 Line Regulation ( $I_o=500\text{mA}$ )

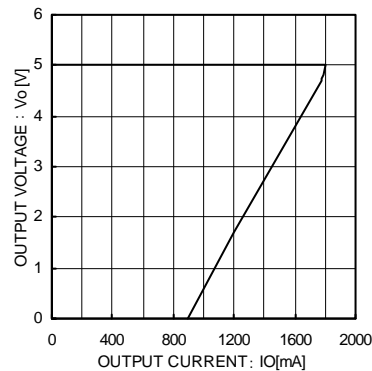

Fig.17 Load Regulation

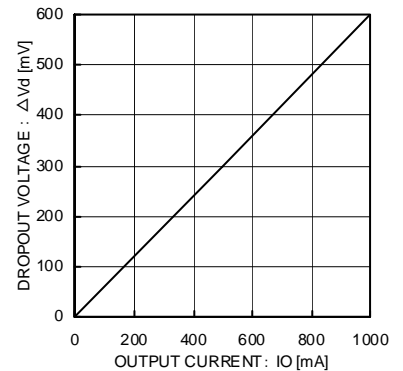

Fig.18 Dropout Voltage ( $V_{cc}=V_o \times 0.95\text{V}$ ,  $I_o=0\text{mA} \rightarrow 1000\text{mA}$ )

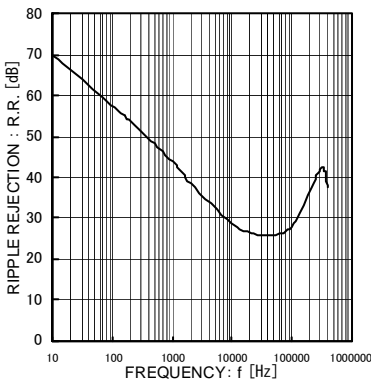

Fig.19 Ripple Rejection ( $I_o=100\text{mA}$ )

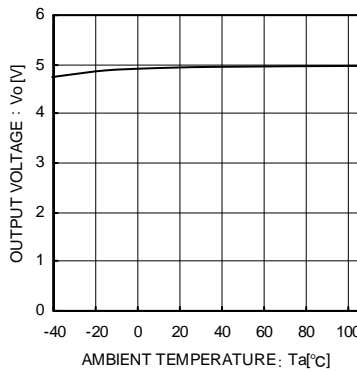

Fig.20 Output Voltage Temperature Characteristics

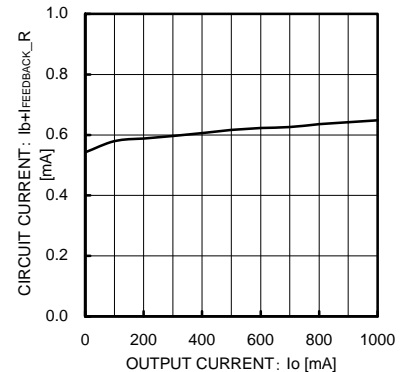

Fig.21 Circuit Current ( $I_o=0\text{mA} \rightarrow 1000\text{mA}$ )

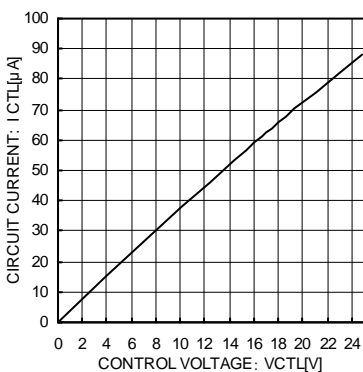

Fig.22 CTL Voltage vs CTL Current

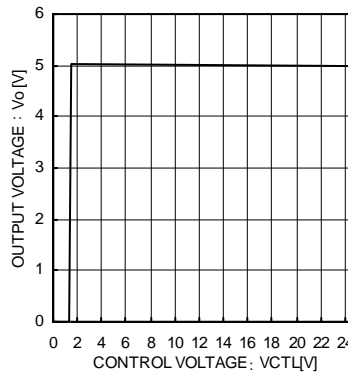

Fig.23 CTL Voltage vs Output Voltage

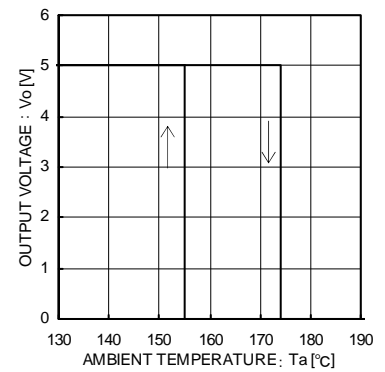
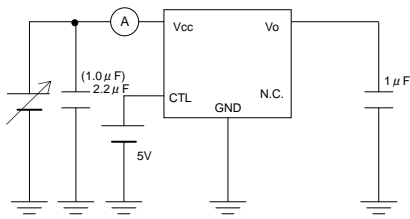

Fig.24 Thermal Shutdown Circuit Characteristics

● Measurement circuit for reference data Measurement circuit for reference data

■ BDXXC0AWFP ( ):  $V_o=5.0V$



Measurement Circuit of Fig.1 and Fig.13

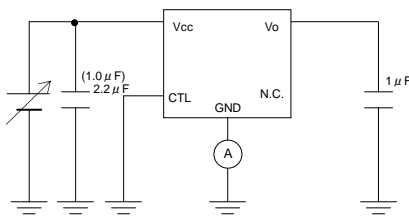

Measurement Circuit of Fig.2 and Fig.14

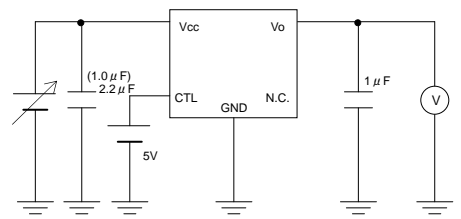

Measurement Circuit of Fig.3 and Fig.15

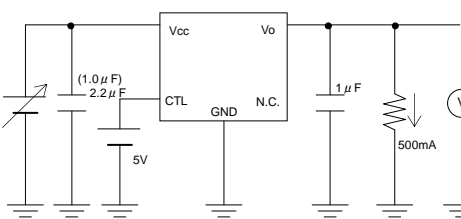

Measurement Circuit of Fig.4 and Fig.16

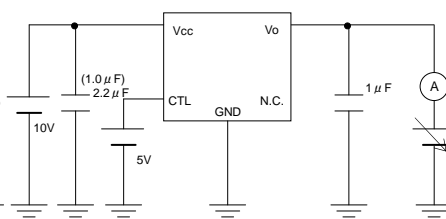

Measurement Circuit of Fig.5 and Fig.17

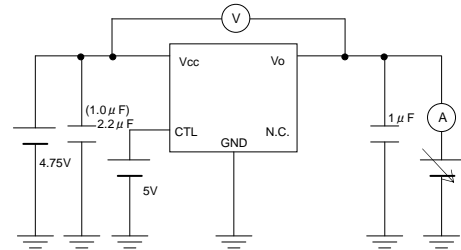

Measurement Circuit of Fig.6 and Fig.18

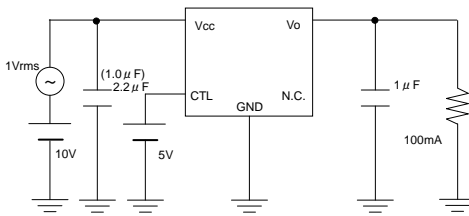

Measurement Circuit of Fig.7 and Fig.19

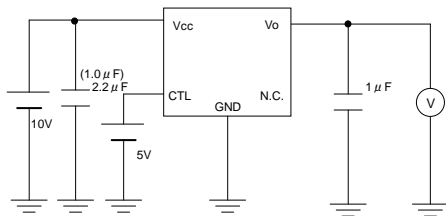

Measurement Circuit of Fig.8 and Fig.20

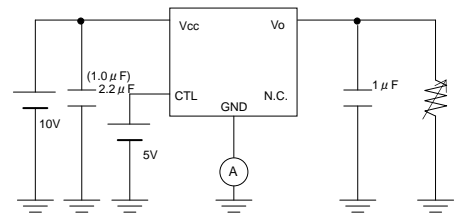

Measurement Circuit of Fig.9 and Fig.21

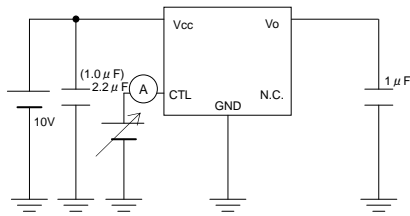

Measurement Circuit of Fig.10 and Fig.22

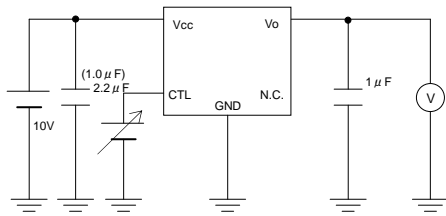

Measurement Circuit of Fig.11 and Fig.23

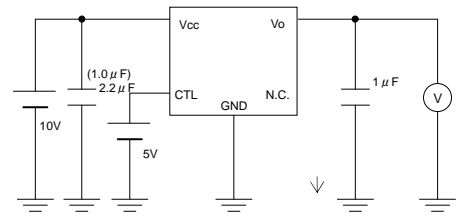

Measurement Circuit of Fig.12 and Fig.24

●Block Diagrams

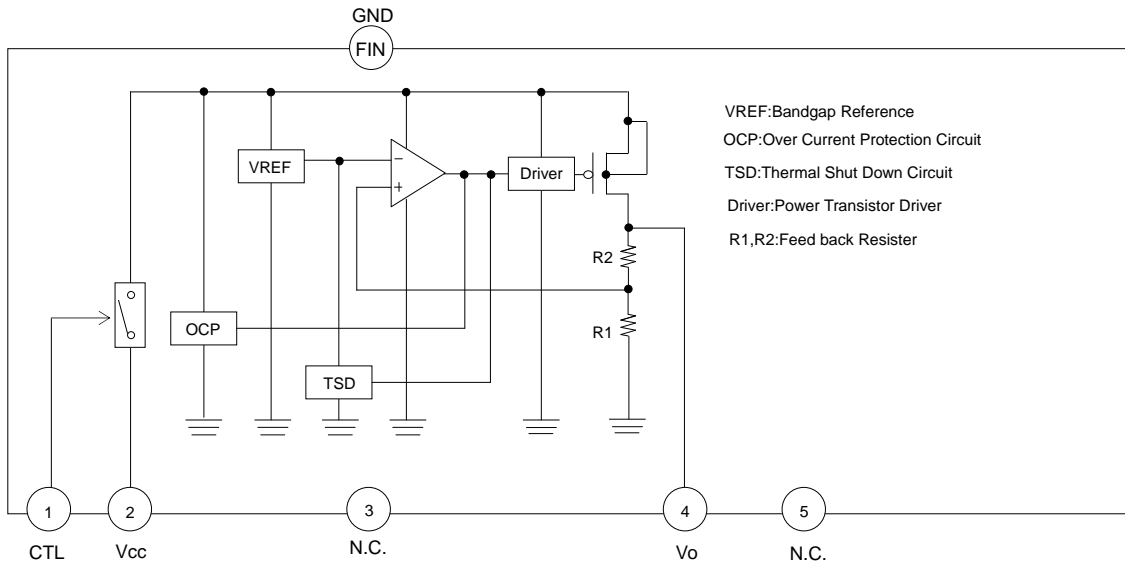
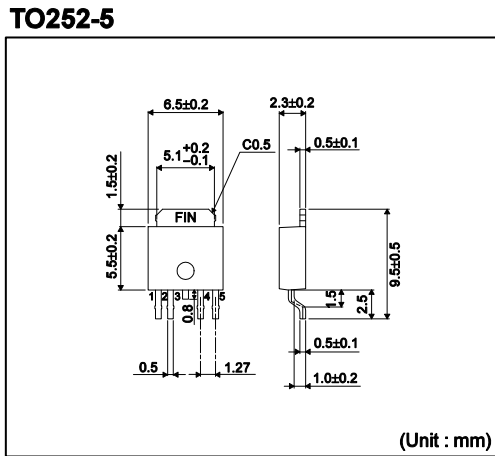

Fig.25

Pin No.	Pin Name	Function
1	CTL	Output Control Pin
2	Vcc	Power Supply Pin
3	N.C.	N.C. Pin
4	Vo	Output Pin
5	N.C.	N.C. Pin
Fin	GND	GND

●TOP VIEW (Package dimension)



● Input / Output Equivalent Circuit Diagrams

Vcc Pin

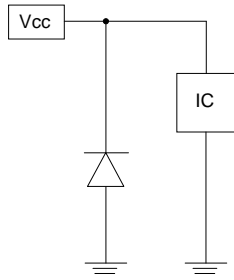

CTL Pin

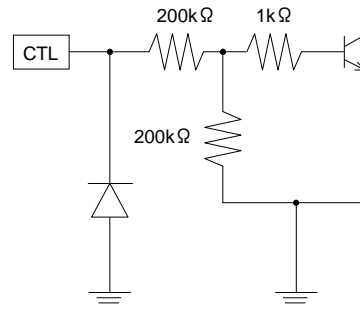

Vo Pin

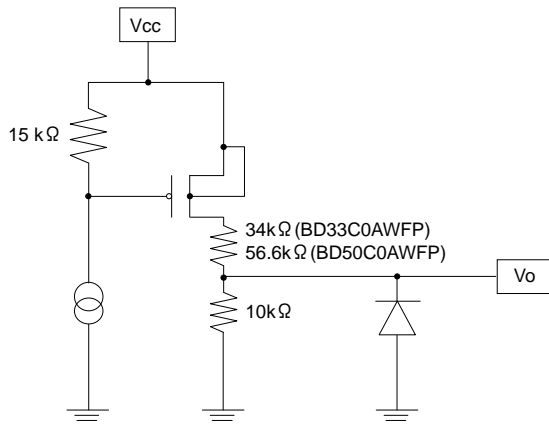

●Thermal Design

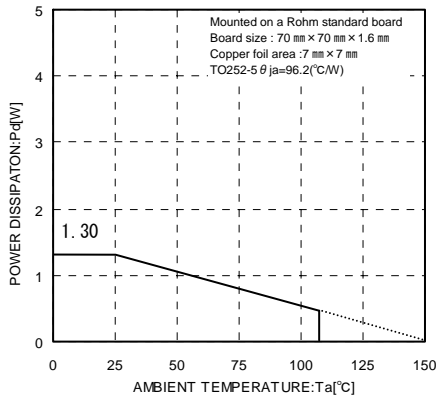

Fig.26

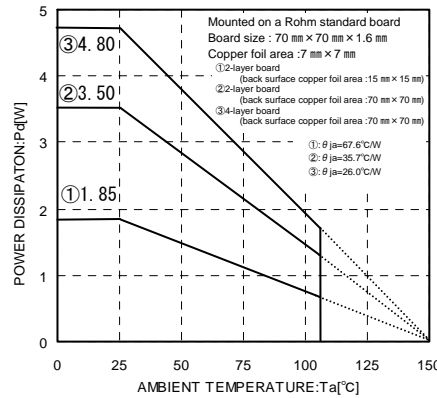

Fig.27(Reference data)

When using at temperatures over  $T_a=25^{\circ}\text{C}$ , please refer to the heat reducing characteristics shown in Fig.26 and Fig.27. The IC characteristics are closely related to the temperature at which the IC is used, so it is necessary to operate the IC at temperatures less than the maximum junction temperature  $T_{j\text{max}}$ .

Fig.26 and Fig.27 show the acceptable loss and heat reducing characteristics of the TO252-5 package. Even when the ambient temperature  $T_a$  is a normal temperature ( $25^{\circ}\text{C}$ ), the chip (junction) temperature  $T_j$  may be quite high so please operate the IC at temperatures less than the acceptable loss  $P_d$ .

The calculation method for power consumption  $P_c(\text{W})$  is as follows : (Fig.27③)

$$P_c = (V_{cc} - V_o) \times I_o + V_{cc} \times I_b$$

$$\text{Acceptable loss } P_d \geq P_c$$

Solving this for load current  $I_o$  in order to operate within the acceptable loss,

$$I_o \leq \frac{P_d - V_{cc} \times I_b}{V_{cc} - V_o} \quad (\text{Please refer to Fig.9,21 for } I_b.)$$

$V_{cc}$ : Input voltage  
 $V_o$ : Output voltage  
 $I_o$ : Load current  
 $I_b$ : Circuit current  
 $I_{\text{short}}$ : Short current

It is then possible to find the maximum load current  $I_{o\text{max}}$  with respect to the applied voltage  $V_{cc}$  at the time of thermal design.

Calculation Example) When  $T_a=85^{\circ}\text{C}$

BD33C0AWFP:  $V_{cc}=8.3\text{V}, V_o=3.3\text{V}$     BD50C0AWFP:  $V_{cc}=10\text{V}, V_o=5.0\text{V}$

$$I_o \leq \frac{2.496 - 10 \times I_b}{5} \quad \left[ \begin{array}{l} \text{Fig.27③: } \theta_{ja}=26.0^{\circ}\text{C/W} \rightarrow -38.4\text{mW}/^{\circ}\text{C} \\ 25^{\circ}\text{C}=4.80\text{W} \rightarrow 85^{\circ}\text{C}=2.496\text{W} \end{array} \right]$$

$$I_o \leq 498.2\text{mA} \quad (I_b: 0.5\text{mA})$$

Please refer to the above information and keep thermal designs within the scope of acceptable loss for all operating temperature ranges. The power consumption  $P_c$  of the IC when there is a short circuit (short between  $V_o$  and GND) is :

$$P_c = V_{cc} \times (I_b + I_{\text{short}}) \quad (\text{Please refer to Fig.5,17 for } I_{\text{short}}.)$$



## ●Notes for use

1. Absolute maximum ratings  
Use of the IC in excess of absolute maximum ratings (such as the input voltage or operating temperature range) may result in damage to the IC. Assumptions should not be made regarding the state of the IC (e.g., short mode or open mode) when such damage is suffered. If operational values are expected to exceed the maximum ratings for the device, consider adding protective circuitry (such as fuses) to eliminate the risk of damaging the IC.
2. Electrical characteristics described in these specifications may vary, depending on temperature, supply voltage, external circuits and other conditions. Therefore, be sure to check all relevant factors, including transient characteristics.
3. GND potential  
The potential of the GND pin must be the minimum potential in the system in all operating conditions. Ensure that no pins are at a voltage below the GND at any time, regardless of transient characteristics.
4. Ground wiring pattern  
When using both small-signal and large-current GND traces, the two ground traces should be routed separately but connected to a single ground potential within the application in order to avoid variations in the small-signal ground caused by large currents. Also ensure that the GND traces of external components do not cause variations on GND voltage. The power supply and ground lines must be as short and thick as possible to reduce line impedance.
5. Inter-pin shorts and mounting errors  
Use caution when orienting and positioning the IC for mounting on printed circuit boards. Improper mounting may result in damage to the IC. Shorts between output pins or between output pins and the power supply or GND pins (caused by poor soldering or foreign objects) may result in damage to the IC.
6. Operation in strong electromagnetic fields  
Using this product in strong electromagnetic fields may cause IC malfunction. Caution should be exercised in applications where strong electromagnetic fields may be present.
7. Testing on application boards  
When testing the IC on an application board, connecting a capacitor directly to a low-impedance pin may subject the IC to stress. Always discharge capacitors completely after each process or step. The IC's power supply should always be turned off completely before connecting or removing it from a jig or fixture during the evaluation process. To prevent damage from static discharge, ground the IC during assembly and use similar precautions during transport and storage.
8. Thermal consideration  
Use a thermal design that allows for a sufficient margin in light of the Pd in actual operating conditions. Consider Pc that does not exceed Pd in actual operating conditions. ( $P_d \geq P_c$ )

$$\left( \begin{array}{l} T_{jmax} : \text{Maximum junction temperature} = 150^{\circ}\text{C}, T_a : \text{Peripheral temperature} [^{\circ}\text{C}], \\ \theta_{ja} : \text{Thermal resistance of package-ambience} [^{\circ}\text{C}/\text{W}], P_d : \text{Package Power dissipation} [\text{W}], \\ P_c : \text{Power dissipation} [\text{W}], V_{cc} : \text{Input Voltage}, V_o : \text{Output Voltage}, I_o : \text{Load}, I_b : \text{Bias Current} \end{array} \right)$$

$$\text{Package Power dissipation} \quad : P_d (\text{W}) = (T_{jmax} - T_a) / \theta_{ja}$$

$$\text{Power dissipation} \quad : P_c (\text{W}) = (V_{cc} - V_o) \times I_o + V_{cc} \times I_b$$

9. Vcc pin  
Insert a capacitor ( $V_o \geq 5\text{V}$ : capacitor  $\geq 1\mu\text{F}$  ~,  $V_o < 5\text{V}$ : capacitor  $\geq 2.2\mu\text{F}$  ~) between the Vcc and GND pins. The appropriate capacitance value varies by application. Be sure to allow a sufficient margin for input voltage levels.

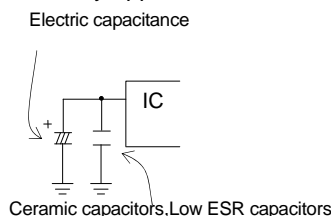

## 10. Output pin

It is necessary to place capacitors between each output pin and GND to prevent oscillation on the output. Usable capacitance values range from 1 $\mu$ F to 1000 $\mu$ F. Ceramic capacitors can be used as long as their ESR value is low enough to prevent oscillation (0.001 $\Omega$  to 20 $\Omega$ ). Abrupt fluctuations in input voltage and load conditions may affect the output voltage. Output capacitance values should be determined only through sufficient testing of the actual application.

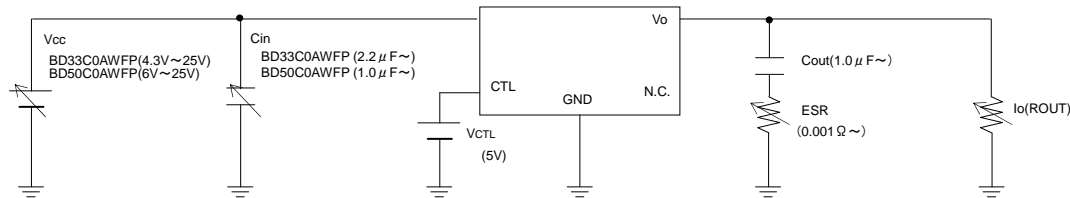
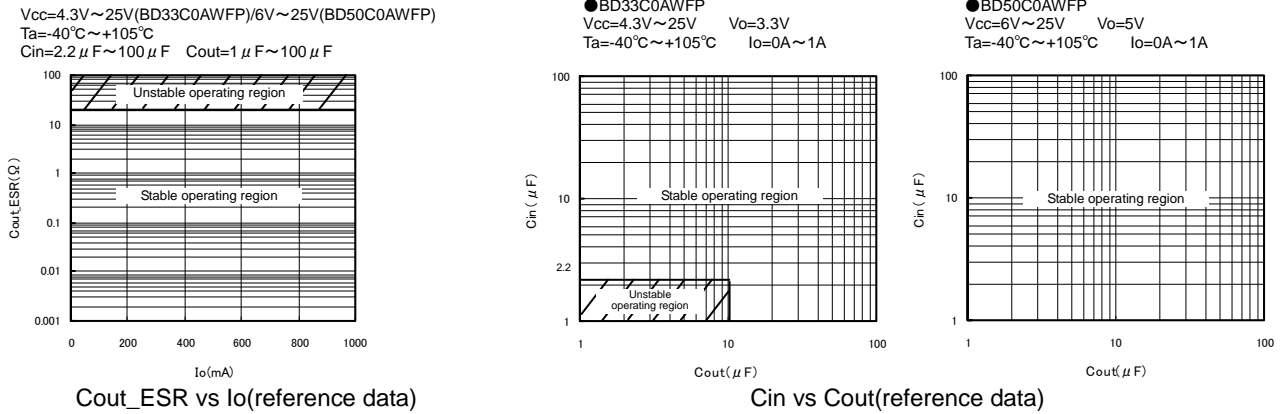

※Operation Notes 10 Measurement circuit

## 11. CTL pin

Do not make voltage level of chip enable pin keep floating level, or in between  $V_{thH}$  and  $V_{thL}$ . Otherwise, the output voltage would be unstable or indefinite.

12. For a steep change of the  $V_{CC}$  voltage

Because MOS FET for output Transistor is used when an input voltage change is very steep, it may evoke large current. When selecting the value of external circuit constants, please make sure that the operation on the actual application takes these conditions into account.

## 13. For an infinitesimal fluctuations of output voltage.

At the use of the application that infinitesimal fluctuations of output voltage caused by some factors (e.g. disturbance noise, input voltage fluctuations, load fluctuations, etc.), please take enough measures to avoid some influence (e.g. insert the filter, etc.).

## 14. Over current protection circuit (OCP)

The IC incorporates an integrated over-current protection circuit that operates in accordance with the rated output capacity. This circuit serves to protect the IC from damage when the load becomes shorted. It is also designed to limit output current (without latching) in the event of a large and instantaneous current flow from a large capacitor or other component. These protection circuits are effective in preventing damage due to sudden and unexpected accidents. However, the IC should not be used in applications characterized by the continuous or transitive operation of the protection circuits.

## 15. Thermal shutdown circuit (TSD)

The IC incorporates a built-in thermal shutdown circuit, which is designed to turn the IC off completely in the event of thermal overload. It is not designed to protect the IC from damage or guarantee its operation. ICs should not be used after this function has activated, or in applications where the operation of this circuit is assumed.

16. Applications or inspection processes where the potential of the Vcc pin or other pins may be reversed from their normal state may cause damage to the IC's internal circuitry or elements. Use an output pin capacitance of 1000µF or lower in case Vcc is shorted with the GND pin while the external capacitor is charged. Insert a diode in series with Vcc to prevent reverse current flow, or insert bypass diodes between Vcc and each pin.

17. Positive voltage surges on VCC pin  
A power zener diode should be inserted between VCC and GND for protection against voltage surges of more than 35V on the VCC pin.

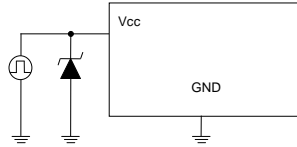

18. Negative voltage surges on VCC pin  
A schottky barrier diode should be inserted between VCC and GND for protection against voltages lower than GND on the VCC pin.

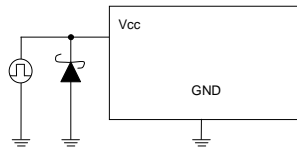

19. Output protection diode  
Loads with large inductance components may cause reverse current flow during startup or shutdown. In such cases, a protection diode should be inserted on the output to protect the IC.

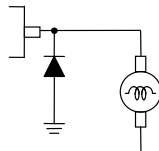

20. Regarding input pins of the IC  
This monolithic IC contains P+ isolation and P substrate layers between adjacent elements in order to keep them isolated. PN junctions are formed at the intersection of these P layers with the N layers of other elements, creating parasitic diodes and/or transistors. For example (refer to the figure below):

○When GND > Pin A and GND > Pin B, the PN junction operates as a parasitic diode

○When GND > Pin B, the PN junction operates as a parasitic transistor

Parasitic diodes occur inevitably in the structure of the IC, and the operation of these parasitic diodes can result in mutual interference among circuits, operational faults, or physical damage. Accordingly, conditions that cause these diodes to operate, such as applying a voltage lower than the GND voltage to an input pin (and thus to the P substrate) should be avoided.

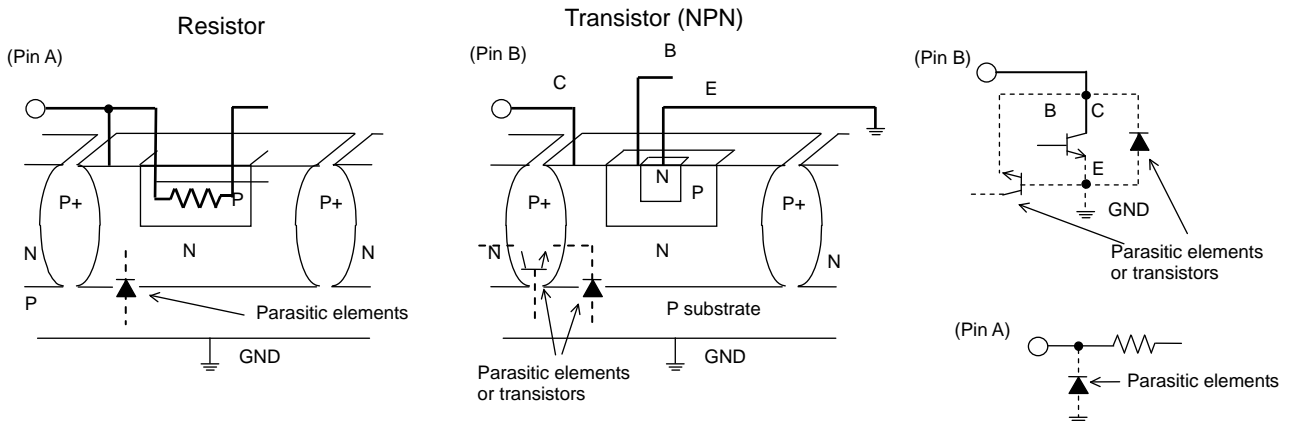

Example of Simple Monolithic IC Architecture

●Ordering part number

B	D	X	X	C	0	A	W	F	P	-	E	2
Part No.		Output voltage 33: 3.3V output 50:5.0V~		Current capacity COA:Output 1A			Shutdown switch W : With switch None : Without switch	Package FP : TO252		Packaging specification E2: Embossed tape and reel		

**TO252-5**

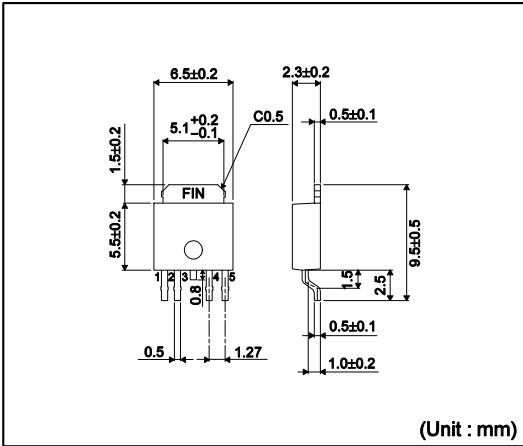

**<Tape and Reel information>**

Tape	Embossed carrier tape
Quantity	2000pcs
Direction of feed	E2 ( The direction is the 1pin of product is at the lower left when you hold reel on the left hand and you pull out the tape on the right hand )

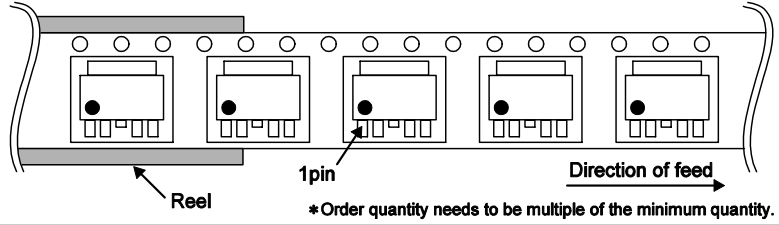

# Notice

## Precaution on using ROHM Products

- Our Products are designed and manufactured for application in ordinary electronic equipments (such as AV equipment, OA equipment, telecommunication equipment, home electronic appliances, amusement equipment, etc.). If you intend to use our Products in devices requiring extremely high reliability (such as medical equipment <sup>(Note 1)</sup>, transport equipment, traffic equipment, aircraft/spacecraft, nuclear power controllers, fuel controllers, car equipment including car accessories, safety devices, etc.) and whose malfunction or failure may cause loss of human life, bodily injury or serious damage to property ("Specific Applications"), please consult with the ROHM sales representative in advance. Unless otherwise agreed in writing by ROHM in advance, ROHM shall not be in any way responsible or liable for any damages, expenses or losses incurred by you or third parties arising from the use of any ROHM's Products for Specific Applications.

(Note1) Medical Equipment Classification of the Specific Applications

JAPAN	USA	EU	CHINA
CLASS III	CLASS III	CLASS II b	CLASS III
CLASS IV		CLASS III	

- ROHM designs and manufactures its Products subject to strict quality control system. However, semiconductor products can fail or malfunction at a certain rate. Please be sure to implement, at your own responsibilities, adequate safety measures including but not limited to fail-safe design against the physical injury, damage to any property, which a failure or malfunction of our Products may cause. The following are examples of safety measures:
  - Installation of protection circuits or other protective devices to improve system safety
  - Installation of redundant circuits to reduce the impact of single or multiple circuit failure
- Our Products are designed and manufactured for use under standard conditions and not under any special or extraordinary environments or conditions, as exemplified below. Accordingly, ROHM shall not be in any way responsible or liable for any damages, expenses or losses arising from the use of any ROHM's Products under any special or extraordinary environments or conditions. If you intend to use our Products under any special or extraordinary environments or conditions (as exemplified below), your independent verification and confirmation of product performance, reliability, etc. prior to use, must be necessary:
  - Use of our Products in any types of liquid, including water, oils, chemicals, and organic solvents
  - Use of our Products outdoors or in places where the Products are exposed to direct sunlight or dust
  - Use of our Products in places where the Products are exposed to sea wind or corrosive gases, including Cl<sub>2</sub>, H<sub>2</sub>S, NH<sub>3</sub>, SO<sub>2</sub>, and NO<sub>2</sub>
  - Use of our Products in places where the Products are exposed to static electricity or electromagnetic waves
  - Use of our Products in proximity to heat-producing components, plastic cords, or other flammable items
  - Sealing or coating our Products with resin or other coating materials
  - Use of our Products without cleaning residue of flux (even if you use no-clean type fluxes, cleaning residue of flux is recommended); or Washing our Products by using water or water-soluble cleaning agents for cleaning residue after soldering
  - Use of the Products in places subject to dew condensation
- The Products are not subject to radiation-proof design.
- Please verify and confirm characteristics of the final or mounted products in using the Products.
- In particular, if a transient load (a large amount of load applied in a short period of time, such as pulse. is applied, confirmation of performance characteristics after on-board mounting is strongly recommended. Avoid applying power exceeding normal rated power; exceeding the power rating under steady-state loading condition may negatively affect product performance and reliability.
- De-rate Power Dissipation (Pd) depending on Ambient temperature (Ta). When used in sealed area, confirm the actual ambient temperature.
- Confirm that operation temperature is within the specified range described in the product specification.
- ROHM shall not be in any way responsible or liable for failure induced under deviant condition from what is defined in this document.

## Precaution for Mounting / Circuit board design

- When a highly active halogenous (chlorine, bromine, etc.) flux is used, the residue of flux may negatively affect product performance and reliability.
- In principle, the reflow soldering method must be used; if flow soldering method is preferred, please consult with the ROHM representative in advance.

For details, please refer to ROHM Mounting specification

### Precautions Regarding Application Examples and External Circuits

1. If change is made to the constant of an external circuit, please allow a sufficient margin considering variations of the characteristics of the Products and external components, including transient characteristics, as well as static characteristics.
2. You agree that application notes, reference designs, and associated data and information contained in this document are presented only as guidance for Products use. Therefore, in case you use such information, you are solely responsible for it and you must exercise your own independent verification and judgment in the use of such information contained in this document. ROHM shall not be in any way responsible or liable for any damages, expenses or losses incurred by you or third parties arising from the use of such information.

### Precaution for Electrostatic

This Product is electrostatic sensitive product, which may be damaged due to electrostatic discharge. Please take proper caution in your manufacturing process and storage so that voltage exceeding the Products maximum rating will not be applied to Products. Please take special care under dry condition (e.g. Grounding of human body / equipment / solder iron, isolation from charged objects, setting of Ionizer, friction prevention and temperature / humidity control).

### Precaution for Storage / Transportation

1. Product performance and soldered connections may deteriorate if the Products are stored in the places where:
  - [a] the Products are exposed to sea winds or corrosive gases, including Cl<sub>2</sub>, H<sub>2</sub>S, NH<sub>3</sub>, SO<sub>2</sub>, and NO<sub>2</sub>
  - [b] the temperature or humidity exceeds those recommended by ROHM
  - [c] the Products are exposed to direct sunshine or condensation
  - [d] the Products are exposed to high Electrostatic
2. Even under ROHM recommended storage condition, solderability of products out of recommended storage time period may be degraded. It is strongly recommended to confirm solderability before using Products of which storage time is exceeding the recommended storage time period.
3. Store / transport cartons in the correct direction, which is indicated on a carton with a symbol. Otherwise bent leads may occur due to excessive stress applied when dropping of a carton.
4. Use Products within the specified time after opening a humidity barrier bag. Baking is required before using Products of which storage time is exceeding the recommended storage time period.

### Precaution for Product Label

QR code printed on ROHM Products label is for ROHM's internal use only.

### Precaution for Disposition

When disposing Products please dispose them properly using an authorized industry waste company.

### Precaution for Foreign Exchange and Foreign Trade act

Since our Products might fall under controlled goods prescribed by the applicable foreign exchange and foreign trade act, please consult with ROHM representative in case of export.

### Precaution Regarding Intellectual Property Rights

1. All information and data including but not limited to application example contained in this document is for reference only. ROHM does not warrant that foregoing information or data will not infringe any intellectual property rights or any other rights of any third party regarding such information or data. ROHM shall not be in any way responsible or liable for infringement of any intellectual property rights or other damages arising from use of such information or data.:
2. No license, expressly or implied, is granted hereby under any intellectual property rights or other rights of ROHM or any third parties with respect to the information contained in this document.

### Other Precaution

1. This document may not be reprinted or reproduced, in whole or in part, without prior written consent of ROHM.
2. The Products may not be disassembled, converted, modified, reproduced or otherwise changed without prior written consent of ROHM.
3. In no event shall you use in any way whatsoever the Products and the related technical information contained in the Products or this document for any military purposes, including but not limited to, the development of mass-destruction weapons.
4. The proper names of companies or products described in this document are trademarks or registered trademarks of ROHM, its affiliated companies or third parties.

**General Precaution**

1. Before you use our Products, you are requested to carefully read this document and fully understand its contents. ROHM shall not be in any way responsible or liable for failure, malfunction or accident arising from the use of any ROHM's Products against warning, caution or note contained in this document.
2. All information contained in this document is current as of the issuing date and subject to change without any prior notice. Before purchasing or using ROHM's Products, please confirm the latest information with a ROHM sales representative.
3. The information contained in this document is provided on an "as is" basis and ROHM does not warrant that all information contained in this document is accurate and/or error-free. ROHM shall not be in any way responsible or liable for any damages, expenses or losses incurred by you or third parties resulting from inaccuracy or errors of or concerning such information.