

PRODUCT SPECIFICATION

新弘智

SPEC. NO: T-0602-015H

DATE: Nov. 27, 2018

CUSTOMER' S PRODUCT NAME:

EMTEK PRODUCT NAME:

CMF3216F-M Series

THIS SPECIFICATION IS:

- FULLY ACCEPTED
 DENIED
 ACCEPTED UNDER THE FOLLOWING CONDITIONS



SIGNATURE: _____

DATE: _____

NAME(PRINT): _____

TITLE: _____



EMTEK CO., LTD.

本文件內容全部或部份,未經兆欣科技股份有限公司同意不得以任何形式複製或其他用途
All rights reserved.This document or parts thereof,may not be reproduced by any means or used in any manner without written permission of EMTEK CO.,LTD.

FACTORY:

39, Chingao Rd., (305)Hsinpu,
Hsinchu Hsien, Taiwan, R. O. C
TEL: 03-5894-433
FAX: 03-5894-523

PRODUCT SPECIFICATION

SPEC. NO.
T-0602-015H



1. Scope

This specification applies ferrite Chip common mode filters CMF3216F-M Series to be delivered to user

2. Product Identification

CMF 3216 F - 900 M - 2P - T
(1) (2) (3) (4) (5) (6) (7)

- (1) Product name
- (2) Shapes and dimensions
- (3) Shielding Type
- (4) Impedance 【 at 100MHz 】
900:90Ω
- (5) Impedance Tolerance
M : 20%
- (6) Number of Line
2P:2-Line
- (7) Taping Type

3. Shapes and Dimensions [Dimensions in mm]

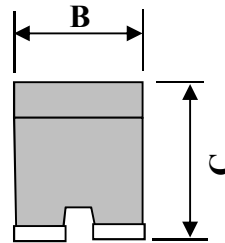
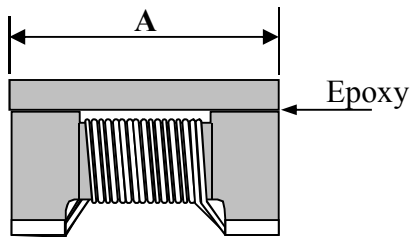

A : 3.2 ± 0.2

B : 1.6 ± 0.2

C : 1.8 ± 0.2

Terminations

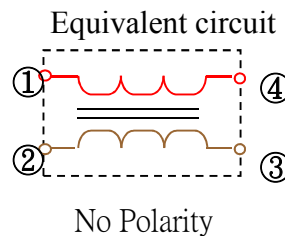
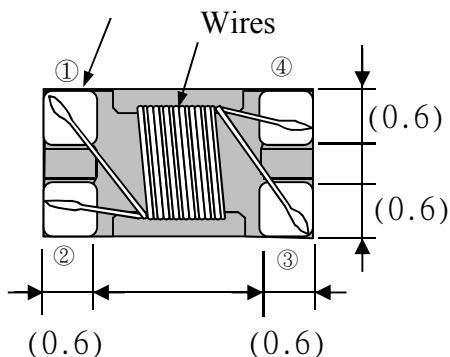

Drawn by	Checked by	Approved by
Cindy Mar. 20. 2017	Zheng Mar. 20. 2017	Sun Mar. 20. 2017

PRODUCT SPECIFICATION

SPEC. NO.

T-0602-015H



4. Electrical Characteristics

4-1 Electrical Spec.

Our Product Part Number	Common-Mode Impedance $Z(\Omega)$ at 100MHz	DC Resistance $R_{dc}(\Omega)$ Max.	Rated Current $I_{dc}(mA)$ Max.	Rated Voltage $V_{dc}(V)$	Withstanding Voltage $V_{dc}(V)$	Insulation Resistance $(M\Omega)$ Min.
CMF3216F-370M-2P-T	37 \pm 20%	0.12	1000	50	125	10
CMF3216F-500M-2P-T	50 \pm 20%	0.20	500	50	125	10
CMF3216F-670M-2P-T	67 \pm 20%	0.30	500	50	125	10
CMF3216F-900M-2P-T	90 \pm 20%	0.30	500	50	125	10
CMF3216F-121M-2P-T	120 \pm 20%	0.30	370	50	125	10
CMF3216F-161M-2P-T	160 \pm 20%	0.40	340	50	125	10
CMF3216F-261M-2P-T	260 \pm 20%	0.50	310	50	125	10
CMF3216F-601M-2P-T	600 \pm 20%	0.80	260	50	125	10
CMF3216F-102M-2P-T	1000 \pm 20%	1.00	230	50	125	10
CMF3216F-222M-2P-T	2200 \pm 20%	1.20	200	50	125	10

4-2 Characteristics(Reference)

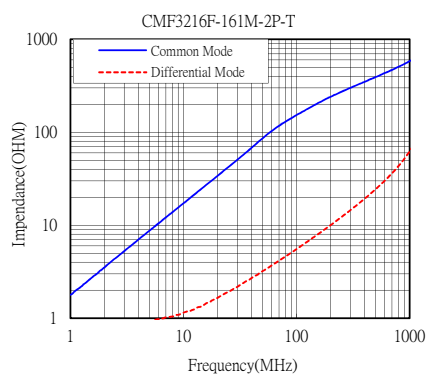
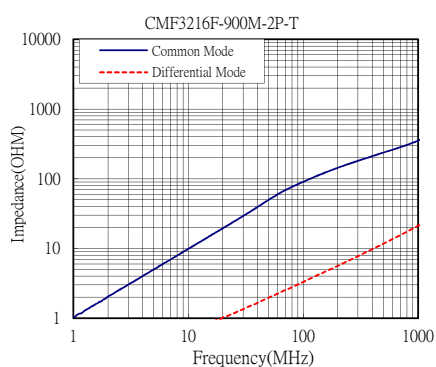
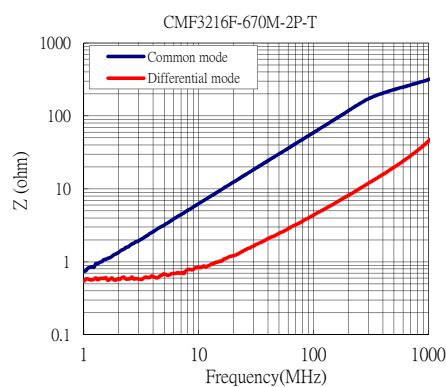
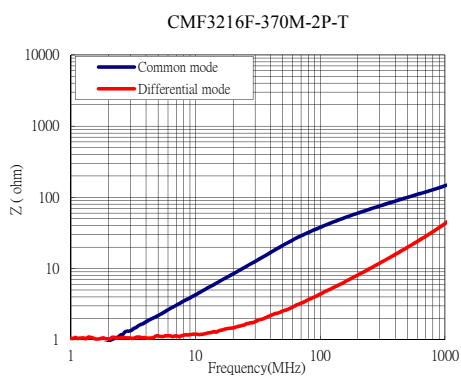

PRODUCT SPECIFICATION

SPEC. NO.

T-0602-015H



4-2 Characteristics(Reference)

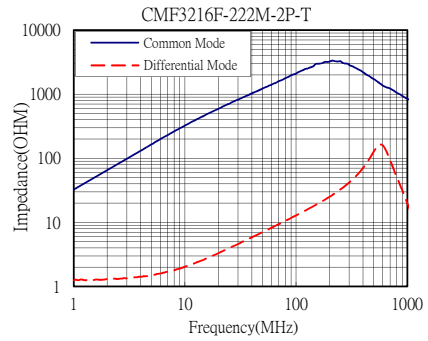
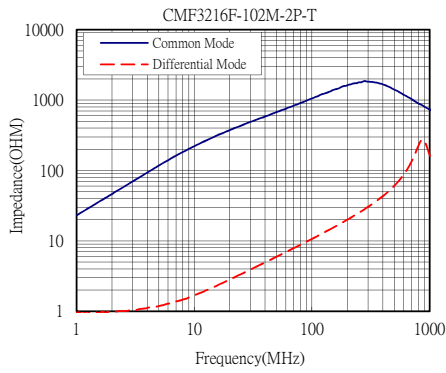
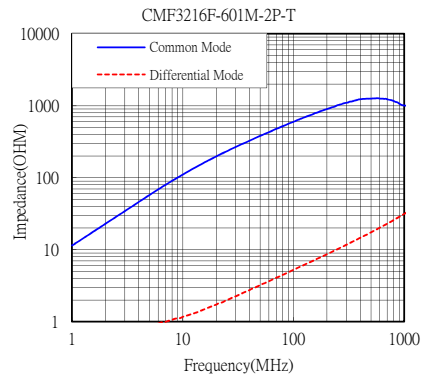
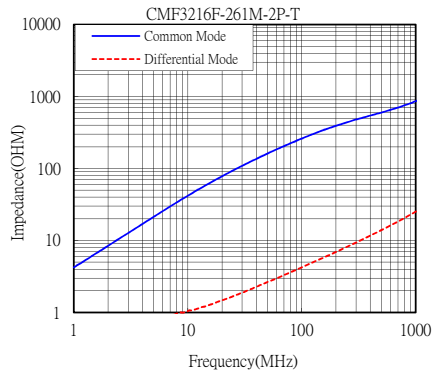

PRODUCT SPECIFICATION

SPEC. NO.

T-0602-015H



4-3 Test Equipment

4-3-1 Impedance

Measured by using Agilent E4991A RF Impedance Analyzer.

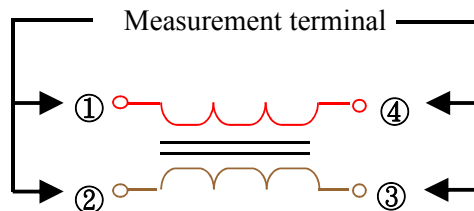

4-3-2 DC Resistance

Measured by using Chroma 16502 mill ohm meter.

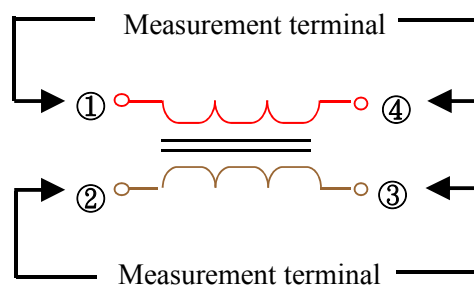

4-3-3 Insulation Resistance

Measured by using Chroma 19073

Measurement voltage : 50v.

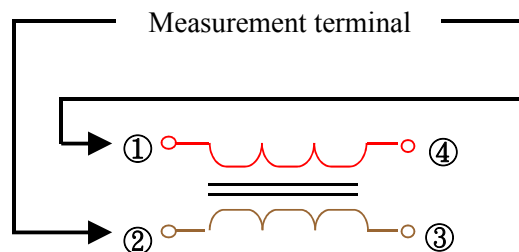

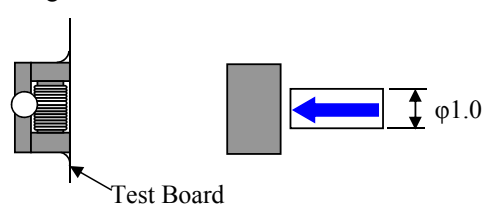
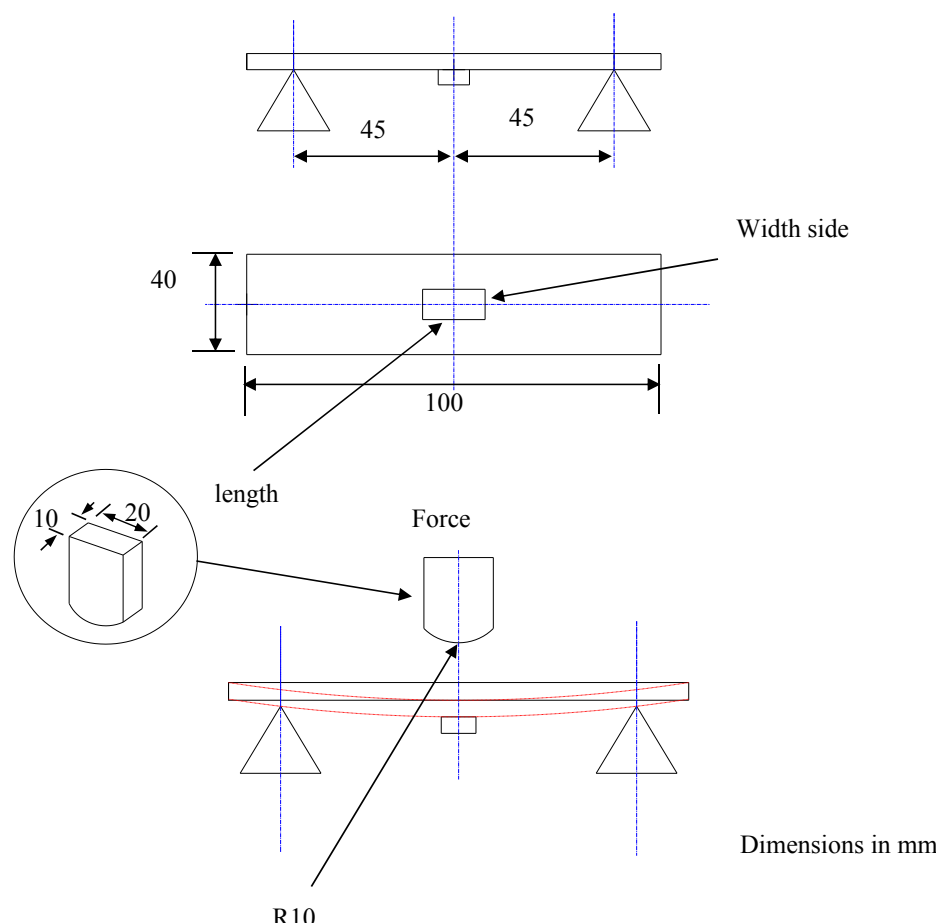

5. Reliability Test

Operating temperature : -25 to +85°C		Storage temp and humidity : 20~25°C ,60%RH max.
Item	Specifications	Test conditions
Solder ability	It can be connected on the Recommendation soldering condition.	Apply cream solder to the test circuit board . It is mounted on the recommendation soldering condition.
Terminal strength	The terminal electrode and the ferrite must not be damaged.	Solder a chip to test substrate , and then laterally apply a load 0.9Kg in the arrow direction. 
Strength on pc board bending	The terminal electrode and the ferrite must not be damaged.	Soldering a chip to a test substrate , bend the substrate by 2mm and then return.  <p>Test board : Glass base epoxy multiplayer board pc board pattern. PC board pattern : Recommended PC board pattern.</p>

PRODUCT SPECIFICATION

SPEC. NO.

T-0602-015H

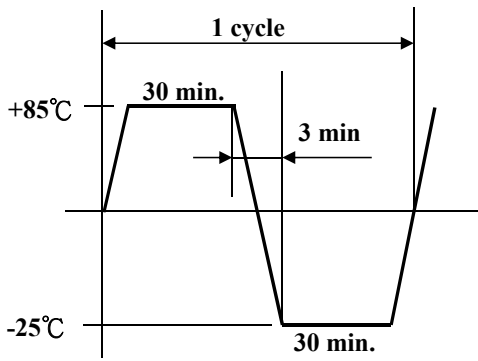

Item	Specifications	Test conditions
High temperature resistance	Appearance : Ferrite shall not be damaged. Impedance : Within $\pm 20\%$ of the initial value. insulation resistance: $>10(M\Omega)$ DC resistance : standard value inside.	Temperature : $+85\pm 2^{\circ}C$ Applied voltage : Rated voltage Applied current : Rated current Testing time : 50 ± 12 hours Measurement : After placing for 24 hours min.
Humidity resistance		Temperature : $+85\pm 2^{\circ}C$ Humidity : 90 to 95%RH Applied current : Rated current Applied voltage : Rated voltage Testing time : 500 ± 12 hours Measurement : After placing for 24 hours min.
Thermal cycle		Temperature : $-25^{\circ}C, +85^{\circ}C$ kept stabilized for 30 minutes each. Cycle : 5 cycle Measurement : After placing for 24 hours min. 
Low temperature resistance		Temperature : $-25\pm 2^{\circ}C$ Testing time : 48 ± 12 hours Measurement : After placing for 24 hours min.
Vibration	Appearance : Ferrite shall not be damaged.	Frequency : 10 to 50 Hz Amplitude : 1.52 mm Dimension and times : X ,Y and Z directions for 2 hours each.

PRODUCT SPECIFICATION

SPEC. NO.
T-0602-015H



6. Packaging

The packaging must be done not to receive any damage during transporting and storing

6-1 Tape dimensions

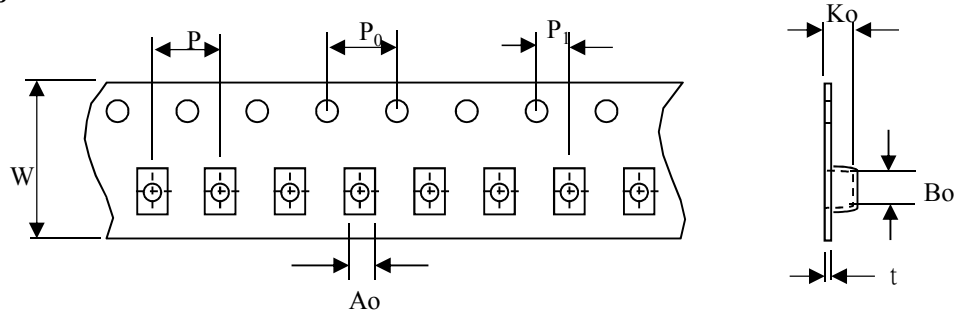

(Dimensions in mm; Tolerance : ± 0.1)

Symbol	W	P	P_0	P_1	A_0	B_0	K_0	t
Dimension	8	4	4	2	1.75	3.45	2	0.23

6-2 Reel dimensions

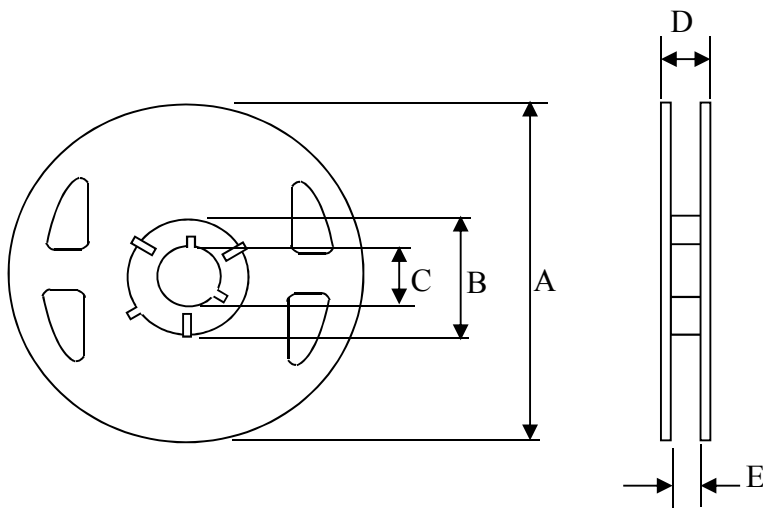

(Dimensions in mm)

Symbol	T
A	180
B	60
C	13
D	14.4
E	8.4

6-3 Tapping figure

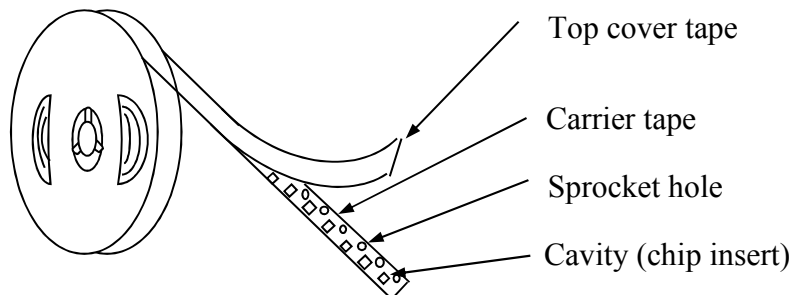

PRODUCT SPECIFICATION

SPEC. NO.

T-0602-015H



6-4 Packaging Form

There shall not continuation more than two vacancies of the product.

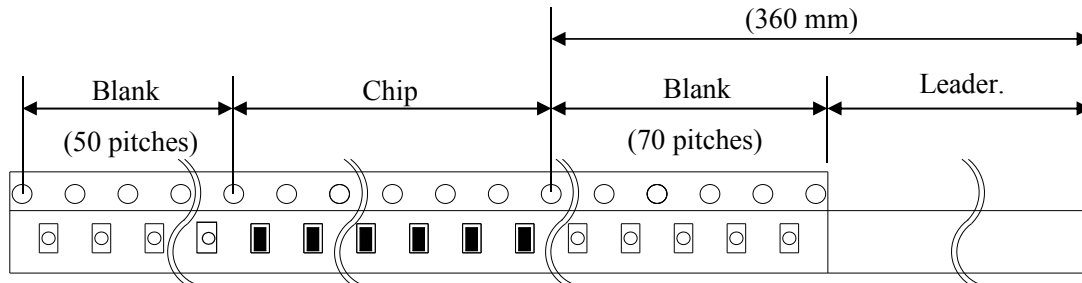

() : Reference

Material of carrier tape : Polystyrene

Material of cover tape : Polyester

6-5 Cover Tape Peel Strength

The force for tearing off cover tape is 0.05~0.69(N) in the arrow direction at the following conditions:

Temperature : 5 ~ 35°C

Humidity : 45 ~ 85%

Atmospheric pressure : 860 ~ 1060 hpa

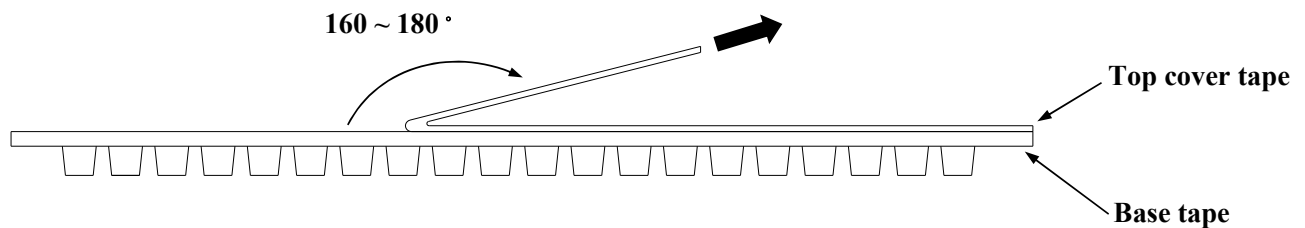

6-6 Packing Quantity

φ180 mm reel T type : 2000 pcs./reel

PRODUCT SPECIFICATION

SPEC. NO.

T-0602-015H



7. Recommended Soldering Conditions (Please use this product by reflow soldering)

7-1 Recommended Footprint

Termination Number : Please refer to the equivalent circuit in chapter 3.

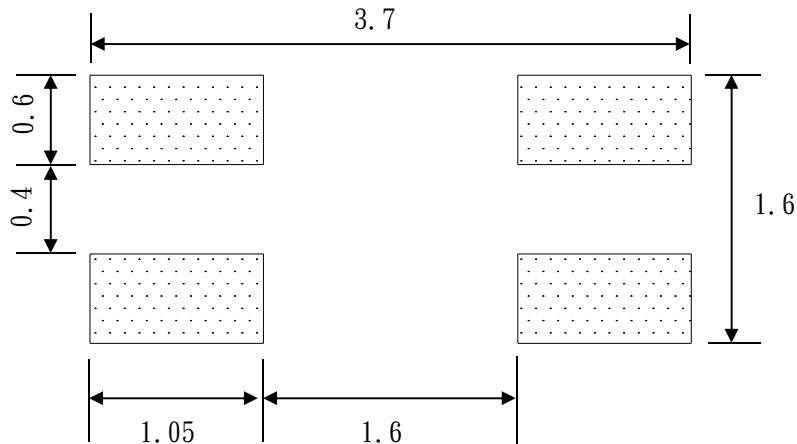

7-2 Recommended Reflow Pattern

Reflow : until two times

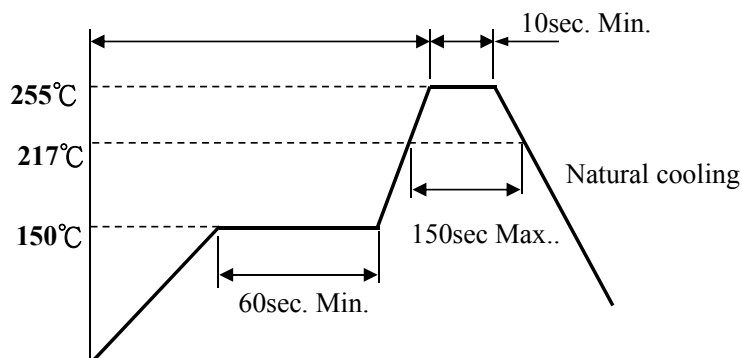

7-2 Iron Soldering

Use a solder iron of less than 30W when soldering ,do not allow the soldering iron tip directly touch the ferrite body outside of terminal electrode.

5 seconds max. at 260°C .

8. Attention in Case of Using

In case of using product ,please avoid following matters:

Splashing water or salt water

Dew condenses

Toxic gas (Hydrogen sulfide, Sulfurous acid ,Chlorine, Ammonia)

Vibrations or shocks which exceed the specified condition

Please be careful for the stress to this product by board flexure or something after the mounting.

9. Other

Recommended wire wound inductors should be used within 6 months from the time of delivery.