



SQH4012S SERIES ~ Low Profile SMD Power Inductors



PART NUMBERING SYSTEM

SQH	4012S	—	150M	—	LF
TYPE	DIMENSIONS		INDUCTANCE		LEAD FREE

SHAPES AND DIMENSIONS

UNIT : mm

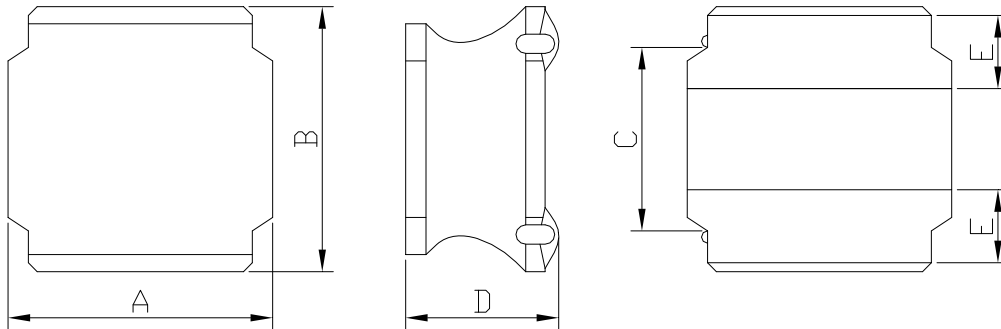

A=4.2 Max. B=4.2 Max. C=2.5 Ref. D=1.2 Max. E=1.1±0.2

RECOMMENDED PATTERNS

UNIT : mm



G= 1.40 H= 3.60 I = 1.20

FEATURES

- * Low profile and small inductors (4.2mm Max. square and 1.2mm Max. height)
- * Magnetically shielded construction and high current
- * Ideal for DC-DC converter choke coil for portable equipments (DVDs , DSC , Cellular , PDAs)
- * RoHS compliant option with lead free



SQH4012S SERIES ~ Low Profile SMD Power Inductors



SPECIFICATION TABLE

PART NUMBER	INDUCTANCE (μ H)	DCR (Ω) (Max.)	Isat (A) (Max.)	Irms (A) (Max.)	TEST FREQ. (f)
SQH4012S-1R0N-LF	1.0 \pm 30%	0.072	2.50	1.50	100KHz
SQH4012S-2R2M-LF	2.2 \pm 20%	0.108	1.65	1.20	100KHz
SQH4012S-3R3M-LF	3.3 \pm 20%	0.156	1.20	0.98	100KHz
SQH4012S-4R7M-LF	4.7 \pm 20%	0.168	1.05	0.96	100KHz
SQH4012S-6R8M-LF	6.8 \pm 20%	0.216	0.90	0.84	100KHz
SQH4012S-100M-LF	10 \pm 20%	0.288	0.74	0.77	100KHz
SQH4012S-150M-LF	15 \pm 20%	0.480	0.56	0.60	100KHz
SQH4012S-220M-LF	22 \pm 20%	0.576	0.51	0.54	100KHz
SQH4012S-330M-LF	33 \pm 20%	0.972	0.40	0.42	100KHz
SQH4012S-470M-LF	47 \pm 20%	1.200	0.35	0.37	100KHz

- Isat : DC current at which the inductance drops 30%(typ) from its value without current.
- Irms : The temperature rise current value is the DC current value having temperature increase up 40°C temperature rise from 25°C ambient.
- Operating temperature range -40°C to +105°C , Electrical specifications at 25°C .