



Is Now Part of



ON Semiconductor®

To learn more about ON Semiconductor, please visit our website at
www.onsemi.com

Please note: As part of the Fairchild Semiconductor integration, some of the Fairchild orderable part numbers will need to change in order to meet ON Semiconductor's system requirements. Since the ON Semiconductor product management systems do not have the ability to manage part nomenclature that utilizes an underscore (_), the underscore (_) in the Fairchild part numbers will be changed to a dash (-). This document may contain device numbers with an underscore (_). Please check the ON Semiconductor website to verify the updated device numbers. The most current and up-to-date ordering information can be found at www.onsemi.com. Please email any questions regarding the system integration to Fairchild_questions@onsemi.com.

ON Semiconductor and the ON Semiconductor logo are trademarks of Semiconductor Components Industries, LLC dba ON Semiconductor or its subsidiaries in the United States and/or other countries. ON Semiconductor owns the rights to a number of patents, trademarks, copyrights, trade secrets, and other intellectual property. A listing of ON Semiconductor's product/patent coverage may be accessed at www.onsemi.com/site/pdf/Patent-Marking.pdf. ON Semiconductor reserves the right to make changes without further notice to any products herein. ON Semiconductor makes no warranty, representation or guarantee regarding the suitability of its products for any particular purpose, nor does ON Semiconductor assume any liability arising out of the application or use of any product or circuit, and specifically disclaims any and all liability, including without limitation special, consequential or incidental damages. Buyer is responsible for its products and applications using ON Semiconductor products, including compliance with all laws, regulations and safety requirements or standards, regardless of any support or applications information provided by ON Semiconductor. "Typical" parameters which may be provided in ON Semiconductor data sheets and/or specifications can and do vary in different applications and actual performance may vary over time. All operating parameters, including "Typicals" must be validated for each customer application by customer's technical experts. ON Semiconductor does not convey any license under its patent rights nor the rights of others. ON Semiconductor products are not designed, intended, or authorized for use as a critical component in life support systems or any FDA Class 3 medical devices or medical devices with a same or similar classification in a foreign jurisdiction or any devices intended for implantation in the human body. Should Buyer purchase or use ON Semiconductor products for any such unintended or unauthorized application, Buyer shall indemnify and hold ON Semiconductor and its officers, employees, subsidiaries, affiliates, and distributors harmless against all claims, costs, damages, and expenses, and reasonable attorney fees arising out of, directly or indirectly, any claim of personal injury or death associated with such unintended or unauthorized use, even if such claim alleges that ON Semiconductor was negligent regarding the design or manufacture of the part. ON Semiconductor is an Equal Opportunity/Affirmative Action Employer. This literature is subject to all applicable copyright laws and is not for resale in any manner.

74VCX164245

Low Voltage 16-Bit Dual Supply Translating Transceiver with 3-STATE Outputs

General Description

The VCX164245 is a dual supply, 16-bit translating transceiver that is designed for two way asynchronous communication between busses at different supply voltages by providing true signal translation. The supply rails consist of V_{CCB} , which is the higher potential rail operating at 2.3V to 3.6V and V_{CCA} , which is the lower potential rail operating at 1.65V to 2.7V. (V_{CCA} must be less than or equal to V_{CCB} for proper device operation.) This dual supply design allows for translation from 1.8V to 2.5V busses to busses at a higher potential, up to 3.3V.

The Transmit/Receive (T/\bar{R}) input determines the direction of data flow. Transmit (active-HIGH) enables data from A Ports to B Ports. Receive (active-LOW) enables data from B Ports to A Ports. The Output Enable (\overline{OE}) input, when HIGH, disables both A and B Ports by placing them in a High-Z condition. The A Port interfaces with the lower voltage bus (1.8V – 2.5V). The B Port interfaces with the higher voltage bus (2.7V – 3.3V). Also the VCX164245 is designed so that the control pins (T/\bar{R}_n , \overline{OE}_n) are supplied by V_{CCB} .

The 74VCX164245 is suitable for mixed voltage applications such as notebook computers using a 1.8V CPU and 3.3V peripheral components. It is fabricated with an Advanced CMOS technology to achieve high speed operation while maintaining low CMOS power dissipation.

Features

- Bidirectional interface between busses ranging from 1.65V to 3.6V
- Supports Live Insertion and Withdrawal (Note 1)
- Static Drive (I_{OH}/I_{OL})
 - ±24 mA @ 3.0V V_{CC}
 - ±18 mA @ 2.3V V_{CC}
 - ±6 mA @ 1.65V V_{CC}
- Uses proprietary noise/EMI reduction circuitry
- Functionally compatible with 74 series 16245
- Latchup performance exceeds 300 mA
- ESD performance:
 - Human Body Model >2000V
 - Machine model >200V
- Also packaged in plastic Fine-Pitch Ball Grid Array (FBGA)

Note 1: To ensure the high impedance state during power up or power down, OE_n should be tied to V_{CCB} through a pull up resistor. The minimum value of the resistor is determined by the current sourcing capability of the driver.

Ordering Code:

Order Number	Package Number	Package Description
74VCX164245G (Note 2)(Note 3)	BGA54A	54-Ball Fine-Pitch Ball Grid Array (FBGA), JEDEC MO-205, 5.5mm Wide
74VCX164245MTD (Note 3)	MTD48	48-Lead Thin Shrink Small Outline Package (TSSOP), JEDEC MO-153, 6.1mm Wide

Note 2: Ordering Code "G" indicates Trays.

Note 3: Device also available in Tape and Reel. Specify by appending suffix letter "X" to the ordering code.

Logic Diagram

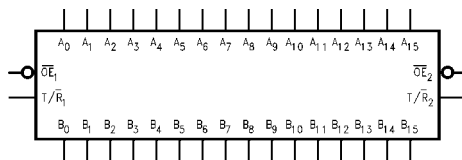

Connection Diagrams

Pin Assignment for TSSOP

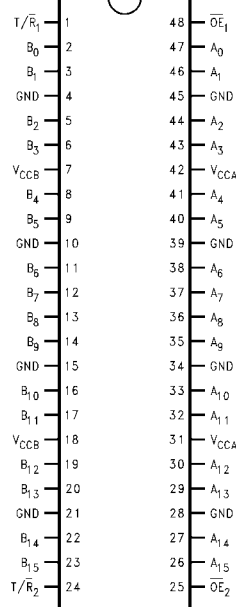

Pin Assignment for FBGA

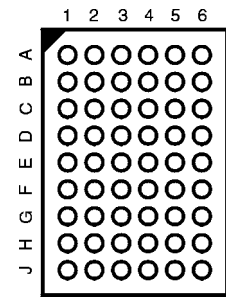

(Top Through View)

Pin Descriptions

Pin Names	Description
\overline{OE}_n	Output Enable Input (Active LOW)
$\overline{T/R}_n$	Transmit/Receive Input
A_0 - A_{15}	Side A Inputs or 3-STATE Outputs
B_0 - B_{15}	Side B Inputs or 3-STATE Outputs
NC	No Connect

FBGA Pin Assignments

	1	2	3	4	5	6
A	B_0	NC	$\overline{T/R}_1$	\overline{OE}_1	NC	A_0
B	B_2	B_1	NC	NC	A_1	A_2
C	B_4	B_3	V_{CCB}	V_{CCA}	A_3	A_4
D	B_6	B_5	GND	GND	A_5	A_6
E	B_8	B_7	GND	GND	A_7	A_8
F	B_{10}	B_9	GND	GND	A_9	A_{10}
G	B_{12}	B_{11}	V_{CCB}	V_{CCA}	A_{11}	A_{12}
H	B_{14}	B_{13}	NC	NC	A_{13}	A_{14}
J	B_{15}	NC	$\overline{T/R}_2$	\overline{OE}_2	NC	A_{15}

Truth Tables

Inputs		Outputs
\overline{OE}_1	$\overline{T/R}_1$	
L	L	Bus B_0 - B_7 Data to Bus A_0 - A_7
L	H	Bus A_0 - A_7 Data to Bus B_0 - B_7
H	X	HIGH Z State on A_0 - A_7 , B_0 - B_7

Inputs		Outputs
\overline{OE}_2	$\overline{T/R}_2$	
L	L	Bus B_8 - B_{15} Data to Bus A_8 - A_{15}
L	H	Bus A_8 - A_{15} Data to Bus B_8 - B_{15}
H	X	HIGH-Z State on A_8 - A_{15} , B_8 - B_{15}

H = HIGH Voltage Level
 L = LOW Voltage Level
 X = Immaterial (HIGH or LOW, inputs may not float)
 Z = High Impedance

Translator Power Up Sequence Recommendations

To guard against power up problems, some simple guidelines need to be adhered to. The VCX164245 is designed so that the control pins ($\overline{T/R}_n$, \overline{OE}_n) are supplied by V_{CCB} . Therefore the first recommendation is to begin by powering up the control side of the device, V_{CCB} . The \overline{OE}_n control pins should be ramped with or ahead of V_{CCB} , this will guard against bus contentions and oscillations as all A Port and B Port outputs will be disabled. To ensure the high impedance state during power up or power down, \overline{OE}_n should be tied to V_{CCB} through a pull up resistor. The minimum value of the resistor is determined by the current

sourcing capability of the driver. Second, the $\overline{T/R}_n$ control pins should be placed at logic low (0V) level, this will ensure that the B-side bus pins are configured as inputs to help guard against bus contention and oscillations. B-side Data Inputs should be driven to a valid logic level (0V or V_{CCB}), this will prevent excessive current draw and oscillations. V_{CCA} can then be powered up after V_{CCB} , but should never exceed the V_{CCB} voltage level. Upon completion of these steps the device can then be configured for the users desired operation. Following these steps will help to prevent possible damage to the translator device as well as other system components.

Absolute Maximum Ratings (Note 4)

Supply Voltage	
V_{CCA}	-0.5V to V_{CCB}
V_{CCB}	-0.5V to 4.6V
DC Input Voltage (V_I)	-0.5V to +4.6V
DC Output Voltage ($V_{I/O}$)	
Outputs 3-STATE	-0.5V to +4.6V
Outputs Active (Note 5)	
A_n	-0.5V to $V_{CCA} + 0.5V$
B_n	-0.5V to $V_{CCB} + 0.5V$
DC Input Diode Current (I_{IK})	
$V_I < 0V$	-50 mA
DC Output Diode Current (I_{OK})	
$V_O < 0V$	-50 mA
$V_O > V_{CC}$	+50 mA
DC Output Source/Sink Current (I_{OH}/I_{OL})	± 50 mA
DC V_{CC} or Ground Current	± 100 mA
Supply Pin (I_{CC} or Ground)	
Storage Temperature (T_{STG})	-65°C to +150°C

Recommended Operating Conditions (Note 6)

Power Supply (Note 7)	
V_{CCA}	1.65V to 2.7V
V_{CCB}	2.3V to 3.6V
Input Voltage (V_I) @ \overline{OE} , T/\overline{R}	0V to V_{CCB}
Input/Output Voltage ($V_{I/O}$)	
A_n	0V to V_{CCA}
B_n	0V to V_{CCB}
Output Current in I_{OH}/I_{OL}	
$V_{CCA} = 2.3V$ to 2.7V	± 18 mA
$V_{CCA} = 1.65V$ to 1.95V	± 6 mA
$V_{CCB} = 3.0V$ to 3.6V	± 24 mA
$V_{CCB} = 2.3V$ to 2.7V	± 18 mA
Free Air Operating Temperature (T_A)	-40°C to +85°C
Minimum Input Edge Rate ($\Delta V/\Delta V$)	
$V_{IN} = 0.8V$ to 2.0V, $V_{CC} = 3.0V$	10 ns/V

Note 4: The "Absolute Maximum Ratings" are those values beyond which the safety of the device cannot be guaranteed. The device should not be operated at these limits. The parametric values defined in the Electrical Characteristics tables are not guaranteed at the absolute maximum ratings. The "Recommended Operating Conditions" table will define the conditions for actual device operation.

Note 5: I_O Absolute Maximum Rating must be observed.

Note 6: Unused inputs or I/O pins must be held HIGH or LOW. They may not float.

Note 7: Operation requires: $V_{CCA} \leq V_{CCB}$

DC Electrical Characteristics (1.65V < $V_{CCA} \leq 1.95V$, 2.3V < $V_{CCB} \leq 2.7V$)

Symbol	Parameter	Conditions	V_{CCA} (V)	V_{CCB} (V)	Min	Max	Units
V_{IHA}	HIGH Level Input Voltage	A_n	1.65-1.95	2.3-2.7	$0.65 \times V_{CC}$		V
V_{IHB}		B_n , T/\overline{R} , \overline{OE}	1.65-1.95	2.3-2.7	1.6		V
V_{ILA}	LOW Level Input Voltage	A_n	1.6-1.95	2.3-2.7		$0.35 \times V_{CC}$	V
V_{ILB}		B_n , T/\overline{R} , \overline{OE}	1.65-1.95	2.3-2.7		0.7	V
V_{OHA}	HIGH Level Output Voltage	$I_{OH} = -100 \mu A$ $I_{OH} = -6$ mA	1.65-1.95 1.65	2.3-2.7 2.3-2.7	$V_{CCA}-0.2$ 1.25		V
V_{OHB}	HIGH Level Output Voltage	$I_{OH} = -100 \mu A$ $I_{OH} = -18$ mA	1.65-1.95 1.65-1.95	2.3-2.7 2.3	$V_{CCB}-0.2$ 1.7		V
V_{OLA}	LOW Level Output Voltage	$I_{OL} = 100 \mu A$ $I_{OL} = 6$ mA	1.65-1.95 1.65	2.3-2.7 2.3-2.7		0.2 0.3	V
V_{OLB}	LOW Level Output Voltage	$I_{OL} = 100 \mu A$ $I_{OL} = 18$ mA	1.65-1.95 1.65-1.95	2.3-2.7 2.3		0.2 0.6	V
I_I	Input Leakage Current @ \overline{OE} , T/\overline{R}	$0V \leq V_I \leq 3.6V$	1.65-1.95	2.3-2.7		± 5.0	μA
I_{OZ}	3-STATE Output Leakage	$0V \leq V_O \leq 3.6V$ $\overline{OE} = V_{CCB}$ $V_I = V_{IH}$ or V_{IL}	1.65-1.95	2.3-2.7		± 10	μA
I_{OFF}	Power OFF Leakage Current	$0 \leq (V_I, V_O) \leq 3.6V$	0	0		10	μA
I_{CCA}/I_{CCB}	Quiescent Supply Current, per supply, V_{CCA} / V_{CCB}	$A_n = V_{CCA}$ or GND B_n , \overline{OE} , & $T/\overline{R} = V_{CCB}$ or GND $V_{CCA} \leq A_n \leq 3.6V$ $V_{CCB} \leq B_n$, \overline{OE} , $T/\overline{R} \leq 3.6V$	1.65-1.95	2.3-2.7		20	μA
			1.65-1.95	2.3-2.7		± 20	μA
ΔI_{CC}	Increase in I_{CC} per Input, B_n , T/\overline{R} , \overline{OE}	$V_I = V_{CCB} - 0.6V$	1.65-1.95	2.3-2.7		750	μA
	Increase in I_{CC} per Input, A_n	$V_I = V_{CCA} - 0.6V$	1.65-1.95	2.3-2.7		750	μA

DC Electrical Characteristics (1.65V < V _{CCA} ≤ 1.95V, 3.0V < V _{CCB} ≤ 3.6V)								
Symbol	Parameter		Conditions	V _{CCA} (V)	V _{CCB} (V)	Min	Max	Units
V _{IHA}	HIGH Level	A _n		1.65–1.95	3.0–3.6	0.65 x V _{CC}		V
V _{IHB}	Input Voltage	B _n , T/R, \overline{OE}		1.65–1.95	3.0–3.6	2.0		V
V _{ILA}	LOW Level	A _n		1.65–1.95	3.0–3.6		0.35 x V _{CC}	V
V _{ILB}	Input Voltage	B _n , T/R, \overline{OE}		1.65–1.95	3.0–3.6		0.8	V
V _{OHA}	HIGH Level Output Voltage		I _{OH} = –100 μA I _{OH} = –6 mA	1.65–1.95 1.65	3.0–3.6 3.0–3.6	V _{CCA} –0.2 1.25		V
V _{OHB}	HIGH Level Output Voltage		I _{OH} = –100 μA I _{OH} = –24 mA	1.65–1.95 1.65–1.95	3.0–3.6 3.0	V _{CCA} –0.2 2.2		V
V _{OLA}	LOW Level Output Voltage		I _{OL} = 100 μA I _{OL} = 6 mA	1.65–1.95 1.65	3.0–3.6 3.0–3.6		0.2 0.3	V
V _{OLB}	LOW Level Output Voltage		I _{OL} = 100 μA I _{OL} = 24 mA	1.65–1.95 1.65–1.95	3.0–3.6 3.0		0.2 0.55	V
I _I	Input Leakage Current @ \overline{OE} , T/R		0V ≤ V _I ≤ 3.6V	1.65–1.95	3.0–3.6		±5.0	μA
I _{OZ}	3-STATE Output Leakage		0V ≤ V _O ≤ 3.6V OE* = V _{CCB} V _I = V _{IH} or V _{IL}	1.65–1.95	3.0–3.6		±10	μA
I _{OFF}	Power Off Leakage Current		0 ≤ (V _I , V _O) ≤ 3.6V	0	0		10	μA
I _{CCA} /I _{CCB}	Quiescent Supply Current, per supply, V _{CCA} /V _{CCB}		A _n = V _{CCA} or GND B _n , \overline{OE} , & T/R = V _{CCB} or GND	1.65–1.95	3.0–3.6		20	μA
			V _{CCA} ≤ A _n ≤ 3.6V V _{CCB} ≤ B _n , \overline{OE} , T/R ≤ 3.6V	1.65–1.95	3.0–3.6		±20	μA
ΔI _{CC}	Increase in I _{CC} per Input, B _n , T/R, \overline{OE}		V _I = V _{CCB} – 0.6V	1.65–1.95	3.0–3.6		750	μA
	Increase in I _{CC} per Input, A _n		V _I = V _{CCA} – 0.6V	1.65–1.95	3.0–3.6		750	μA
DC Electrical Characteristics (2.3V < V _{CCA} ≤ 2.7V, 3.0V ≤ V _{CCB} ≤ 3.6V)								
Symbol	Parameter		Conditions	V _{CCA} (V)	V _{CCB} (V)	Min	Max	Units
V _{IHA}	HIGH Level Input Voltage	A _n		2.3–2.7	3.0–3.6	1.6		V
V _{IHB}	Input Voltage	B _n , T/R, \overline{OE}		2.3–2.7	3.0–3.6	2.0		V
V _{ILA}	LOW Level Input Voltage	A _n		2.3–2.7	3.0–3.6		0.7	V
V _{ILB}	Input Voltage	B _n , T/R, \overline{OE}		2.3–2.7	3.0–3.6		0.8	V
V _{OHA}	HIGH Level Output Voltage		I _{OH} = –100 μA I _{OH} = –18 mA	2.3–2.7 2.3	3.0–3.6 3.0–3.6	V _{CCA} –0.2 1.7		V
V _{OHB}	HIGH Level Output Voltage		I _{OH} = –100 μA I _{OH} = –24 mA	2.3–2.7 2.3–2.7	3.0–3.6 3.0	V _{CCB} –0.2 2.2		V
V _{OLA}	LOW Level Output Voltage		I _{OL} = 100 μA I _{OL} = 18 mA	2.3–2.7 2.3	3.0–3.6 3.0–3.6		0.2 0.6	V
V _{OLB}	LOW Level Output Voltage		I _{OL} = 100 μA I _{OL} = 24 mA	2.3–2.7 2.3–2.7	3.0–3.6 3.0		0.2 0.55	V
I _I	Input Leakage Current @ \overline{OE} , T/R		0V ≤ V _I ≤ 3.6V	2.3–2.7	3.0–3.6		±5.0	μA
I _{OZ}	3-STATE Output Leakage @ A _n		0V ≤ V _O ≤ 3.6V \overline{OE} = V _{CCA} V _I = V _{IH} or V _{IL}	2.3–2.7	3.0–3.6		±10	μA
I _{OFF}	Power OFF Leakage Current		0 ≤ (V _I , V _O) ≤ 3.6V	0	0		10	μA
I _{CCA} /I _{CCB}	Quiescent Supply Current, per supply, V _{CCA} /V _{CCB}		A _n = V _{CCA} or GND B _n , \overline{OE} , & T/R = V _{CCB} or GND	2.3–2.7	3.0–3.6		20	μA
			V _{CCA} ≤ A _n ≤ 3.6V V _{CCB} ≤ B _n , \overline{OE} , T/R ≤ 3.6V	2.3–2.7	3.0–3.6		±20	μA
ΔI _{CC}	Increase in I _{CC} per Input, B _n , T/R, \overline{OE}		V _I = V _{CCB} – 0.6V	2.3–2.7	3.0–3.6		750	μA
	Increase in I _{CC} per Input, A _n		V _I = V _{CCA} – 0.6V	2.3–2.7	3.0–3.6		750	μA

AC Electrical Characteristics

Symbol	Parameter	$C_L = 30 \text{ pF}, R_L = 500\Omega, T_A = -40^\circ\text{C to } +85^\circ\text{C}$						Units
		$V_{CCA} = 1.65\text{V to } 1.95\text{V}$		$V_{CCA} = 1.65\text{V to } 1.95\text{V}$		$V_{CCA} = 2.3\text{V to } 2.7\text{V}$		
		$V_{CCB} = 2.3\text{V to } 2.7\text{V}$		$V_{CCB} = 3.0\text{V to } 3.6\text{V}$		$V_{CCB} = 3.0\text{V to } 3.6\text{V}$		
		Min	Max	Min	Max	Min	Max	
t_{PHL}, t_{PLH}	Propagation Delay, A to B	0.8	5.5	0.6	5.1	0.6	4.0	ns
t_{PHL}, t_{PLH}	Propagation Delay, B to A	1.5	5.8	1.5	6.2	0.8	4.4	ns
t_{PZL}, t_{PZH}	Output Enable Time, OE to B	0.8	5.3	0.6	5.1	0.6	4.0	ns
t_{PZL}, t_{PZH}	Output Enable Time, OE to A	1.5	8.3	1.5	8.2	0.8	4.6	ns
t_{PLZ}, t_{PHZ}	Output Disable Time, OE to B	0.8	5.2	0.8	5.6	0.8	4.8	ns
t_{PLZ}, t_{PHZ}	Output Disable Time, OE to A	0.8	4.6	0.8	4.5	0.8	4.4	ns
t_{osHL} t_{osLH}	Output to Output Skew (Note 8)		0.5		0.5		0.75	ns

Note 8: Skew is defined as the absolute value of the difference between the actual propagation delay for any two separate outputs of the same device. The specification applies to any outputs switching in the same direction, either HIGH-to-LOW (t_{osHL}) or LOW-to-HIGH (t_{osLH}).

Dynamic Switching Characteristics

Symbol	Parameter	Conditions	V_{CCA} (V)	V_{CCB} (V)	$T_A = 25^\circ\text{C}$	Units
					Typical	
V_{OLP}	Quiet Output Dynamic Peak V_{OL} , B to A	$C_L = 30 \text{ pF}, V_{IH} = V_{CC}, V_{IL} = 0\text{V}$	1.8	2.5	0.25	V
			1.8	3.3	0.25	
			2.5	3.3	0.6	
V_{OLV}	Quiet Output Dynamic Peak V_{OL} , A to B	$C_L = 30 \text{ pF}, V_{IH} = V_{CC}, V_{IL} = 0\text{V}$	1.8	2.5	0.6	V
			1.8	3.3	0.8	
			2.5	3.3	0.8	
V_{OLV}	Quiet Output Dynamic Valley V_{OL} , B to A	$C_L = 30 \text{ pF}, V_{IH} = V_{CC}, V_{IL} = 0\text{V}$	1.8	2.5	-0.25	V
			1.8	3.3	-0.25	
			2.5	3.3	-0.6	
V_{OLV}	Quiet Output Dynamic Valley V_{OL} , A to B	$C_L = 30 \text{ pF}, V_{IH} = V_{CC}, V_{IL} = 0\text{V}$	1.8	2.5	-0.6	V
			1.8	3.3	-0.8	
			2.5	3.3	-0.8	
V_{OHV}	Quiet Output Dynamic Valley V_{OH} , A to B	$C_L = 30 \text{ pF}, V_{IH} = V_{CC}, V_{IL} = 0\text{V}$	1.8	2.5	1.7	V
			1.8	3.3	2.0	
			2.5	3.3	2.0	
V_{OHV}	Quiet Output Dynamic Valley V_{OH} , B to A	$C_L = 30 \text{ pF}, V_{IH} = V_{CC}, V_{IL} = 0\text{V}$	1.8	2.5	1.3	V
			1.8	3.3	1.3	
			2.5	3.3	1.7	

Capacitance

Symbol	Parameter	Conditions	$T_A = +25^\circ\text{C}$	Units
			Typical	
C_{IN}	Input Capacitance	$V_{CCA} = 2.5\text{V}, V_{CCB} = 3.3\text{V}, V_I = 0\text{V}$ or $V_{CCA/B}$	5	pF
C_{IO}	Input/Output Capacitance	$V_{CCA} = 2.5\text{V}, V_{CCB} = 3.3\text{V}, V_I = 0\text{V}$ or $V_{CCA/B}$	6	pF
C_{PD}	Power Dissipation Capacitance	$V_{CCA} = 2.5\text{V}, V_{CCB} = 3.3\text{V}, V_I = 0\text{V}$ or $V_{CCA/B}$ $f = 10 \text{ MHz}$	20	pF

AC Loading and Waveforms

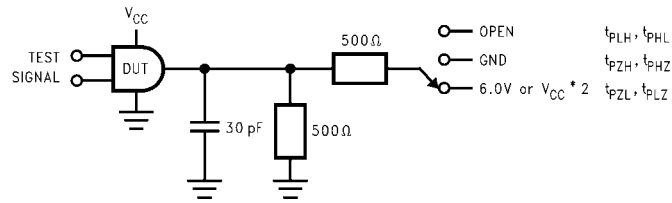

FIGURE 1. AC Test Circuit

TEST	SWITCH
t_{PLH}, t_{PHL}	OPEN
t_{PZL}, t_{PLZ}	6V at $V_{CC} = 3.3 \pm 0.3V$; $V_{CC} \times 2$ at $V_{CC} = 2.5 \pm 0.2V; 1.8V \pm 0.15V$
t_{PZH}, t_{PHZ}	GND

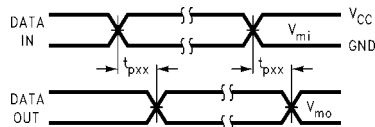

FIGURE 2. Waveform for Inverting and Non-inverting Functions
 $t_R = t_F \leq 2.0 \text{ ns}, 10\% \text{ to } 90\%$

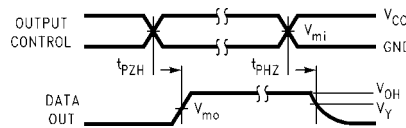

FIGURE 3. 3-STATE Output High Enable and Disable Times for Low Voltage Logic
 $t_R = t_F \leq 2.0 \text{ ns}, 10\% \text{ to } 90\%$

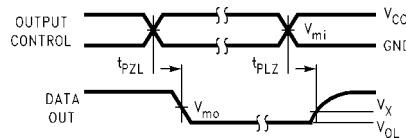
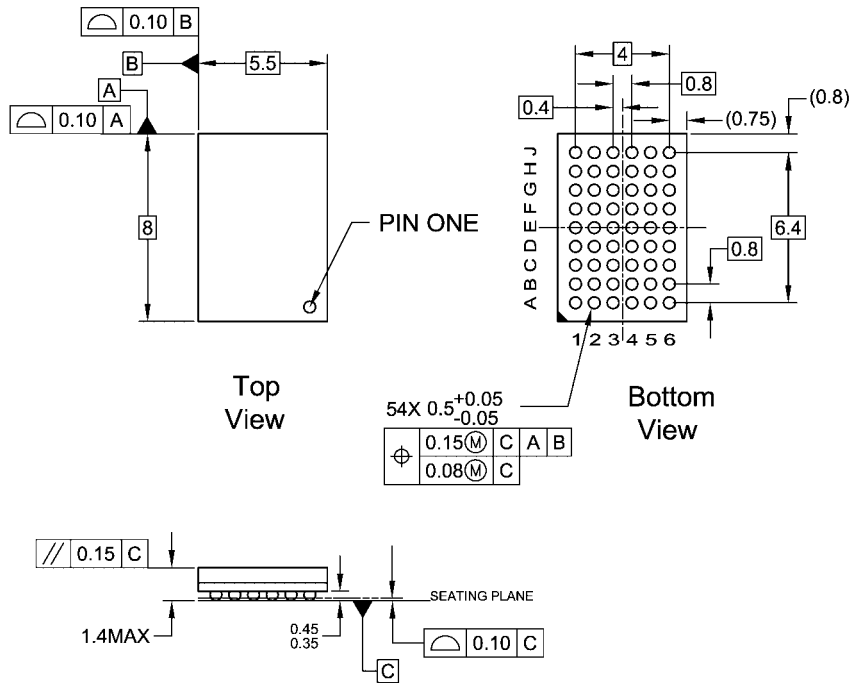

FIGURE 4. 3-STATE Output Low Enable and Disable Times for Low Voltage Logic
 $t_R = t_F \leq 2.0 \text{ ns}, 10\% \text{ to } 90\%$

Symbol	V_{CC}		
	$3.3V \pm 0.3V$	$2.5V \pm 0.2V$	$1.8V \pm 0.15V$
V_{mi}	1.5V	$V_{CC}/2$	$V_{CC}/2$
V_{mo}	1.5V	$V_{CC}/2$	$V_{CC}/2$
V_X	$V_{OL} + 0.3V$	$V_{OL} + 0.15V$	$V_{OL} + 0.15V$
V_Y	$V_{OH} - 0.3V$	$V_{OH} - 0.15V$	$V_{OH} - 0.15V$

Physical Dimensions inches (millimeters) unless otherwise noted



NOTES:

- A. THIS PACKAGE CONFORMS TO JEDEC M0-205
- B. ALL DIMENSIONS IN MILLIMETERS
- C. LAND PATTERN RECOMMENDATION: NSMD (Non Solder Mask Defined)
.35MM DIA PADS WITH A SOLDERMASK OPENING OF .45MM CONCENTRIC TO PADS
- D. DRAWING CONFORMS TO ASME Y14.5M-1994

BGA54ArevD

**54-Ball Fine-Pitch Ball Grid Array (FBGA), JEDEC M0-205, 5.5mm Wide
Package Number BGA54A**

Physical Dimensions inches (millimeters) unless otherwise noted (Continued)



MTD48REV C

**48-Lead Thin Shrink Small Outline Package (TSSOP), JEDEC MO-153, 6.1mm Wide
Package Number MTD48**

Fairchild does not assume any responsibility for use of any circuitry described, no circuit patent licenses are implied and Fairchild reserves the right at any time without notice to change said circuitry and specifications.

LIFE SUPPORT POLICY

FAIRCHILD'S PRODUCTS ARE NOT AUTHORIZED FOR USE AS CRITICAL COMPONENTS IN LIFE SUPPORT DEVICES OR SYSTEMS WITHOUT THE EXPRESS WRITTEN APPROVAL OF THE PRESIDENT OF FAIRCHILD SEMICONDUCTOR CORPORATION. As used herein:

1. Life support devices or systems are devices or systems which, (a) are intended for surgical implant into the body, or (b) support or sustain life, and (c) whose failure to perform when properly used in accordance with instructions for use provided in the labeling, can be reasonably expected to result in a significant injury to the user.
2. A critical component in any component of a life support device or system whose failure to perform can be reasonably expected to cause the failure of the life support device or system, or to affect its safety or effectiveness.

www.fairchildsemi.com

ON Semiconductor and  are trademarks of Semiconductor Components Industries, LLC dba ON Semiconductor or its subsidiaries in the United States and/or other countries. ON Semiconductor owns the rights to a number of patents, trademarks, copyrights, trade secrets, and other intellectual property. A listing of ON Semiconductor's product/patent coverage may be accessed at www.onsemi.com/site/pdf/Patent-Marking.pdf. ON Semiconductor reserves the right to make changes without further notice to any products herein. ON Semiconductor makes no warranty, representation or guarantee regarding the suitability of its products for any particular purpose, nor does ON Semiconductor assume any liability arising out of the application or use of any product or circuit, and specifically disclaims any and all liability, including without limitation special, consequential or incidental damages. Buyer is responsible for its products and applications using ON Semiconductor products, including compliance with all laws, regulations and safety requirements or standards, regardless of any support or applications information provided by ON Semiconductor. "Typical" parameters which may be provided in ON Semiconductor data sheets and/or specifications can and do vary in different applications and actual performance may vary over time. All operating parameters, including "Typicals" must be validated for each customer application by customer's technical experts. ON Semiconductor does not convey any license under its patent rights nor the rights of others. ON Semiconductor products are not designed, intended, or authorized for use as a critical component in life support systems or any FDA Class 3 medical devices or medical devices with a same or similar classification in a foreign jurisdiction or any devices intended for implantation in the human body. Should Buyer purchase or use ON Semiconductor products for any such unintended or unauthorized application, Buyer shall indemnify and hold ON Semiconductor and its officers, employees, subsidiaries, affiliates, and distributors harmless against all claims, costs, damages, and expenses, and reasonable attorney fees arising out of, directly or indirectly, any claim of personal injury or death associated with such unintended or unauthorized use, even if such claim alleges that ON Semiconductor was negligent regarding the design or manufacture of the part. ON Semiconductor is an Equal Opportunity/Affirmative Action Employer. This literature is subject to all applicable copyright laws and is not for resale in any manner.

PUBLICATION ORDERING INFORMATION

LITERATURE FULFILLMENT:

Literature Distribution Center for ON Semiconductor
19521 E. 32nd Pkwy, Aurora, Colorado 80011 USA
Phone: 303-675-2175 or 800-344-3860 Toll Free USA/Canada
Fax: 303-675-2176 or 800-344-3867 Toll Free USA/Canada
Email: orderlit@onsemi.com

N. American Technical Support: 800-282-9855 Toll Free
USA/Canada
Europe, Middle East and Africa Technical Support:
Phone: 421 33 790 2910
Japan Customer Focus Center
Phone: 81-3-5817-1050

ON Semiconductor Website: www.onsemi.com
Order Literature: <http://www.onsemi.com/orderlit>
For additional information, please contact your local
Sales Representative