

General Description

The MIC4681 SuperSwitcher™ is an easy-to-use step-down (buck) voltage-mode switching regulator. The 200kHz MIC4681 achieves over 1A of continuous output current over a 4V to 30V input range in an 8-lead SOP package. The MIC4681 features a high 2.1A minimum current limit, making the device ideal for pulsed current applications such as GSM and TDMA cell phone battery chargers and power supplies. The MIC4681 sustains an output of 4.2V/2A within a typical GSM charging environment.

The MIC4681 has an input voltage range of 4V to 30V, with excellent line, load, and transient response. The regulator performs cycle-by-cycle current limiting and thermal shutdown for protection under fault conditions. In shutdown mode, the regulator draws less than 6μA of standby current.

The MIC4681 SuperSwitcher™ regulator requires a minimum number of external components and can operate using a standard series of inductors and capacitors. Frequency compensation is provided internally for fast transient response and ease of use.

The MIC4681 is available in the 8-lead SOP with a -40°C to +125°C junction temperature range.

Features

- SO-8 package with over 1A continuous output current
- Capable of 2A pulse charging for GSM applications
- All surface mount solution
- Only 4 external components required
- Fixed 200kHz operation
- Output adjustable down to 1.25V
- Internally compensated with fast transient response
- Wide 4V to 30V operating input voltage range
- Less than 6μA typical shutdown-mode current
- Up to 90% efficiency
- Thermal shutdown
- Overcurrent protection

Applications

- Cellular phone battery charger
- Cellular phone power supply
- Simple 1A continuous high-efficiency step-down (buck) regulator
- Replacement of a TO-220 and TO-263 designs
- Positive-to-negative converter (inverting buck-boost)
- Negative boost converter
- Higher output current regulator using external FET

Typical Applications

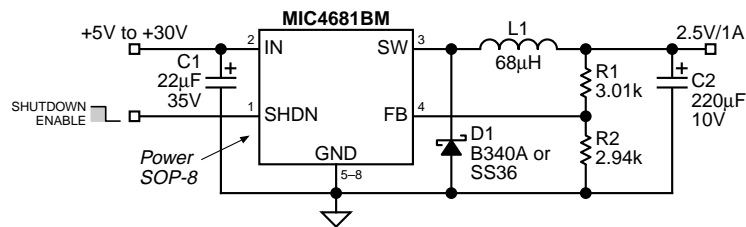

Adjustable Regulator Circuit

Ordering Information

Part Number					
Standard	Lead-Free	Voltage	Frequency	Junction Temp. Range	Package
MIC4681BM	MIC4681YM	Adjustable	400kHz	-40°C to +125°C	8-lead SOP

Pin Configuration

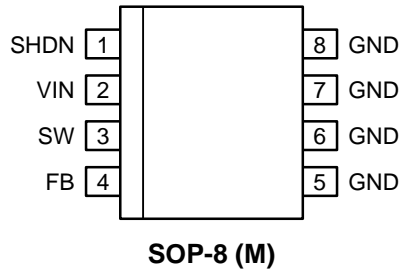

Pin Description

Pin Number	Pin Name	Pin Function
1	SHDN	Shutdown (Input): Logic low enables regulator. Logic high (>2V) shuts down regulator.
2	VIN	Supply Voltage (Input): Unregulated +4V to +30V supply voltage.
3	SW	Switch (Output): Emitter of NPN output switch. Connect to external storage inductor and Shottky diode.
4	FB	Feedback (Input): Connect to 1.23V-tap of voltage-divider network
5-8	GND	Ground

Absolute Maximum Ratings (Note 1)

Supply Voltage (V_{IN}), Note 3	+34V
Shutdown Voltage (V_{SHDN})	-0.3V to +34V
Steady-State Output Switch Voltage (V_{SW})	-1V
Feedback Voltage [Adjustable] (V_{FB})	+12V
Storage Temperature (T_S)	-65°C to +150°C

ESD, **Note 5**

Operating Ratings (Note 2)

Supply Voltage (V_{IN})	+4V to +30V
Junction Temperature (T_J)	+125°C
Package Thermal Resistance (θ_{JA}), Note 6	63°C/W
(θ_{JC}), Note 6	20°C/W

Electrical Characteristics

$V_{IN} = 12V$; $I_{LOAD} = 500mA$; $T_J = 25^\circ C$, **bold** values indicate $-40^\circ C \leq T_J \leq +125^\circ C$, **Note 7**; unless noted.

Parameter	Condition	Min	Typ	Max	Units
Feedback Voltage	($\pm 1\%$)	1.217	1.230	1.243	V
	($\pm 2\%$)	1.205		1.255	V
	$8V \leq V_{IN} \leq 30V$, $0.1A \leq I_{LOAD} \leq 1A$, $V_{OUT} = 5V$	1.193	1.230	1.267	V
		1.180		1.280	V
Maximum Duty Cycle	$V_{FB} = 1.0V$	93	95		%
Output Leakage Current	$V_{IN} = 30V$, $V_{SHDN} = 5V$, $V_{SW} = 0V$		50	500	μA
	$V_{IN} = 30V$, $V_{SHDN} = 5V$, $V_{SW} = -1V$		4	20	mA
Quiescent Current	$V_{FB} = 1.5V$		7	12	mA
Frequency Fold Back			50	110	kHz
Oscillator Frequency		180	200	220	kHz
Saturation Voltage	$I_{OUT} = 1A$		1.4	1.8	V
Short Circuit Current Limit	$V_{FB} = 0V$, see Test Circuit $V_{IN} = 30V$ (Note 8)	2.2	3.4	4.5	A
Standby Quiescent Current	$V_{SHDN} = 5V$ (regulator off)		35	100	μA
	$V_{SHDN} = V_{IN}$		6		μA
Shutdown Input Logic Level	regulator off	2	1.4		V
	regulator on		1.25	0.8	V
Shutdown Input Current	$V_{SHDN} = 5V$ (regulator off)	-10	-0.5	1	μA
	$V_{SHDN} = 0V$ (regulator on)	-10	-1.5	1	μA
Thermal Shutdown @ T_J			160		$^\circ C$

Note 1. Exceeding the absolute maximum rating may damage the device.

Note 2. The device is not guaranteed to function outside its operating rating.

Note 3. Absolute maximum rating is intended for voltage transients only, prolonged dc operation is not recommended.

Note 4. $V_{IN(min)} = V_{OUT} + 2.5V$ or 4V whichever is greater.

Note 5. Devices are ESD sensitive. Handling precautions recommended.

Note 6. Measured on 1" square of 1 oz. copper FR4 printed circuit board connected to the device ground leads.

Note 7. Test at $T_A = +85^\circ C$, guaranteed by design, and characterized to $T_J = +125^\circ C$.

Note 8. Short circuit protection is guaranteed to 30V max.

Test Circuit

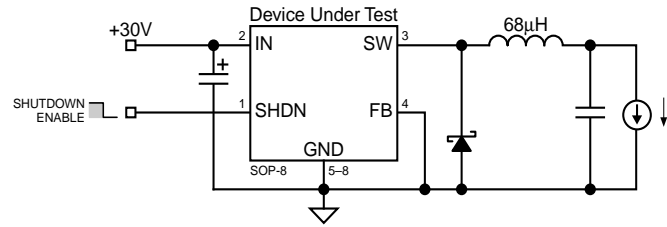

Current Limit Test Circuit

Shutdown Input Behavior

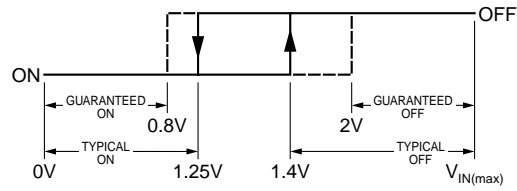

Shutdown Hysteresis

Typical Characteristics

Line Regulation

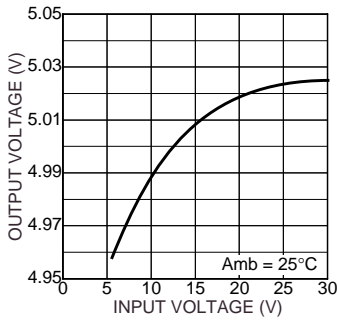

Load Regulation

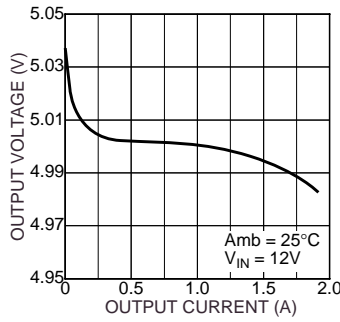

Shutdown Current vs. Input Voltage

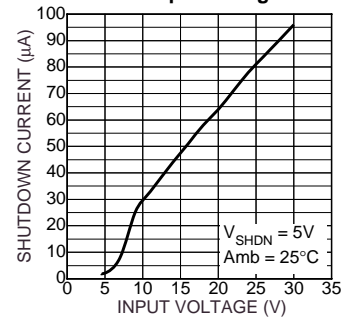

Shutdown Current vs. Input Voltage

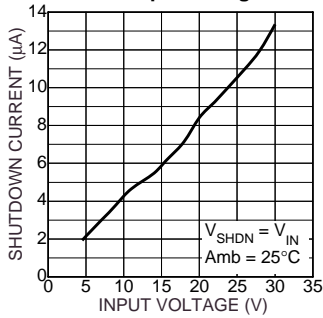

Shutdown Current vs. Temperature

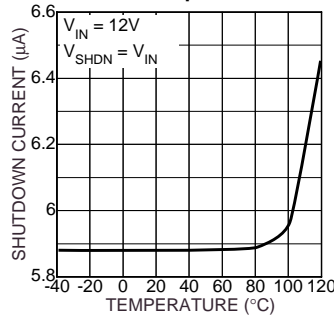

Current Limit Characteristics

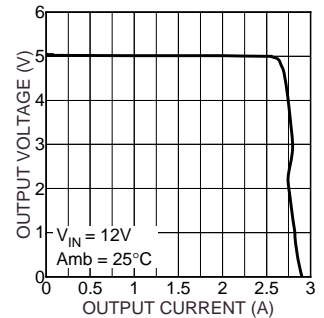

MIC4681BM Frequency vs. Supply Voltage

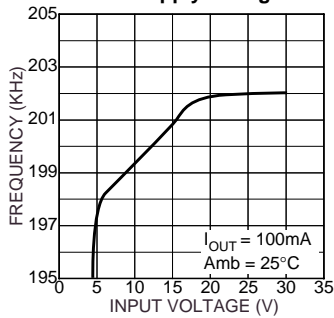

Frequency vs. Temperature

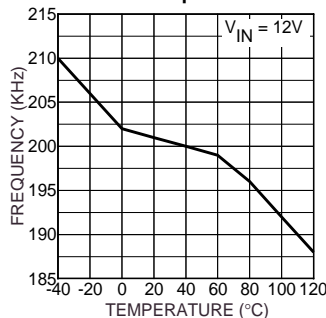

Feedback Voltage vs. Temperature

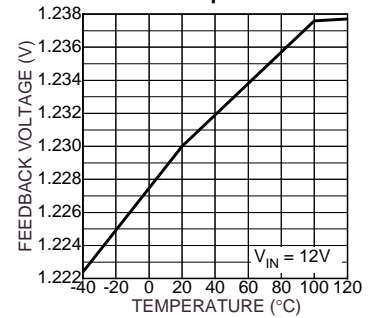

MIC4681 3.3V Output Efficiency

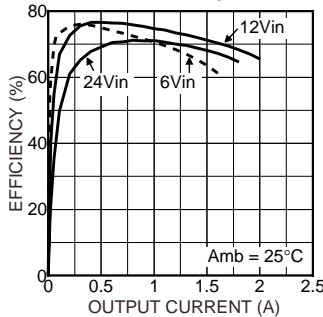

5V Output Efficiency

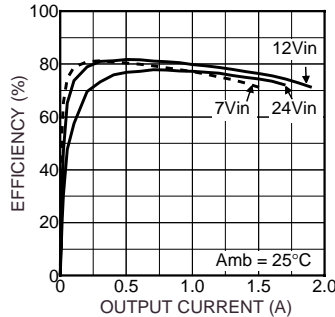

12V Output Efficiency

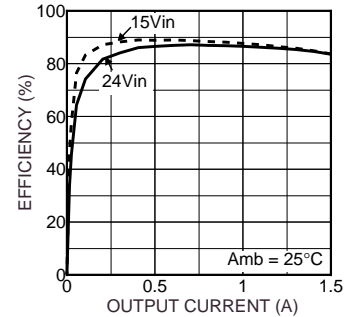

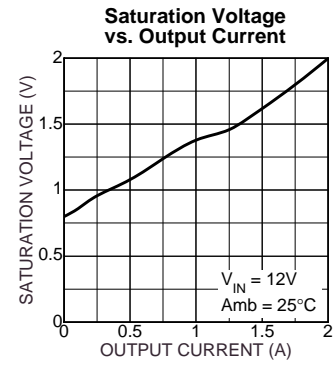
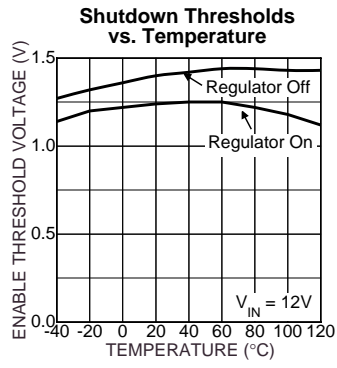

4681BM SOA 5Vout

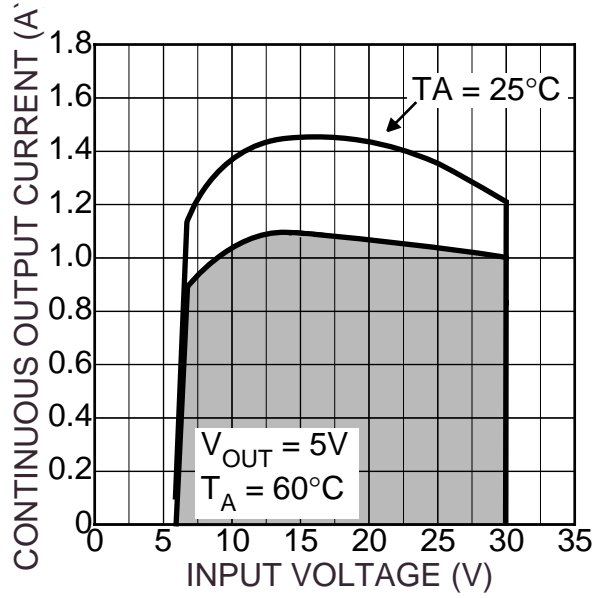

4681BM SOA 3.3Vout

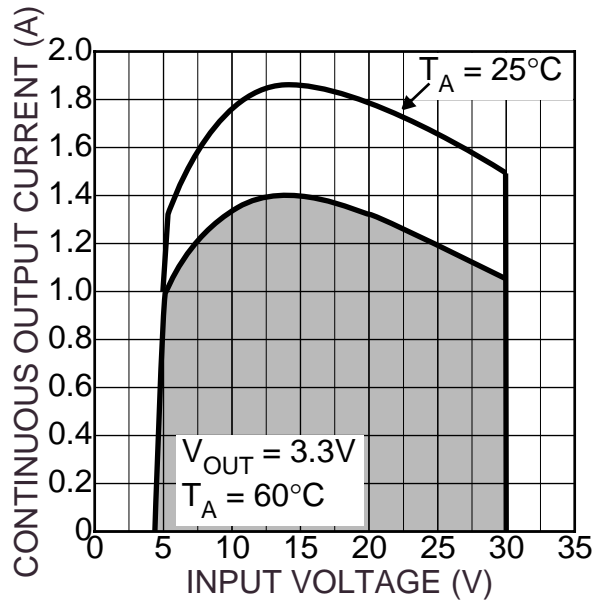

Functional Characteristics

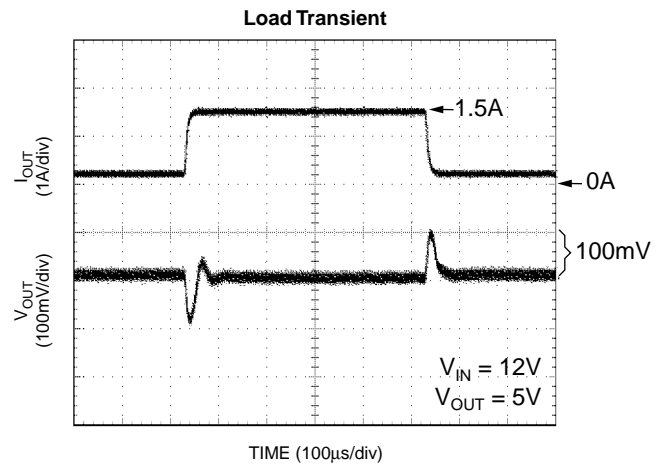
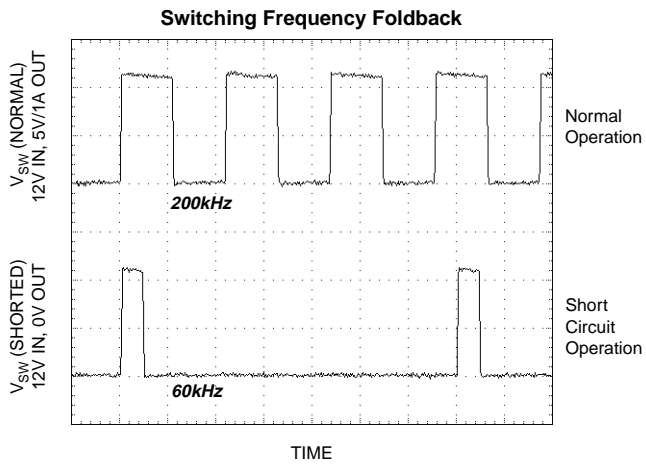

Frequency Foldback

The MIC4681 folds the switching frequency back during a hard short-circuit condition to reduce the energy per cycle and protect the device.

Bode Plots

The following bode plots show that the MIC4681 is stable over all conditions using a **68 μ F inductor (L)** and a **220 μ F output capacitor (C_{OUT})**. To assure stability, it is a good practice to maintain a phase margin of greater than 35°.

No-Load Stability
Phase Margin = 94°

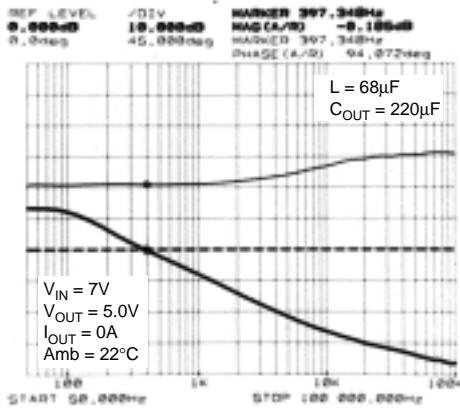

Full-Load Stability
Phase Margin = 74°

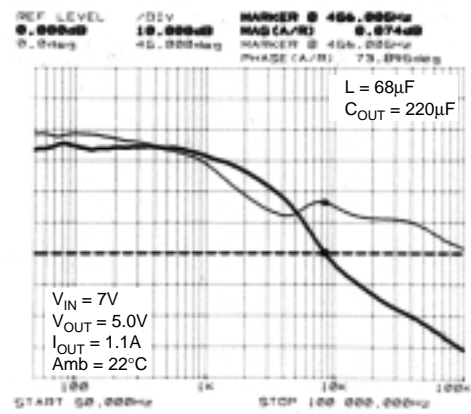

No-Load Stability
Phase Margin = 102°

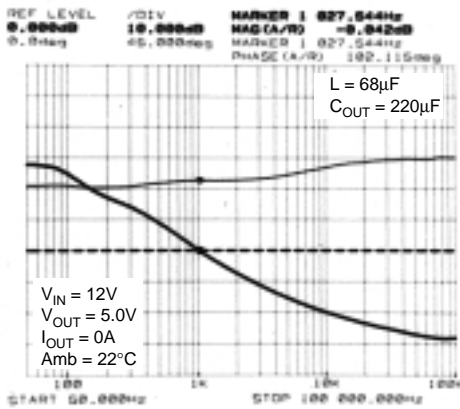

Full-Load Stability
Phase Margin = 53°

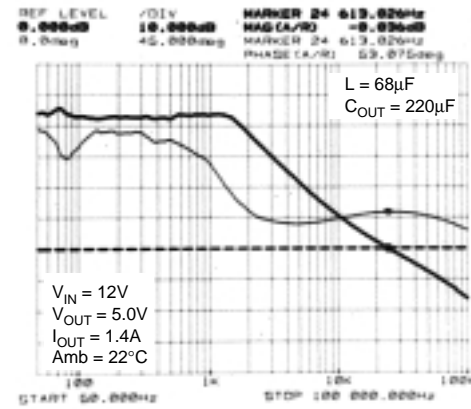

No-Load Stability
Phase Margin = 118°

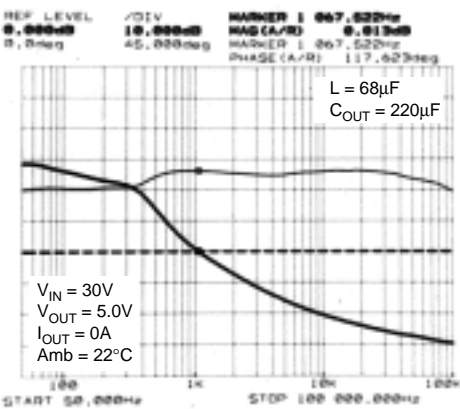

Full-Load Stability
Phase Margin = 59°

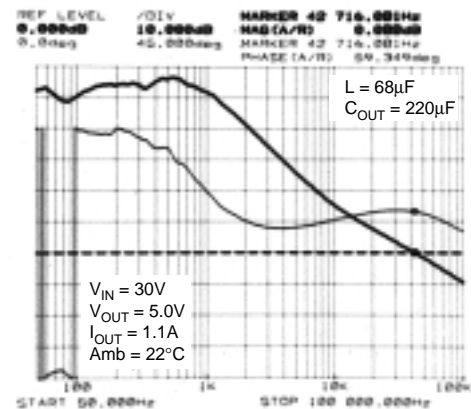

Block Diagrams

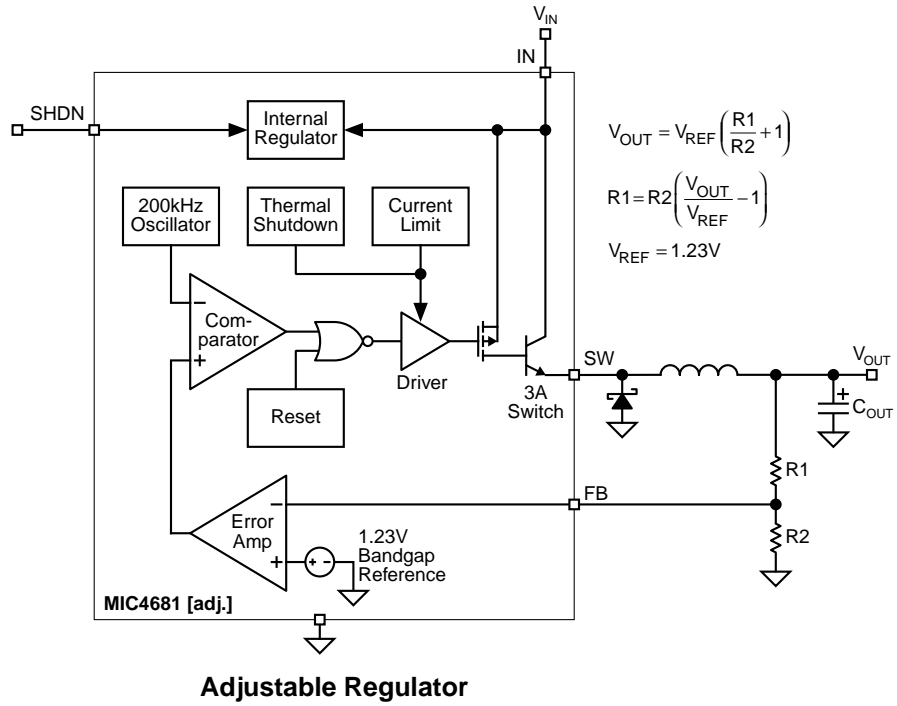

Functional Description

The MIC4681 is a variable duty cycle switch-mode regulator with an internal power switch. Refer to the block diagrams.

Supply Voltage

The MIC4681 operates from a +4V to +30V unregulated input. Highest efficiency operation is from a supply voltage around +12V. See the efficiency curves on page 6.

Enable/Shutdown

The shutdown (SHDN) input is TTL compatible. Ground the input if unused. A logic-low enables the regulator. A logic-high shuts down the internal regulator which reduces the current to typically 35 μ A when $V_{SHDN} = V_{IN} = 12V$ and 6 μ A when $V_{SHDN} = 5V$. See "Shutdown Input Behavior: Shutdown Hysteresis."

Feedback

Require an external resistive voltage divider from the output voltage to ground, center tapped to the FB pin. See Figure 1b for recommended resistor values.

Duty Cycle Control

A fixed-gain error amplifier compares the feedback signal with a 1.23V bandgap voltage reference. The resulting error amplifier output voltage is compared to a 200kHz sawtooth waveform to produce a voltage controlled variable duty cycle output.

A higher feedback voltage increases the error amplifier output voltage. A higher error amplifier voltage (comparator

inverting input) causes the comparator to detect only the peaks of the sawtooth, reducing the duty cycle of the comparator output. A lower feedback voltage increases the duty cycle. The MIC4681 uses a voltage-mode control architecture.

Output Switching

When the internal switch is ON, an increasing current flows from the supply V_{IN} , through external storage inductor L1, to output capacitor C_{OUT} and the load. Energy is stored in the inductor as the current increases with time.

When the internal switch is turned OFF, the collapse of the magnetic field in L1 forces current to flow through fast recovery diode D1, charging C_{OUT} .

Output Capacitor

External output capacitor C_{OUT} provides stabilization and reduces ripple. See "Bode Plots" for additional information.

Return Paths

During the ON portion of the cycle, the output capacitor and load currents return to the supply ground. During the OFF portion of the cycle, current is being supplied to the output capacitor and load by storage inductor L1, which means that D1 is part of the high-current return path.

Applications Information

Adjustable Regulators

Adjustable regulators require a 1.23V feedback signal. Recommended voltage-divider resistor values for common output voltages are included in Figure 1b.

For other voltages, the resistor values can be determined using the following formulas:

$$V_{OUT} = V_{REF} \left(\frac{R1}{R2} + 1 \right)$$

$$R1 = R2 \left(\frac{V_{OUT}}{V_{REF}} - 1 \right)$$

$$V_{REF} = 1.23V$$

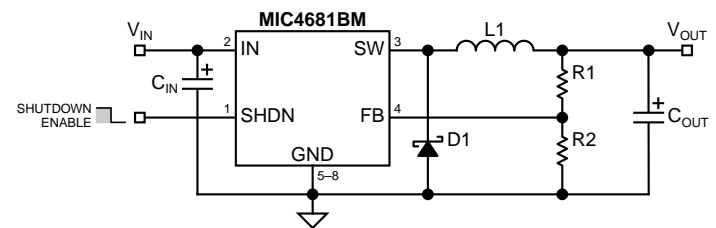

Figure 1a. Adjustable Regulator Circuit

V_{OUT}	$R1^*$	$R2^*$	C_{IN}	D1	L1	C_{OUT}
1.8V	3.01k	6.49k	22 μ F 35V Vishay Dale 593D226X035E2T	3A 40V Schottky B340A Vishay-Diode, Inc.*** or SS36 General Semiconductor	68 μ H 2.0A Coiltronics UP3B-680 or Sumida CDRH127-680MC**	220 μ F 10V Vishay Dale 594D227X0010D2
2.5V	3.01k	2.94k				
3.3V	3.01k	1.78k				
5.0V	3.01k	976 Ω				
6.0V	3.01k	787 Ω				

* All resistors 1%

** shielded magnetics for low RFI applications

*** Vishay-Diode, Inc. (805) 446-4800

Figure 1b. Recommended Components for Common Output Voltages

Thermal Considerations

The MIC4681 SuperSwitcher™ features the power-SOP-8. This package has a standard 8-lead small-outline package profile, but with much higher power dissipation than a standard SOP-8. Micrel's MIC4681 SuperSwitcher™ family are the first dc-to-dc converters to take full advantage of this package.

The reason that the power SOP-8 has higher power dissipation (lower thermal resistance) is that pins 5 through 8 and the die-attach paddle are a single piece of metal. The die is attached to the paddle with thermally conductive adhesive. This provides a low thermal resistance path from the junction of the die to the ground pins. This design significantly improves package power dissipation by allowing excellent heat transfer through the ground leads to the printed circuit board.

One limitation of the maximum output current on any MIC4681 design is the junction-to-ambient thermal resistance (θ_{JA}) of the design (package and ground plane).

Examining θ_{JA} in more detail:

$$\theta_{JA} = (\theta_{JC} + \theta_{CA})$$

where:

θ_{JC} = junction-to-case thermal resistance

θ_{CA} = case-to-ambient thermal resistance

θ_{JC} is a relatively constant 20°C/W for a power SOP-8.

θ_{CA} is dependent on layout and is primarily governed by the connection of pins 5 through 8 to the ground plane. The purpose of the ground plane is to function as a heat sink.

θ_{JA} is ideally 63°C/W, but will vary depending on the size of the ground plane to which the power SOP-8 is attached.

Determining Ground-Plane Heat-Sink Area

There are two methods of determining the minimum ground plane area required by the MIC4681.

Quick Method

Make sure that MIC4681 pins 5 through 8 are connected to a ground plane with a minimum area of 6cm². This ground plane should be as close to the MIC4681 as possible. The area may be distributed in any shape around the package or on any pcb layer as long as there is good thermal contact to pins 5 through 8. This ground plane area is more than sufficient for most designs.

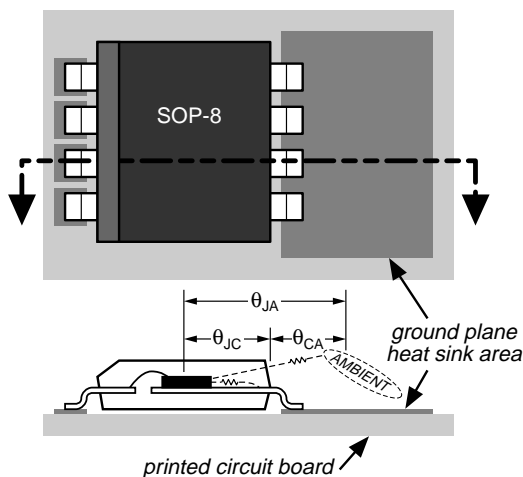

Figure 2. Power SOP-8 Cross Section

Minimum Copper/Maximum Current Method

Using Figure 3, for a given input voltage range, determine the minimum ground-plane heat-sink area required for the application's maximum continuous output current. Figure 3 assumes a constant die temperature of 75°C above ambient.

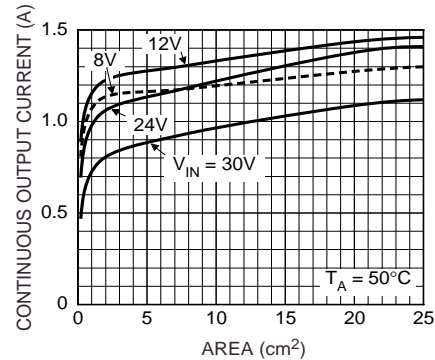

Figure 3. Output Current vs. Ground Plane Area

When designing with the MIC4681, it is a good practice to connect pins 5 through 8 to the largest ground plane that is practical for the specific design.

Checking the Maximum Junction Temperature:

For this example, with an output power (P_{OUT}) of 5W, (5V output at 1A maximum with $V_{IN} = 12V$) and 65°C maximum ambient temperature, what is the maximum junction temperature?

Referring to the "Typical Characteristics: 5V Output Efficiency" graph, read the efficiency (η) for 1A output current at $V_{IN} = 12V$ or perform your own measurement.

$$\eta = 79\%$$

The efficiency is used to determine how much of the output power (P_{OUT}) is dissipated in the regulator circuit (P_D).

$$P_D = \frac{P_{OUT}}{\eta} - P_{OUT}$$

$$P_D = \frac{5W}{0.79} - 5W$$

$$P_D = 1.33W$$

A worst-case rule of thumb is to assume that 80% of the total output power dissipation is in the MIC4681 ($P_{D(IC)}$) and 20% is in the diode-inductor-capacitor circuit.

$$P_{D(IC)} = 0.8 P_D$$

$$P_{D(IC)} = 0.8 \times 1.33W$$

$$P_{D(IC)} = 1.064W$$

Calculate the worst-case junction temperature:

$$T_J = P_{D(IC)} \theta_{JC} + (T_C - T_A) + T_{A(max)}$$

where:

T_J = MIC4681 junction temperature

$P_{D(IC)}$ = MIC4681 power dissipation

θ_{JC} = junction-to-case thermal resistance.

The θ_{JC} for the MIC4681's power-SOP-8 is approximately 20°C/W.

T_C = "pin" temperature measurement taken at the entry point of pins 6 or 7

T_A = ambient temperature

$T_{A(max)}$ = maximum ambient operating temperature for the specific design.

Calculating the maximum junction temperature given a maximum ambient temperature of 65°C:

$$T_J = 1.064 \times 20^\circ\text{C/W} + (45^\circ\text{C} - 25^\circ\text{C}) + 65^\circ\text{C}$$

$$T_J = 106.3^\circ\text{C}$$

This value is within the allowable maximum operating junction temperature of 125°C as listed in “Operating Ratings.” Typical thermal shutdown is 160°C and is listed in “Electrical Characteristics.”

Layout Considerations

Layout is very important when designing any switching regulator. Rapidly changing currents through the printed circuit board traces and stray inductance can generate voltage transients which can cause problems.

To minimize stray inductance and ground loops, keep trace lengths, indicated by the heavy lines in Figure 5, as short as possible. For example, keep D1 close to pin 3 and pins 5 through 8, keep L1 away from sensitive node FB, and keep

C_{IN} close to pin 2 and pins 5 through 8. See “Applications Information: Thermal Considerations” for ground plane layout.

The feedback pin should be kept as far way from the switching elements (usually L1 and D1) as possible.

A circuit with sample layouts are provided. See Figures 6a through 6e. Gerber files are available upon request.

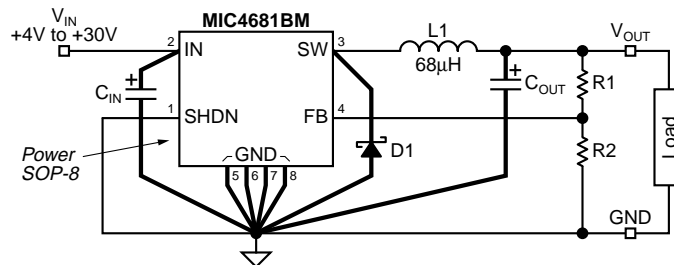
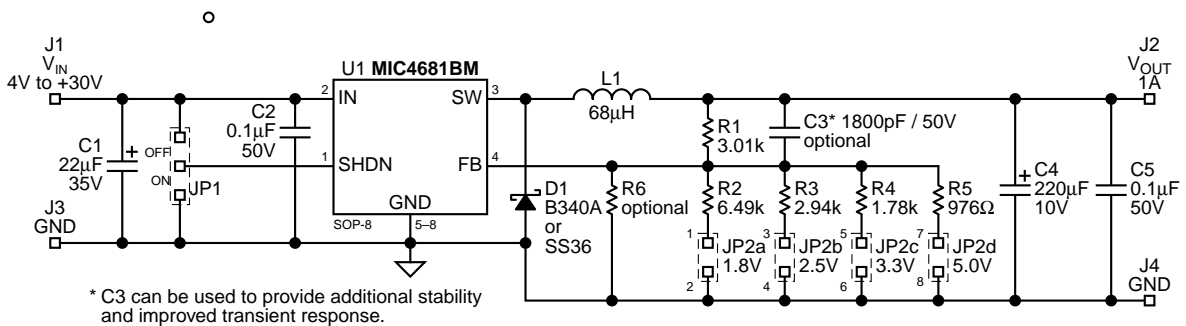

Figure 5. Critical Traces for Layout



* C3 can be used to provide additional stability and improved transient response.

Figure 6a. Evaluation Board Schematic Diagram

Printed Circuit Board Layouts

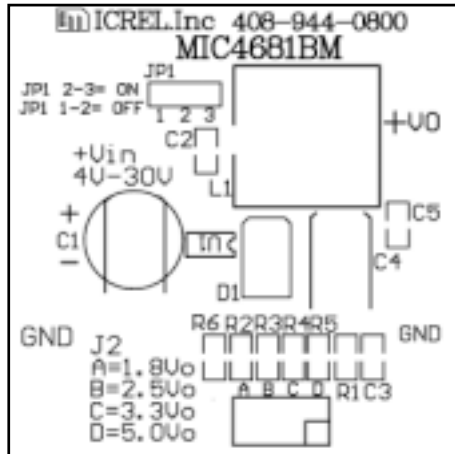

Figure 6b. Top-Side Silk Screen

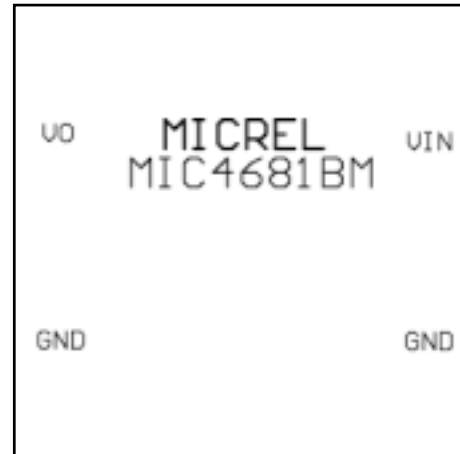

Figure 6d. Bottom-Side Silk Screen



Figure 6c. Top-Side Copper

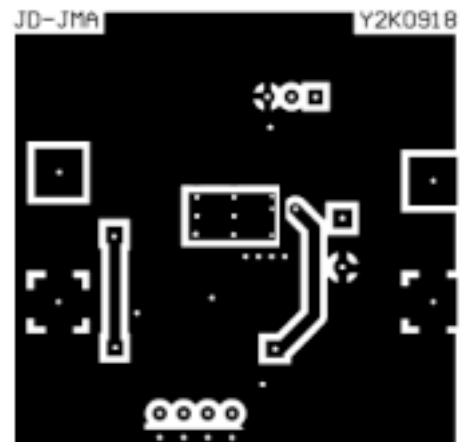

Figure 6e. Bottom-Side Copper

Abbreviated Bill of Material (Critical Components)

Reference	Part Number	Manufacturer	Description	Qty
C1	593D226X035E2T	Vishay Dale ¹	22 μ F / 35V	1
C4	594D227X0010D2	Vishay Dale ¹	220 μ F / 10V	1
C2,C5	VJ0805Y104KXXMB	Vishay Dale ¹	0.1 / 50V	1
D1	340A	Diodes Inc. ²	Schottky Diode 3A, 40V	1
L1	CDRH127-680MC	Sumida ³	68 μ H, I _{SAT} 2.1A, shielded	1
U1	MIC4681BM	Micrel Semiconductor ⁴	200kHz Super Switcher™ SOIC 8 pin	1

¹ Vishay Dale, Inc., tel: 1 877-847-4291, <http://www.vishay.com>

² Diodes Inc, tel: (805) 446-4800, <http://www.diodes.com>

³ Sumida, tel: (408) 982-9960, <http://www.sumida.com>

⁴ Micrel, tel: (408) 944-0800, <http://www.micrel.com>

Applications Circuits*

For continuously updated circuits using the MIC4681, see *Application Hint 37* at www.micrel.com.

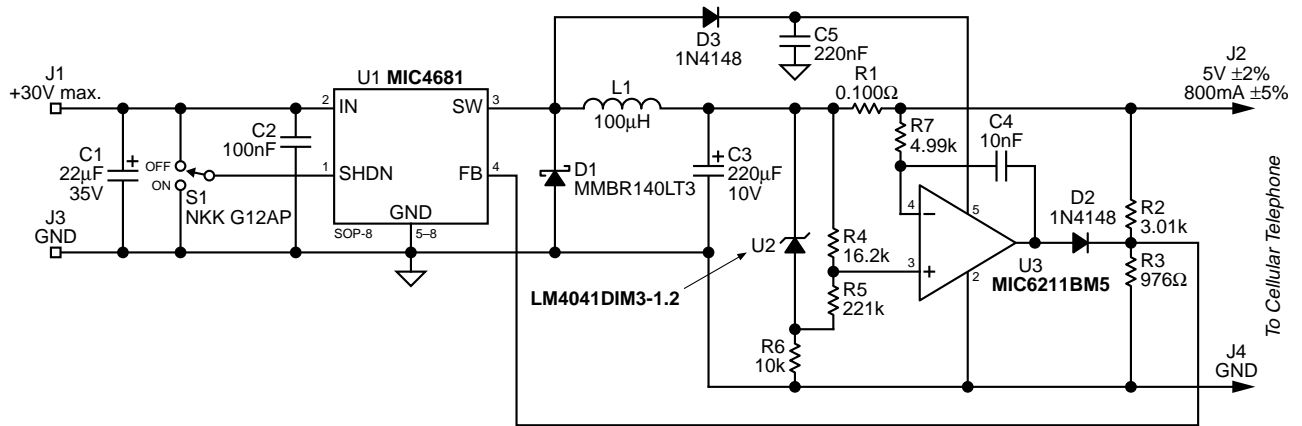

Figure 7. Constant Current and Constant Voltage Battery Charger

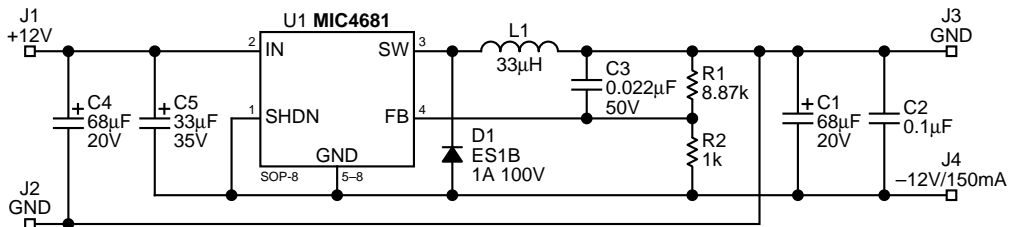

Figure 8. +12V to -12V/150mA Buck-Boost Converter

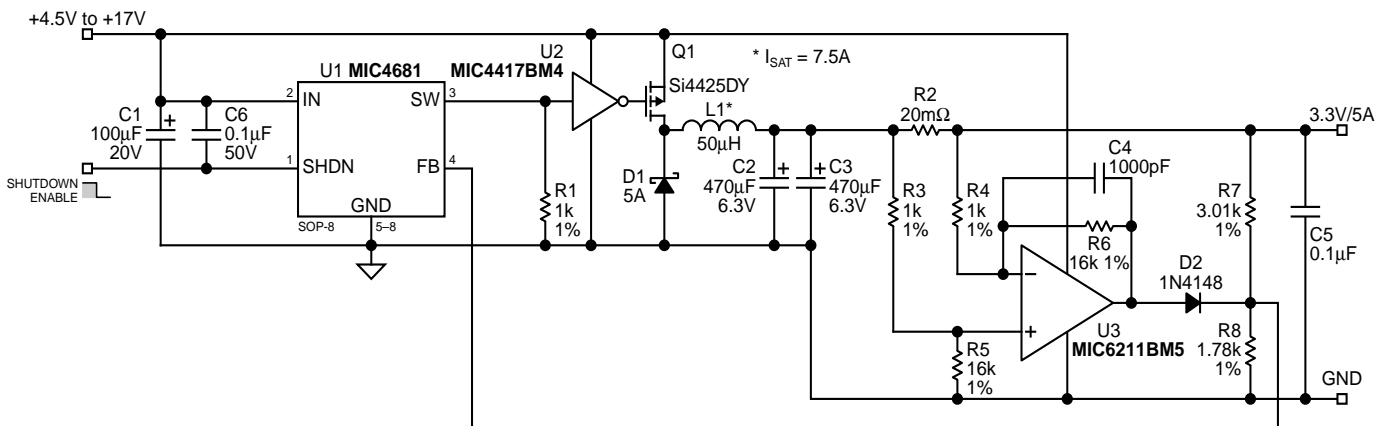
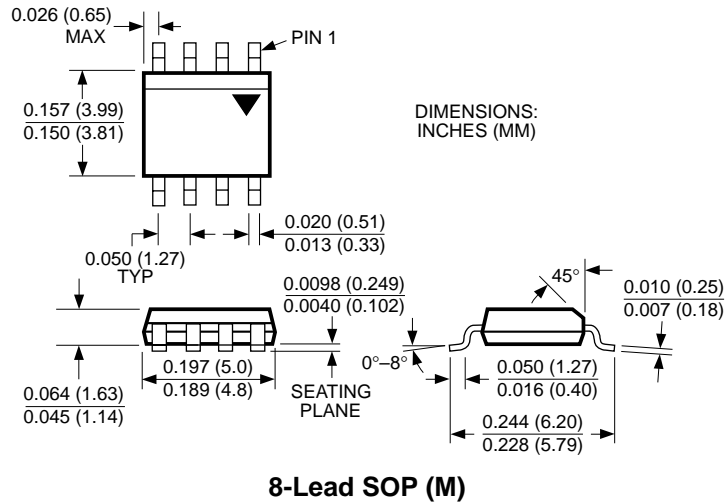

Figure 9. 5V to 3.3V/5A Power Supply

* See Application Hint 37 at www.micrel.com for bills of material.

Package Information



MICREL, INC. 2180 FORTUNE DRIVE SAN JOSE, CA 95131 USA

TEL + 1 (408) 944-0800 FAX + 1 (408) 474-1000 WEB <http://www.micrel.com>

The information furnished by Micrel in this data sheet is believed to be accurate and reliable. However, no responsibility is assumed by Micrel for its use. Micrel reserves the right to change circuitry and specifications at any time without notification to the customer.

Micrel Products are not designed or authorized for use as components in life support appliances, devices or systems where malfunction of a product can reasonably be expected to result in personal injury. Life support devices or systems are devices or systems that (a) are intended for surgical implant into the body or (b) support or sustain life, and whose failure to perform can be reasonably expected to result in a significant injury to the user. A Purchaser's use or sale of Micrel Products for use in life support appliances, devices or systems is at Purchaser's own risk and Purchaser agrees to fully indemnify Micrel for any damages resulting from such use or sale.

© 2005 Micrel, Incorporated.