

P6KE SERIES

List

List..... 1

Package outline..... 2

Features..... 2

Mechanical data..... 2

Maximum ratings 2

Electrical characteristics..... 3

Rating and characteristic curves..... 4

Pinning information..... 5

Taping & bulk specifications for AXIAL devices..... 5

Suggested thermal profiles for soldering processes..... 6

High reliability test capabilities..... 7

P6KE SERIES

600W Axial Lead Transient Voltage Suppressors - 6.8V-600V

Features

- Axial lead type devices for through hole design.
- 600W peak pulse power capability with a 10/1000us waveform, repetition rate (duty cycle): 0.01%.
- Excellent clamping capability.
- Low incremental surge resistance.
- Fast response time from 0V to V_{BR} , typically less than 1 pS for uni-directional & 5 nS for bi-directional types.
- Ultra high-speed switching.
- Glass passivated chip junction.
- Lead-free parts meet environmental standards of MIL-STD-19500 /228
- Suffix "-H" indicates Halogen free parts, ex. P6KE6.8A-H

Mechanical data

- Epoxy : UL94-V0 rated flame retardant
- Case : Molded plastic, DO-15
- Lead : Axial leads, solderable per MIL-STD-202, Method 208 guaranteed
- Polarity: Color band denotes cathode end
- Mounting Position : Any
- Weight : Approximated 0.40 gram

Package outline

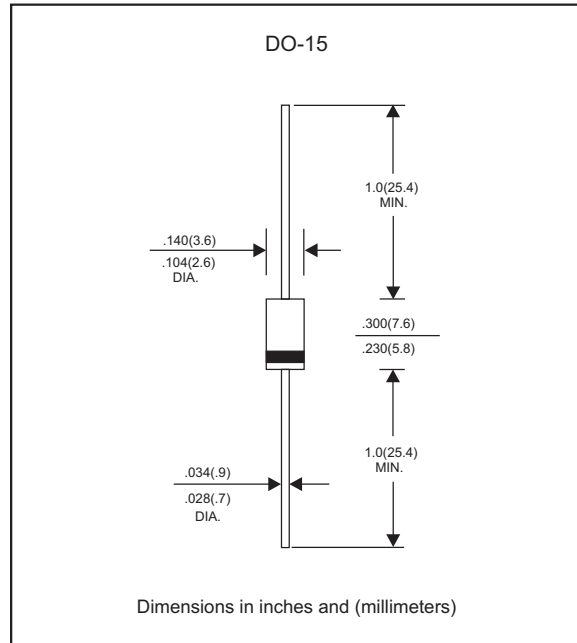

Maximum ratings (AT $T_A=25^\circ\text{C}$ unless otherwise noted)

PARAMETER	CONDITIONS	Symbol	MIN.	TYP.	MAX.	UNIT
Peak power dissipation	with a 10/1000 us waveform, Note 1 & Fig. 1	P_{PPM}			600	W
Peak pulse current	with a 10/1000 us waveform	I_{PPM}	See table 1			A
Steady state power dissipation	at $T_L=75^\circ\text{C}$ lead length 0.375" (9.5 mm)	$P_{M(AV)}$			5.0	W
Peak forward surge current	8.3ms single half sine-wave (JEDEC Method), note 2	I_{FSM}			100	A
Maximum instantaneous forward voltage	for uni-directional types only, at 50A, see note 3	V_F			3.5/5.0	V
Operating junction temperature range		T_J	-55		+150	$^\circ\text{C}$
Storage temperature range		T_{STG}	-55		+150	$^\circ\text{C}$

Note 1. Non-repetitive current pulse, per Fig. 3 and derated above $T_A=25^\circ\text{C}$ per Fig. 2

2. Measured on 8.3 ms single half sine-wave or equivalent square wave, duty cycle=4 pulses per minute maximum

3. $V_F < 3.5\text{V}$. for devices of $V_{BR} < 200\text{V}$, and $V_F < 5.0\text{V}$. for devices of $V_{BR} > 201\text{V}$

Electrical characteristics (at $T_A=25^{\circ}\text{C}$ unless otherwise noted) **Table 1**

Part No. (Uni)	Part No. (Bi)	Reverse Stand-off Voltage	Breakdown Voltage @ I_T		Test Current	Maximum Clamping Voltage @ I_{PP}		Maximum Reverse Leakage Current	Marking Code	
		V_{RWM}	$V_{BR\ Min}$	$V_{BR\ Max}$	I_T	$V_C@I_{PP}$		$I_R@V_{RWM}$	Uni	Bi
		Volts	Volts	Volts	mA	Volts	$I_{PP}(A)$	$I_R(\mu A)$		
P6KE6.8A	P6KE6.8CA	5.80	6.45	7.14	10	10.5	57.0	1000	P6KE6.8A	P6KE6.8CA
P6KE7.5A	P6KE7.5CA	6.40	7.13	7.88	10	11.3	53.0	500	P6KE7.5A	P6KE7.5CA
P6KE8.2A	P6KE8.2CA	7.02	7.79	8.61	10	12.1	50.0	200	P6KE8.2A	P6KE8.2CA
P6KE9.1A	P6KE9.1CA	7.78	8.65	9.55	1.0	13.4	45.0	50	P6KE9.1A	P6KE9.1CA
P6KE10A	P6KE10CA	8.55	9.50	10.5	1.0	14.5	41.0	10	P6KE10A	P6KE10CA
P6KE11A	P6KE11CA	9.40	10.5	11.6	1.0	15.6	38.0	5	P6KE11A	P6KE11CA
P6KE12A	P6KE12CA	10.2	11.4	12.6	1.0	16.7	36.0	5	P6KE12A	P6KE12CA
P6KE13A	P6KE13CA	11.1	12.4	13.7	1.0	18.2	33.0	5	P6KE13A	P6KE13CA
P6KE15A	P6KE15CA	12.8	14.3	15.8	1.0	21.2	28.0	5	P6KE15A	P6KE15CA
P6KE16A	P6KE16CA	13.6	15.2	16.8	1.0	22.5	27.0	5	P6KE16A	P6KE16CA
P6KE18A	P6KE18CA	15.3	17.1	18.9	1.0	25.5	24.0	5	P6KE18A	P6KE18CA
P6KE20A	P6KE20CA	17.1	19.0	21.0	1.0	27.7	22.0	5	P6KE20A	P6KE20CA
P6KE22A	P6KE22CA	18.8	20.9	23.1	1.0	30.6	20.0	5	P6KE22A	P6KE22CA
P6KE24A	P6KE24CA	20.5	22.8	25.2	1.0	33.2	18.0	5	P6KE24A	P6KE24CA
P6KE27A	P6KE27CA	23.1	25.7	28.4	1.0	37.5	16.0	5	P6KE27A	P6KE27CA
P6KE30A	P6KE30CA	25.6	28.5	31.5	1.0	41.4	14.4	5	P6KE30A	P6KE30CA
P6KE33A	P6KE33CA	28.2	31.4	34.7	1.0	45.7	13.2	5	P6KE33A	P6KE33CA
P6KE36A	P6KE36CA	30.8	34.2	37.8	1.0	49.9	12.0	5	P6KE36A	P6KE36CA
P6KE39A	P6KE39CA	33.3	37.1	41.0	1.0	53.9	11.2	5	P6KE39A	P6KE39CA
P6KE43A	P6KE43CA	36.8	40.9	45.2	1.0	59.3	10.1	5	P6KE43A	P6KE43CA
P6KE47A	P6KE47CA	40.2	44.7	49.4	1.0	64.8	9.3	5	P6KE47A	P6KE47CA
P6KE51A	P6KE51CA	43.6	48.5	53.6	1.0	70.1	8.6	5	P6KE51A	P6KE51CA
P6KE56A	P6KE56CA	47.8	53.2	58.8	1.0	77.0	7.8	5	P6KE56A	P6KE56CA
P6KE62A	P6KE62CA	53.0	58.9	65.1	1.0	85.0	7.1	5	P6KE62A	P6KE62CA
P6KE68A	P6KE68CA	58.1	64.6	71.4	1.0	92.0	6.5	5	P6KE68A	P6KE68CA
P6KE75A	P6KE75CA	64.1	71.3	78.8	1.0	103.0	5.8	5	P6KE75A	P6KE75CA
P6KE82A	P6KE82CA	70.1	77.9	86.1	1.0	113.0	5.3	5	P6KE82A	P6KE82CA
P6KE91A	P6KE91CA	77.8	86.5	95.5	1.0	125.0	4.8	5	P6KE91A	P6KE91CA
P6KE100A	P6KE100CA	85.5	95.0	105.0	1.0	137.0	4.4	5	P6KE100A	P6KE100CA
P6KE110A	P6KE110CA	94.0	105.0	116.0	1.0	152.0	4.0	5	P6KE110A	P6KE110CA
P6KE120A	P6KE120CA	102.0	114.0	126.0	1.0	165.0	3.6	5	P6KE120A	P6KE120CA
P6KE130A	P6KE130CA	111.0	124.0	137.0	1.0	179.0	3.3	5	P6KE130A	P6KE130CA
P6KE150A	P6KE150CA	128.0	143.0	158.0	1.0	207.0	2.9	5	P6KE150A	P6KE150CA
P6KE160A	P6KE160CA	136.0	152.0	168.0	1.0	219.0	2.7	5	P6KE160A	P6KE160CA
P6KE170A	P6KE170CA	145.0	162.0	179.0	1.0	234.0	2.6	5	P6KE170A	P6KE170CA
P6KE180A	P6KE180CA	154.0	171.0	189.0	1.0	246.0	2.4	5	P6KE180A	P6KE180CA
P6KE200A	P6KE200CA	171.0	190.0	210.0	1.0	274.0	2.2	5	P6KE200A	P6KE200CA
P6KE220A	P6KE220CA	185.0	209.0	231.0	1.0	328.0	1.83	5	P6KE220A	P6KE220CA
P6KE250A	P6KE250CA	214.0	237.0	263.0	1.0	344.0	1.75	5	P6KE250A	P6KE250CA
P6KE300A	P6KE300CA	256.0	285.0	315.0	1.0	414.0	1.45	5	P6KE300A	P6KE300CA
P6KE350A	P6KE350CA	300.0	332.0	368.0	1.0	482.0	1.25	5	P6KE350A	P6KE350CA
P6KE400A	P6KE400CA	342.0	380.0	420.0	1.0	548.0	1.10	5	P6KE400A	P6KE400CA
P6KE440A	P6KE440CA	376.0	418.0	462.0	1.0	602.0	1.00	5	P6KE440A	P6KE440CA
P6KE480A	P6KE480CA	408.0	456.0	504.0	1.0	658.0	0.90	5	P6KE480A	P6KE480CA
P6KE510A	P6KE510CA	434.0	485.0	536.0	1.0	698.0	0.85	5	P6KE510A	P6KE510CA
P6KE520A	P6KE520CA	442.0	494.0	546.0	1.0	718.0	0.83	5	P6KE520A	P6KE520CA
P6KE530A	P6KE530CA	451.0	503.5	556.5	1.0	725.0	0.82	5	P6KE530A	P6KE530CA
P6KE540A	P6KE540CA	459.0	513.0	567.0	1.0	740.0	0.81	5	P6KE540A	P6KE540CA
P6KE550A	P6KE550CA	495.0	522.5	577.5	1.0	760.0	0.78	5	P6KE550A	P6KE550CA
P6KE600A	P6KE600CA	510.0	570.0	630.0	1.0	828.0	0.72	5	P6KE600A	P6KE600CA

- Note 1. V_{BR} measured after I_T applied for 300us, I_T =square wave pulse or equivalent
2. Surge current waveform per Fig. 3 and derated per Fig. 2
3. For bi-directional types having V_{RWM} of 10 volts and less, the I_R limit is doubled
4. Suffix 'C' denotes bi-directional devices. Suffix 'A' denotes 5% tolerance devices, no suffix denotes 10% tolerance devices.
5. All terms and symbols are consistent with ANS/IEEE C62.35



Rating and characteristic curves (P6KE SERIES)

Fig.1 - PEAK PULSE POWER RATING CURVE

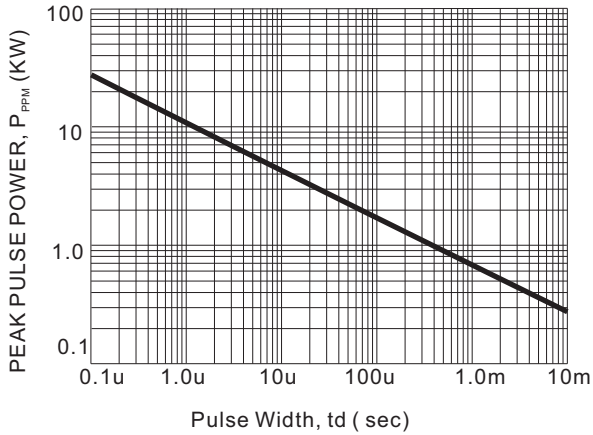

Fig.2 - PULSE DERATING CURVE

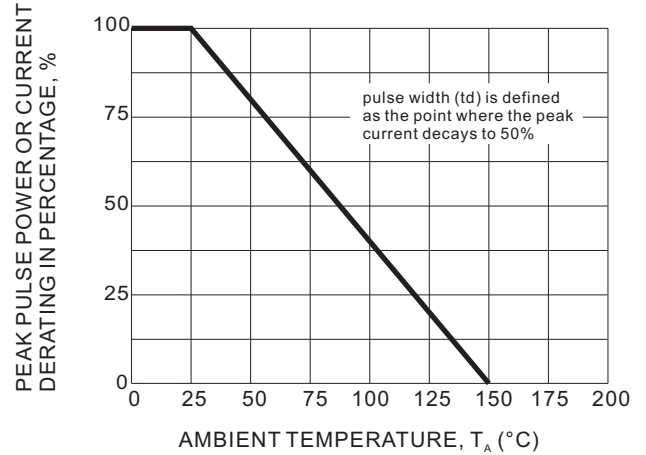

Fig.3 - PULSE WAVEFORM

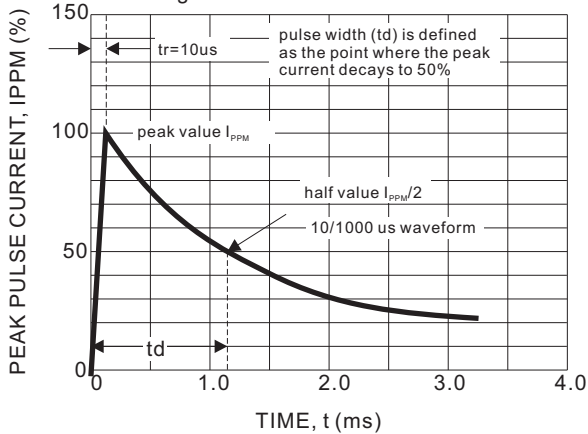

Fig.4 - TYPICAL JUNCTION CAPACITANCE

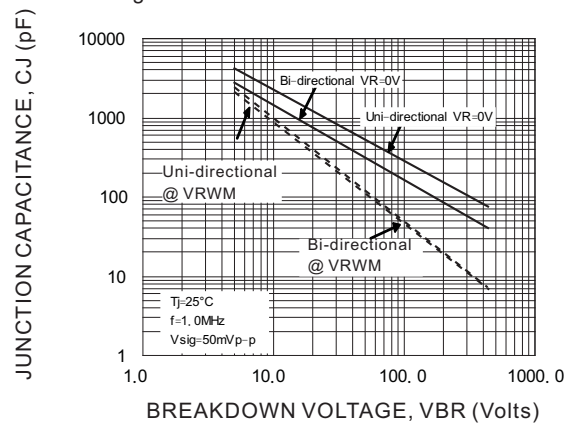

Fig.5 - STEADY STATE POWER DERATING CURVE

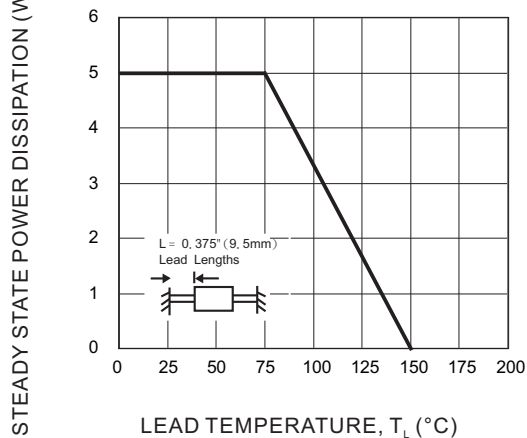
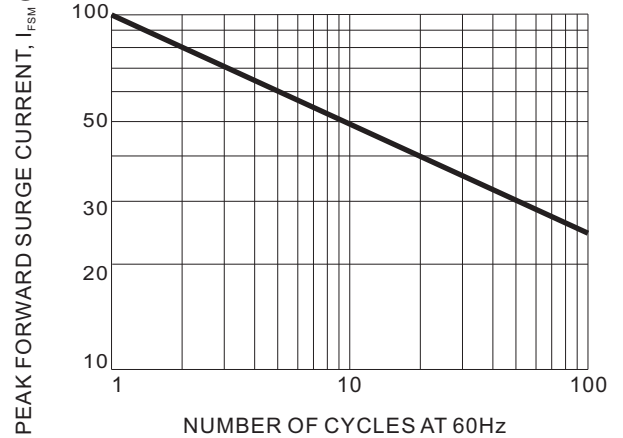





Fig.6 - MAXIMUM NON-REPETITIVE FORWARD SURGE CURRENT



P6KE SERIES

Pinning information

Pin	Simplified outline	Symbol
Uni-Directional Pin1 cathode Pin2 anode		
Bi-Directional		

Taping & bulk specifications for AXIAL devices

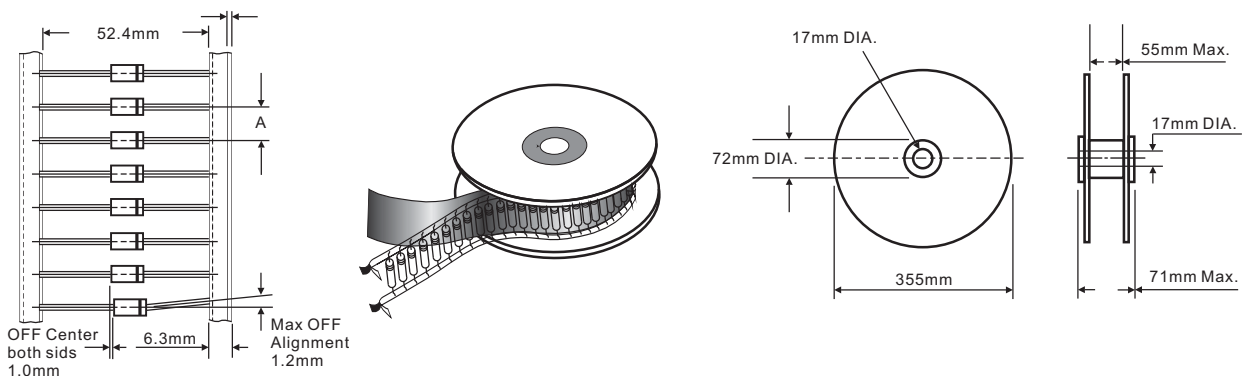

REEL PACKING

DEVICE CASE TYPE	Q'TY 1 (PCS / REEL)	COMPONENT SPACING "A" in FIG. A	CARTON SIZE (m/m)	Q'TY 2 (PCS / CARTON)	APPROX. CROSS WEIGHT(kg)
DO-15	4,000	5 mm	360 * 340 * 370	16,000	9.9

AMMO PACKING

DEVICE CASE TYPE	Q'TY 1 (PCS / BOX)	INNER BOX SIZE (m/m)	CARTON SIZE (m/m)	Q'TY 2 (PCS / CARTON)	APPROX. CROSS WEIGHT(kg)
DO-15	2,000	260 * 83 * 160	440 * 270 * 340	20,000	11.0
	3,000	260 * 83 * 160	440 * 270 * 340	30,000	14.3

P6KE SERIES

BULK PACKING

DEVICE CASE TYPE	Q'TY 1 (PCS / BOX)	INNER BOX SIZE (m/m)	CARTON SIZE (m/m)	Q'TY 2 (PCS / CARTON)	APPROX. CROSS WEIGHT(kg)
DO-15	500	194 * 84 * 20	465 * 220 * 260	25,000	12.9

Suggested thermal profiles for soldering processes

1. Lead free temperature profile wave-soldering

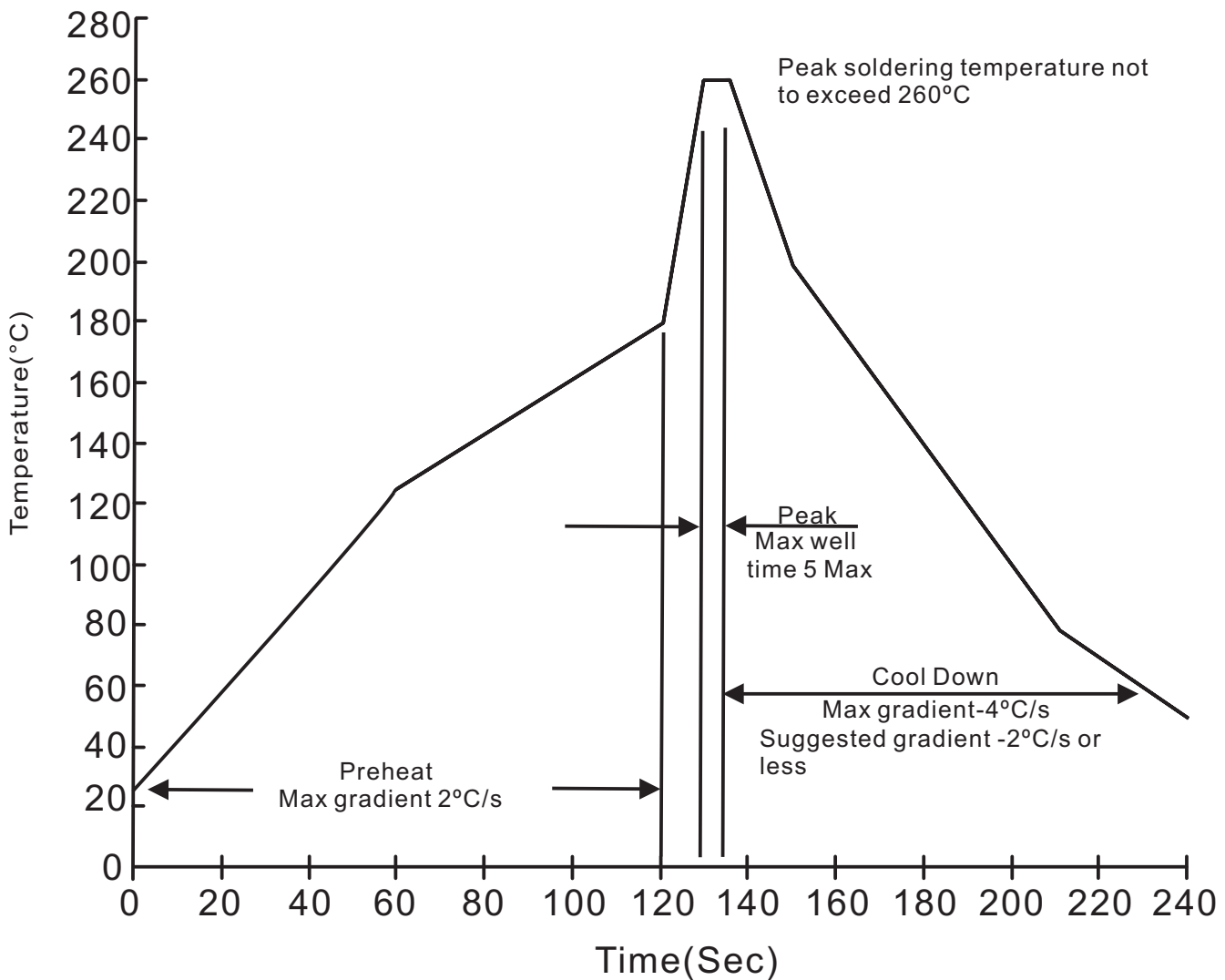

P6KE SERIES

High reliability test capabilities

Item Test	Conditions	Reference
1. Solder Resistance	at $260\pm 5^{\circ}\text{C}$ for $10\pm 2\text{sec.}$ immerse body into solder $1/16''\pm 1/32''$	MIL-STD-750D METHOD-2031
2. Solderability	at $245\pm 5^{\circ}\text{C}$ for 5 sec.	MIL-STD-202F METHOD-208
3. Pull Test	1.0kg in axial lead direction for 10 sec.	MIL-STD-750D METHOD-2036
4. Bend Lead	1.0kg weight applied to each lead bending arc $90^{\circ}\pm 5^{\circ}$ for 3 times.	MIL-STD-750D METHOD-2036
5. High Temperature Reverse Bias	$V_{BR}=V_{BR} N_{OM} * 80\%$ at $T_J=150^{\circ}\text{C}$ for 168 hrs.	MIL-STD-750D METHOD-1038
6. Pressure Cooker	$15P_{SIG}$ at $T_A=121^{\circ}\text{C}$ for 4 hrs.	JESD22-A102
7. Temperature Cycling	-55°C to $+125^{\circ}\text{C}$ dwelled for 30 min. and transferred for 5min. total 10 cycles.	MIL-STD-750D METHOD-1051
8. Humidity	at $T_A=85^{\circ}\text{C}$, RH=85% for 1000hrs.	MIL-STD-750D METHOD-1021
9. High Temperature Storage Life	at 175°C for 1000 hrs.	MIL-STD-750D METHOD-1031