

CKT NO	PART NO	DIM A
2	170001-0102	8.35
4	170001-0104	12.05
6	170001-0106	17.75
8	170001-0108	23.45 ^{+0.40} _{-0.25}
10	170001-0110	29.15 ^{+0.40} _{-0.25}
12	170001-0112	34.85 ^{+0.40} _{-0.25}

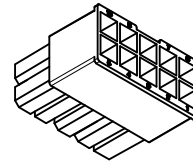

170001-0110

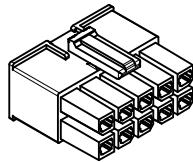
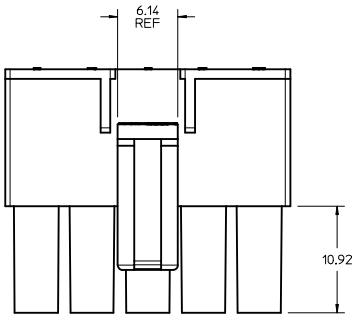
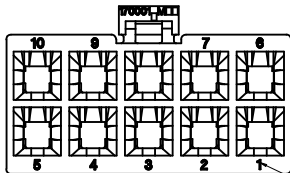
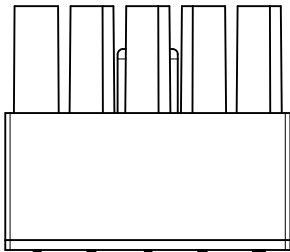
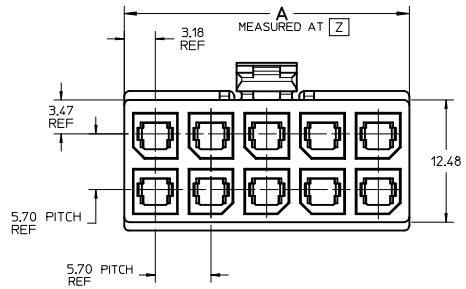
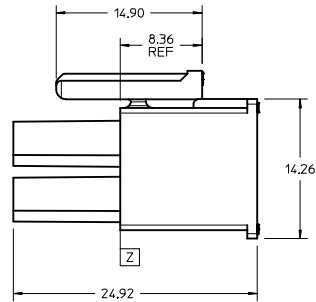

CIRCUIT #

NOTES:

1. MATERIAL:
HOUSING: NYLON, UL94V-2, GLOW WIRE CAPABLE PER IEC-60335-1 5TH EDITION, COLOR: BLACK.
2. FINISH: NOT APPLICABLE.
3. PRODUCT SPECIFICATION PS-76823-100.
4. PACKAGING BULK PACK PER PK-170001-001.
5. PART MATES WITH MOLEX SERIES NUMBER 76825, 172064, 76829 AND 172065.
6. PART IS FOR USE WITH MOLEX FEMALE TERMINALS 76823 OR 172063 SERIES.
7. APPLICATION SPECIFICATION: AS-76823-100.
8. PARTS CONFORM TO CLASS 'B' REQUIREMENTS OF COSMETIC SPECIFICATION PS-45499-002 WITH THE EXCEPTION OF DISCOLORATION MEETS CLASS 'C' REQUIREMENTS.

REVISE RIBS IEC NO: UCP2015-2016 2015/01/09 DRAWN: BELL 2015/01/09 CHKD: BELL 2015/03/10 APPR: SMITH	QUALITY SYMBOLS ∇=0 ∇=0 ∇=0	GENERAL TOLERANCES (UNLESS SPECIFIED): mm INCH		DIMENSION STYLE MM ONLY	SCALE 4:1	DESIGN UNITS METRIC	THIRD ANGLE PROJECTION		
		4 PLACES ±--- ±---	3 PLACES ±--- ±---	2 PLACES ±0.25 ±---	1 PLACE ±--- ±---	0 PLACE ± ±	DRAWN BY MKARADIMAS	DATE 2010/11/23	TITLE MEGA-FIT RECEPTACLE HOUSING 2-12 CKT GLOW WIRE
		ANGULAR ±1/2°		DRAFT WHERE APPLICABLE MUST REMAIN WITHIN DIMENSIONS		APPROVED BY APATEL	DATE 2012/06/13	MATERIAL NO. SEE CHART	DOCUMENT NO. SD-170001-0100
		SIZE D		THIS DRAWING CONTAINS INFORMATION THAT IS PROPRIETARY TO MOLEX INCORPORATED AND SHOULD NOT BE USED WITHOUT WRITTEN PERMISSION					

20 19 18 17 16 15 14 13 12 11 10 9 8 7 6 5 4 3 2 1

2 CKTS

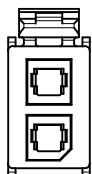

4 CKT

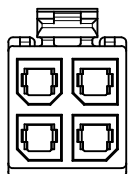

6 CKT

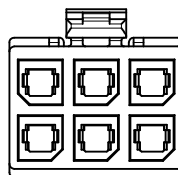

8 CKT

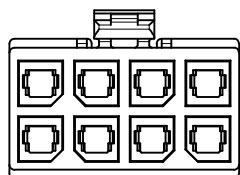

10 CKTS

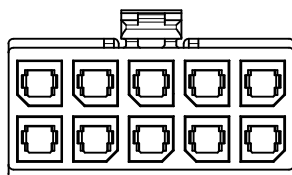

12 CKTS

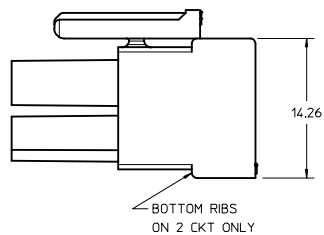
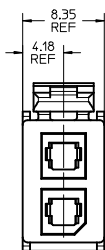
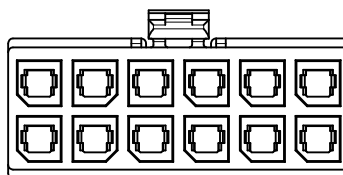

BOTTOM RIBS
ON 2 CKT ONLY

170001-0102

SEE SHT 1 IEC NO: UCP2015-2016 DRAWN: BELL 2015/01/09 CHECKED: BELL 2015/01/09 APPR: FSW TH 2015/03/10 REV DESCRIPTION	QUALITY SYMBOLS	GENERAL TOLERANCES (UNLESS SPECIFIED)	DIMENSION STYLE	SCALE	DESIGN UNITS	THIRD ANGLE PROJECTION
	▽=0	4 PLACES ± mm ± INCH	MM ONLY	4:1	METRIC	☉
	▽=0	3 PLACES ± 0.25				
	▽=0	2 PLACES ±				
		ANGULAR ±1/2°				
		DRAFT WHERE APPLICABLE MUST REMAIN WITHIN DIMENSIONS				
			MATERIAL NO.	APPROVED BY	DATE	TITLE
			SEE CHART	APATEL	2012/06/13	MEGA-FIT RECEPTACLE HOUSING 2-12 CKT GLOW WIRE
			DOCUMENT NO.			
			SD-170001-0100			
						SHEET NO. 2 OF 2
						THIS DRAWING CONTAINS INFORMATION THAT IS PROPRIETARY TO MOLEX INCORPORATED AND SHOULD NOT BE USED WITHOUT WRITTEN PERMISSION

19 18 17 16 15 14 13 12 11 10 9 8 7 6 5 4 3 2 1

CKT NO	PART NO	DIM A
2	171692-0102	8.35
4	171692-0104	12.05
6	171692-0106	17.75
8	171692-0108	23.45 +0.40
10	171692-0110	29.15 +0.40
12	171692-0112	34.85 +0.40

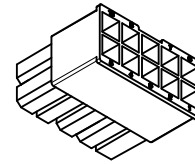
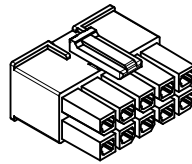
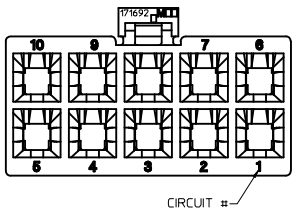
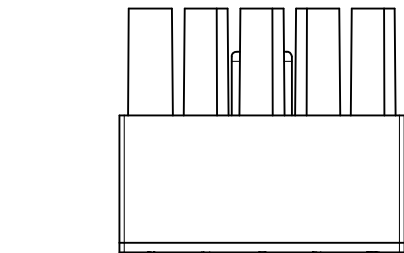
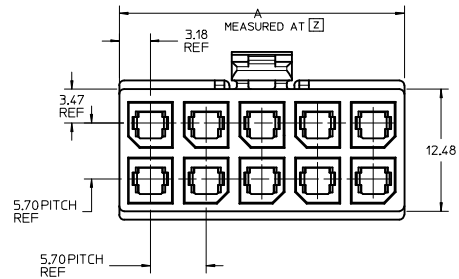
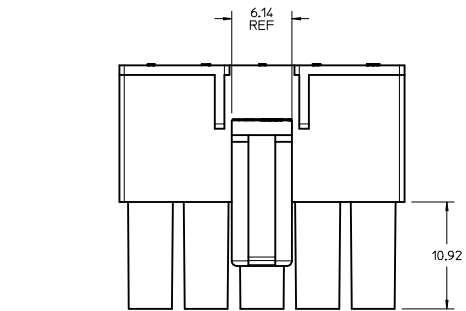

171692-0110

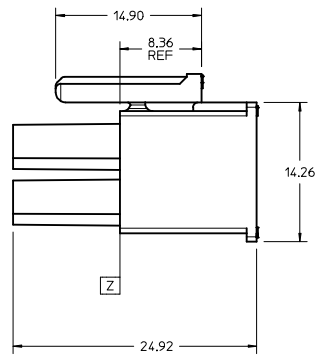

NOTES:

- MATERIAL:
HOUSING: PBT, UL 94V-0, COLOR: BLACK.
- FINISH: NOT APPLICABLE.
- PRODUCT SPECIFICATION: PS-76823-100.
- PACKAGING: BULK PACK PER PK-170001-001
- PART MATES WITH MOLEX SERIES NUMBERS 76825, 76829, 172064, AND 172065.
- PART IS FOR USE WITH MOLEX FEMALE TERMINAL 76823 OR 172063 SERIES.
- APPLICATION SPECIFICATION: AS-76823-100.
- PARTS CONFORM TO CLASS B REQUIREMENTS OF COSMETIC SPECIFICATION PS-45499-002 WITH THE EXCEPTION OF DISCOLORATION MEETS CLASS "C" REQUIREMENTS.

REVISE RIBS IEC NO: UCP2015-2016 2015/01/09 DRAWN: BELL 2015/01/09 CHKD: BELL 2015/03/10 APPR: SMITH 2015/03/10 REV DESCRIPTION	QUALITY SYMBOLS	GENERAL TOLERANCES (UNLESS SPECIFIED)	DIMENSION STYLE	SCALE	DESIGN UNITS	THIRD ANGLE PROJECTION
	▽=0	4 PLACES ±--- ±---	MM ONLY	4:1	METRIC	☉
	▽=0	3 PLACES ±--- ±---				
	▽=0	2 PLACES ±0.25 ±---				
		1 PLACE ±--- ±---				
		0 PLACE ±--- ±---				
		ANGULAR ±1/2°				
		DRAFT WHERE APPLICABLE MUST REMAIN WITHIN DIMENSIONS				
			DRAWN BY	DATE	TITLE	
			CHKD BY	DATE		
			APPR BY	DATE		
			MATERIAL NO.	DOCUMENT NO.		
			SIZE			

MEGA-FIT RECEPTACLE HOUSING 2-12 CKT

molex

SD-171692-0100 SHEET NO. 1 OF 2

THIS DRAWING CONTAINS INFORMATION THAT IS PROPRIETARY TO MOLEX INCORPORATED AND SHOULD NOT BE USED WITHOUT WRITTEN PERMISSION

20 19 18 17 16 15 14 13 12 11 10 9 8 7 6 5 4 3 2 1

2 CKTS

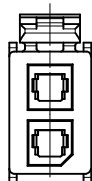

4 CKT

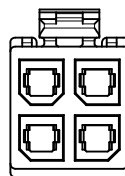

6 CKT

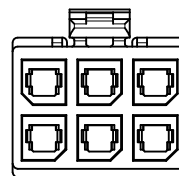

8 CKT

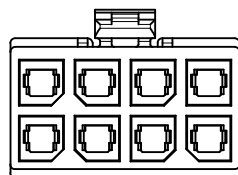

10 CKTS

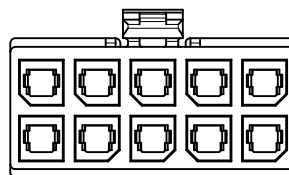

12 CKTS

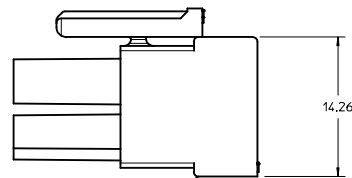
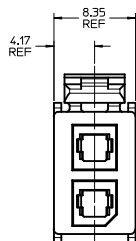
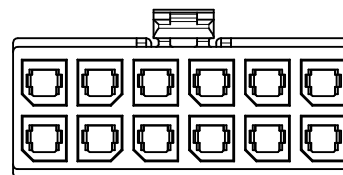

BOTTOM RIB ON
2 CKT ONLY

171692-0102

SEE SHT 1 IEC NO: UCP2015-2016 DRAWN: J.BELL 2015/01/09 CHECKED: J.BELL 2015/01/09 APPROVED: F.S.M.T.H. 2015/03/10	QUALITY SYMBOLS	GENERAL TOLERANCES (UNLESS SPECIFIED)	DIMENSION STYLE	SCALE	DESIGN UNITS	THIRD ANGLE PROJECTION	
	∇=0 ∇=0 ∇=0	mm INCH 4 PLACES ± --- ± --- 3 PLACES ± --- ± --- 2 PLACES ± 0.25 ± --- 1 PLACE ± --- ± --- 0 PLACE ± --- ± ---	MM ONLY	4:1	METRIC	DRAWN BY: MKARADIMAS DATE: 2012/08/01 CHECKED BY: A. PATEL DATE: 2012/08/17 APPROVED BY: APATEL	TITLE: MEGA-FIT RECEPTACLE HOUSING 2-12 CKT MATERIAL NO. SEE CHART DOCUMENT NO. SD-171692-0100
	DRAFT WHERE APPLICABLE MUST REMAIN WITHIN DIMENSIONS	ANGULAR ±1/2° SIZE D	THIS DRAWING CONTAINS INFORMATION THAT IS PROPRIETARY TO MOLEX INCORPORATED AND SHOULD NOT BE USED WITHOUT WRITTEN PERMISSION	SHEET NO. 2 OF 2			

19 18 17 16 15 14 13 12 11 10 9 8 7 6 5 4 3 2 1