

## Ultra-Low On-Resistance, 6A Dual Load Switch with Soft Start

### Features

- **16mW(Typical) On-resistance per Channel**
- **6A Continuous Current**
- **Soft Start Time Programmable by External Capacitor**
- **Wide Input Voltage Range (VIN): 0.8V to 5.5V**
- **Supply Voltage Range (VBIAS): 3V to 5.5V**
- **Output Discharge when Switch Disabled**
- **Reverse Current Blocking when Switch Disabled**
- **Over-Temperature Protection**
- **Enable Input**
- **Lead Free and Green Devices Available (RoHS Compliant)**

### General Description

The APL3523A is an ultra-low on-resistance, dual power-distribution switch with external soft start control. It integrates two N-channel MOSFETs that can deliver 6A continuous load current each.

The device integrates over-temperature protection. The over temperature protection function shuts down the N-channel MOSFET power switch when the junction temperature rises beyond 160°C and will automatically turns on the power switch when the temperature drops by 40°C. The device is available in lead free TDFN2x3-14 packages.

### Applications

- **Notebook**
- **AIO PC**

### Pin Configurations

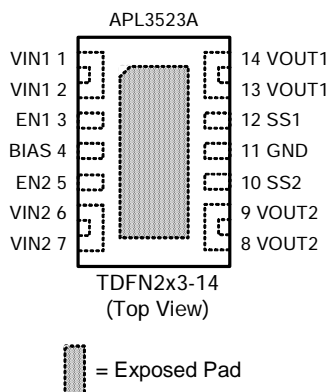

### Simplified Application Circuit

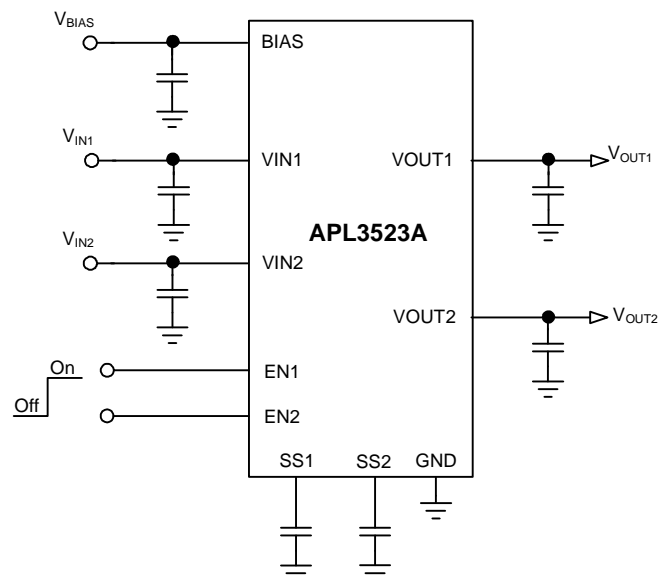

ANPEC reserves the right to make changes to improve reliability or manufacturability without notice, and advise customers to obtain the latest version of relevant information to verify before placing orders.

## Ordering and Marking Information

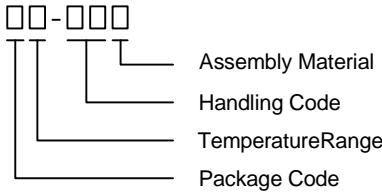
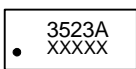
APL3523A		Package Code QB : TDFN2x3-14 Operating Ambient Temperature Range I : -40 to 85°C Handling Code TR : Tape & Reel Assembly Material G : Halogen and Lead Free Device
APL3523A QB:		XXXXX-Date Code

Note : ANPEC lead-free products contain molding compounds/die attach materials and 100% matte tin plate termination finish; which are fully compliant with RoHS. ANPEC lead-free products meet or exceed the lead-free requirements of IPC/JEDEC J-STD-020D for MSL classification at lead-free peak reflow temperature. ANPEC defines "Green" to mean lead-free (RoHS compliant) and halogen free (Br or Cl does not exceed 900ppm by weight in homogeneous material and total of Br and Cl does not exceed 1500ppm by weight).

## Absolute Maximum Ratings (Note 1)

Symbol	Parameter	Rating	Unit
$V_{BIAS}$	BIAS to GND Voltage	-0.3 ~ 6	V
$V_{IN1}, V_{IN2}$	VIN1, VIN2 to GND Voltage	-0.3 ~ 6	V
$V_{OUT1}, V_{OUT2}$	VOUT1, VOUT2 to GND Voltage	-0.3 ~ 6	V
$V_{EN1}, V_{EN2}$	EN1, EN2 to GND Voltage	-0.3 ~ 6	V
$T_J$	Maximum Junction Temperature	-40 ~ 150	°C
$T_{STG}$	Storage Temperature	-65 ~ 150	°C
$T_{SDR}$	Maximum Lead Soldering Temperature (10 Seconds)	260	°C

Note1: Stresses beyond those listed under "absolute maximum ratings" may cause permanent damage to the device. These are stress ratings only and functional operation of the device at these or any other conditions beyond those indicated under "recommended operating conditions" is not implied. Exposure to absolute maximum rating conditions for extended periods may affect device reliability.

## Thermal Characteristics

Symbol	Parameter	Typical Value	Unit
$\theta_{JA}$	Junction-to-Ambient Resistance in Free Air <small>(Note 2)</small>	80	°C/W
$\theta_{JC}$	Junction-to-Case Resistance in Free Air	15	°C/W

Note 2:  $\theta_{JA}$  is measured with the component mounted on a high effective thermal conductivity test board in free air. The exposed pad of TDFN2x3-14 is soldered directly on the PCB.

## Recommended Operating Conditions (Note 3)

Symbol	Parameter	Range	Unit
$V_{BIAS}$	BIAS Input Voltage ( $V_{BIAS} \geq V_{IN}$ )	3.0 ~ 5.5	V
$V_{IN}$	VIN Input Voltage	0.8 ~ 5.5	V
$I_{OUT}$	VOUT Output Current (Single Channel)	0 ~ 6	A
	Maximum Pulsed Switch Current, Pulse<300 $\mu$ s, 1% Duty Cycle (Single Channel)	8	
$P_D$	Maximum Power Dissipation, $T_A=50^\circ\text{C}$ <small>(Note4)</small>	0.94	W
$V_{IH}$	EN/ENB Logic High Input Voltage	0.8 ~ 5.5	V
$V_L$	EN/ENB Logic Low Input Voltage	0 ~ 0.4	V
$T_A$	Ambient Temperature	-40 ~ 85	$^\circ\text{C}$
$T_J$	Junction Temperature	-40 ~ 125	$^\circ\text{C}$

Note 3 : Refer to the typical application circuit.

Note 4 : Refer to the thermal consideration on page 15.

## Electrical Characteristics

Unless otherwise specified, these specifications apply over  $V_{IN1} = V_{IN2} = 0.8\text{V} \sim 5.5\text{V}$ ,  $V_{EN1} = V_{EN2} = V_{BIAS} = 5\text{V}$  and  $T_A = -40 \sim 85^\circ\text{C}$ . Typical values are at  $T_A = 25^\circ\text{C}$ .

Symbol	Parameter	Test Conditions	APL3523A			Unit	
			Min.	Typ.	Max.		
<b>SUPPLY CURRENT</b>							
$I_{BIAS}$	BIAS Supply Current (both channels)	No load, $V_{BIAS}=5\text{V} = V_{EN1,2}=5\text{V}$	-	60	90	$\mu\text{A}$	
	BIAS Supply Current (single channel)	No load, $V_{BIAS}=5\text{V}$ , $V_{EN1}=5\text{V}$ , $V_{EN2}=0\text{V}$	-	50	-	$\mu\text{A}$	
$I_{SD}$	BIAS Supply Current at Shutdown	No load, $V_{BIAS}=5\text{V}$ , $V_{EN1,2}=0\text{V}$	-	-	2	$\mu\text{A}$	
$I_{OFF}$	VIN Off-State Supply Current (per channel)	No load, $V_{BIAS}=5\text{V}$ , $V_{EN1,2}=0\text{V}$ , $V_{IN1,2}=5\text{V}$	-	0.1	8	$\mu\text{A}$	
		No load, $V_{BIAS}=5\text{V}$ , $V_{EN1,2}=0\text{V}$ , $V_{IN1,2}=3.3\text{V}$	-	0.1	3	$\mu\text{A}$	
		No load, $V_{BIAS}=5\text{V}$ , $V_{EN1,2}=0\text{V}$ , $V_{IN1,2}=1.8\text{V}$	-	0.1	2	$\mu\text{A}$	
		No load, $V_{BIAS}=5\text{V}$ , $V_{EN1,2}=0\text{V}$ , $V_{IN1,2}=0.8\text{V}$	-	0.1	1	$\mu\text{A}$	
	Reverse Leakage Current (per channel)	$V_{EN1,2}=0\text{V}$ , $V_{IN1,2}=0\text{V}$	-	0.1	16	$\mu\text{A}$	
<b>UNDER-VOLTAGE LOCKOUT (UVLO)</b>							
	Rising BIAS UVLO Threshold	$V_{BIAS}$ rising	1.9	2.4	2.9	V	
	BIAS UVLO Hysteresis		-	0.1	-	V	
<b>POWER SWITCH</b>							
$R_{DS(ON)}$	Power Switch On Resistance	$I_{OUT}=200\text{mA}$ , $T_J=25^\circ\text{C}$	Channel 1	-	16	18	$\text{m}\Omega$
		$I_{OUT}=200\text{mA}$ , $T_J=-40 \sim 125^\circ\text{C}$		-	-	24	$\text{m}\Omega$
		$I_{OUT}=200\text{mA}$ , $T_J=25^\circ\text{C}$	Channel 2	-	16	18	$\text{m}\Omega$
		$I_{OUT}=200\text{mA}$ , $T_J=-40 \sim 125^\circ\text{C}$		-	-	24	$\text{m}\Omega$
	VOUT Discharge Resistance	$V_{EN1,2}=0\text{V}$ , VOUT1 or VOUT2 force 1V	-	150	180	$\Omega$	

## Electrical Characteristics

Unless otherwise specified, these specifications apply over  $V_{IN1} = V_{IN2} = 0.8V \sim 5.5V$ ,  $V_{EN1} = V_{EN2} = V_{BIAS} = 5V$  and  $T_A = -40 \sim 85^\circ C$ . Typical values are at  $T_A = 25^\circ C$ .

Symbol	Parameter	Test Conditions	APL3523A			Unit
			Min.	Typ.	Max.	
<b>SOFT-START CONTROL PIN</b>						
	SS Discharge Current	$V_{SS1,2}=6V, V_{EN1,2}=0V, EN2=low$ , measured at SS1 or SS2	-	560	-	$\mu A$
<b>EN INPUT PIN</b>						
	Input Logic High		1.2	-	-	V
	Input Logic Low		-	-	0.4	V
	Input Current		-	-	1	$\mu A$
<b>OVERT-TEMPERATURE PROTECTION (OTP)</b>						
	Over-Temperature Threshold	$T_J$ rising	-	160	-	$^\circ C$
	Over-Temperature Hysteresis		-	40	-	$^\circ C$

## Timing Chart

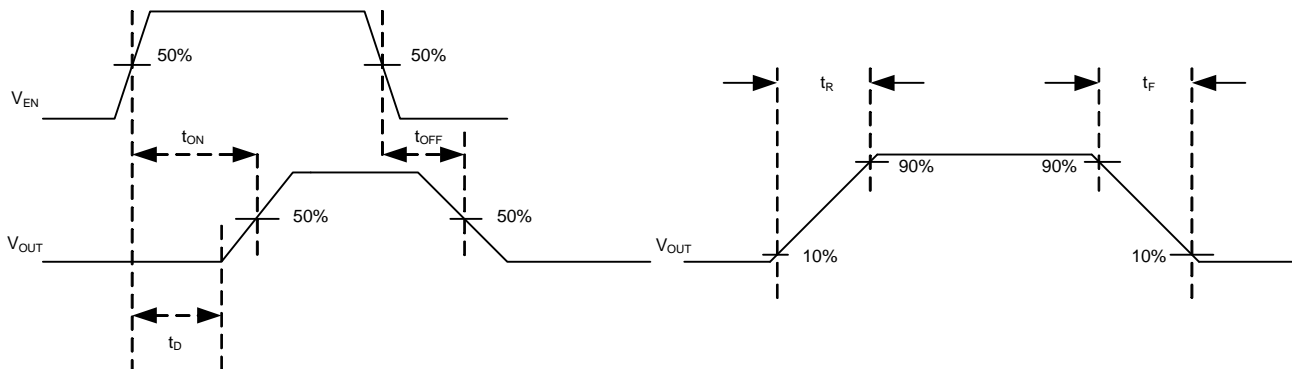
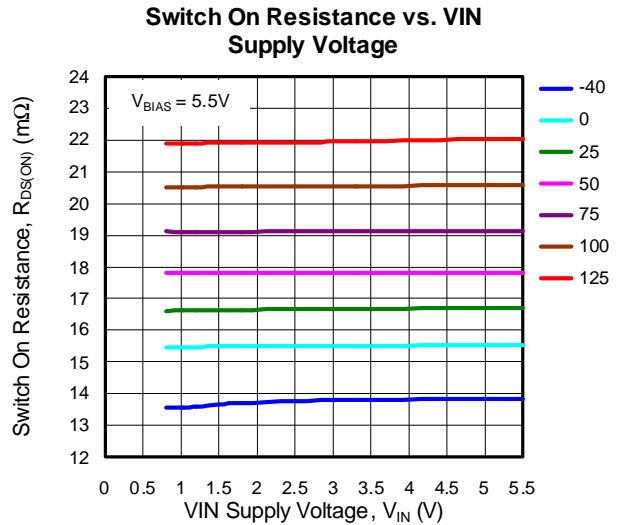
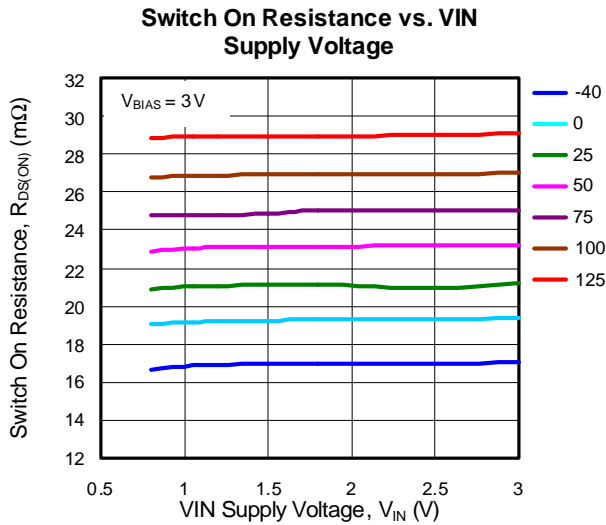
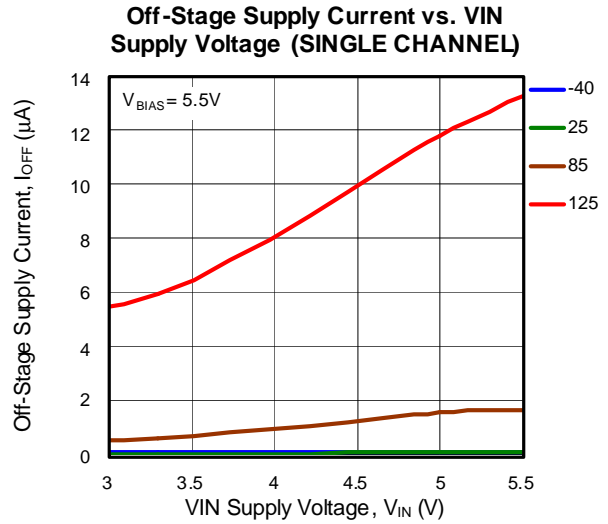
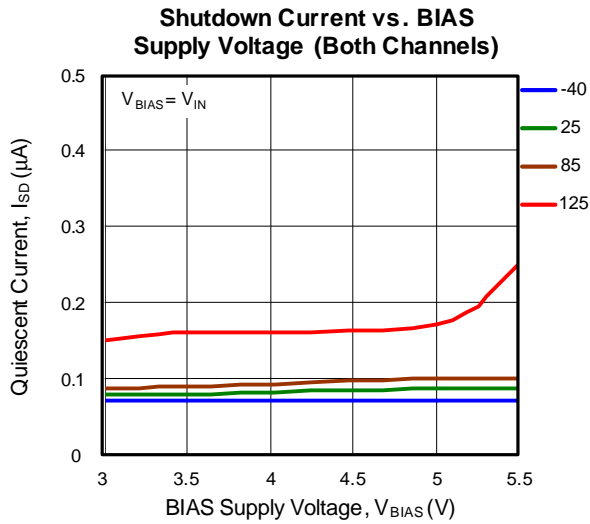
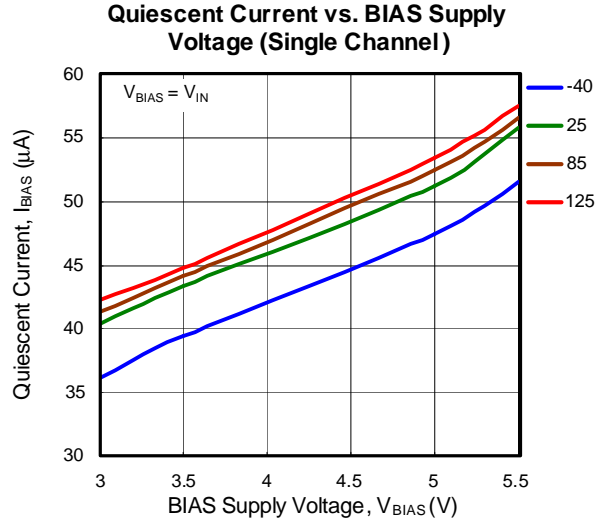
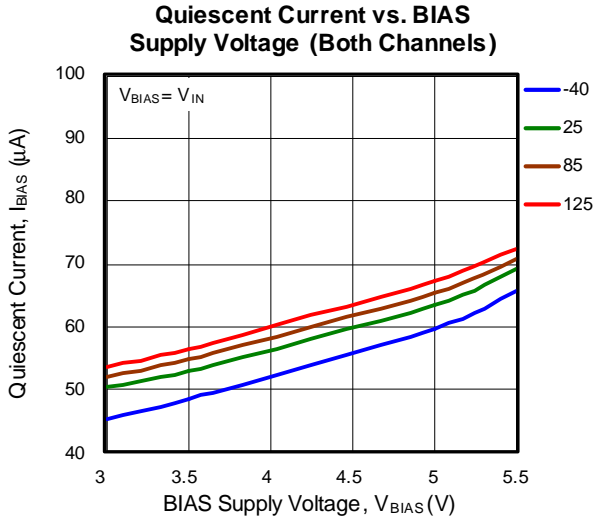
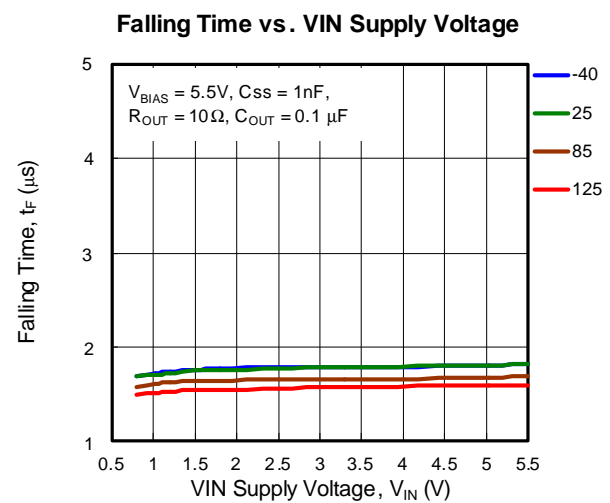
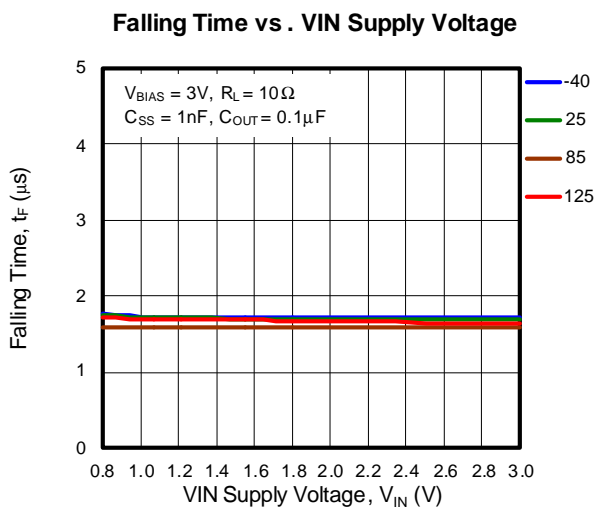
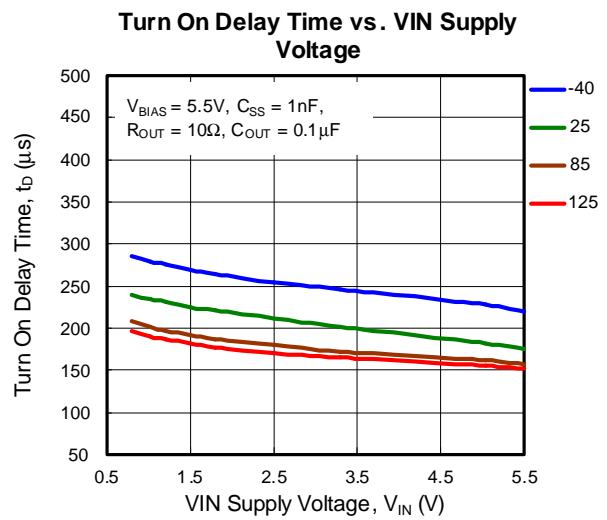
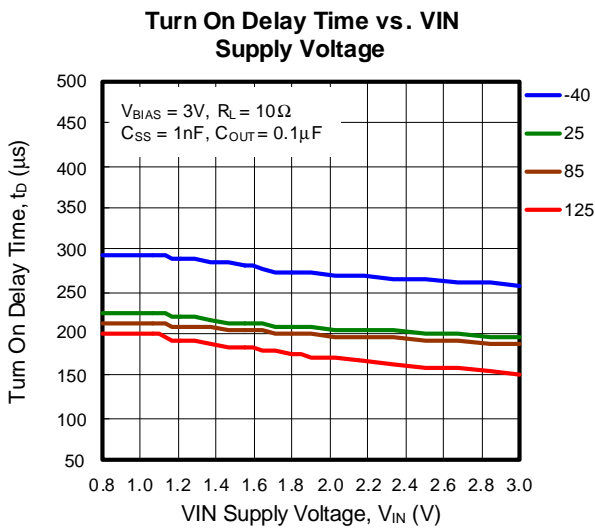
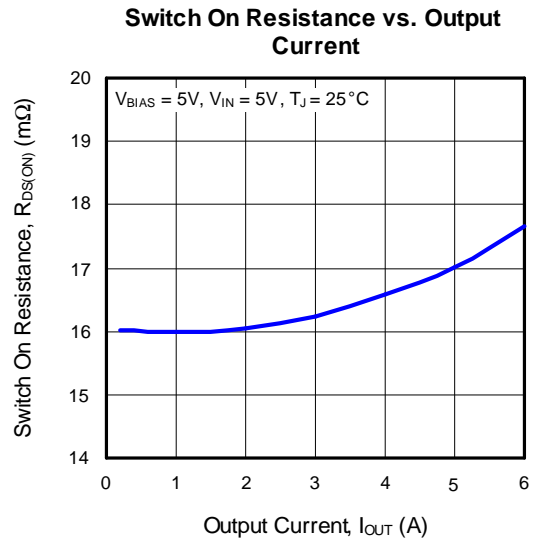
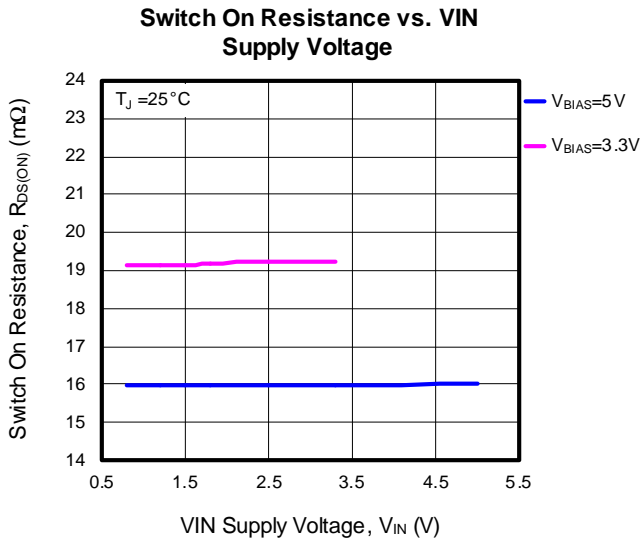

Figure 1.  $t_{ON}/t_{OFF}, t_R/t_F$  Waveforms

Typical Operating Characteristics



Typical Operating Characteristics



Typical Operating Characteristics

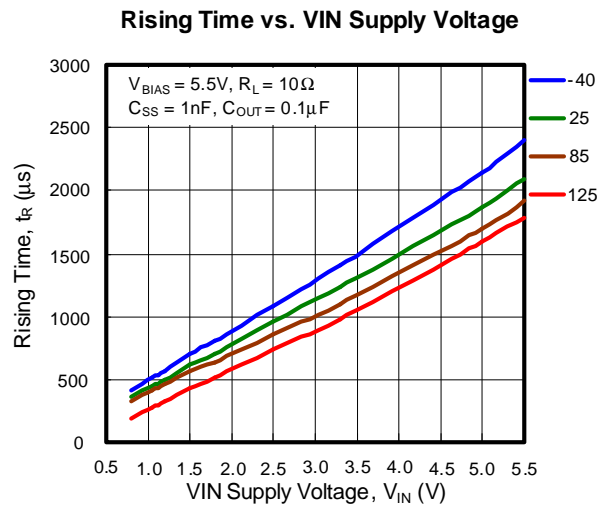
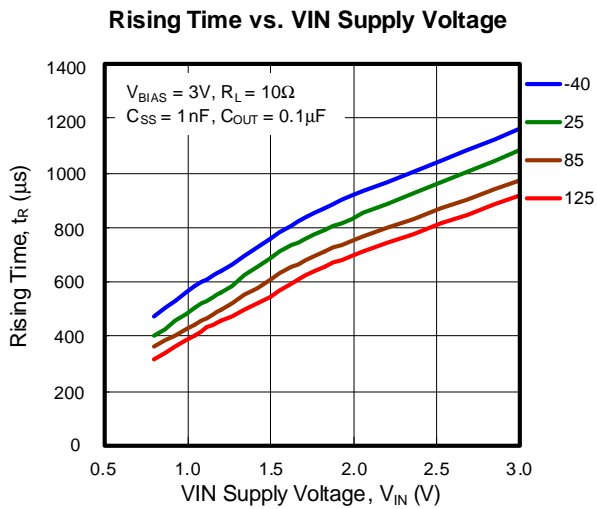
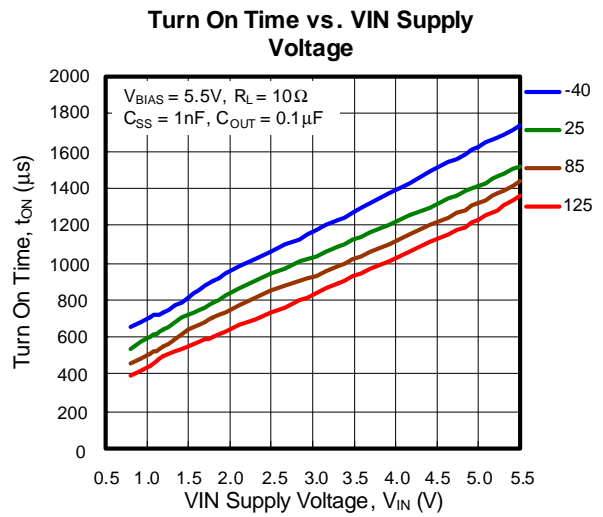
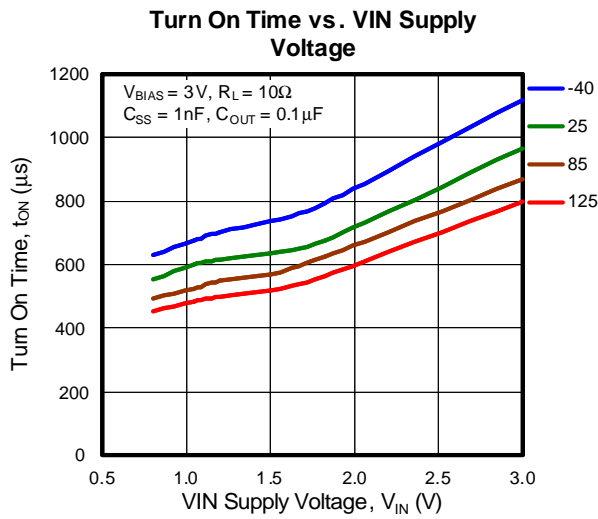
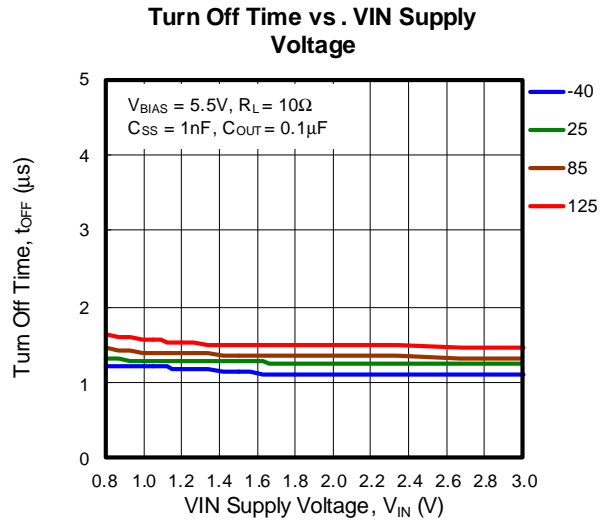
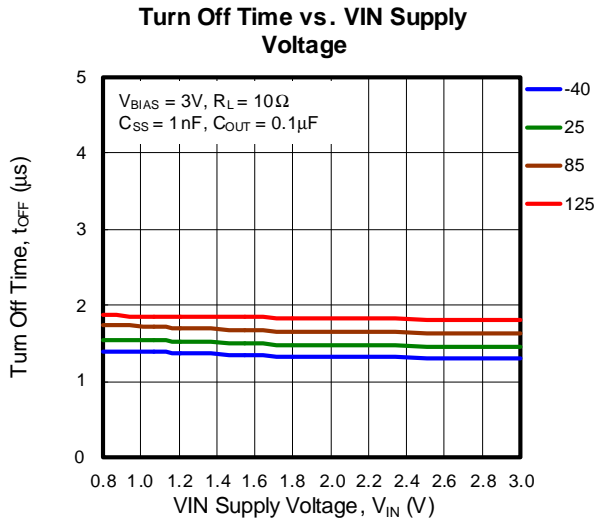

### Typical Operating Characteristics

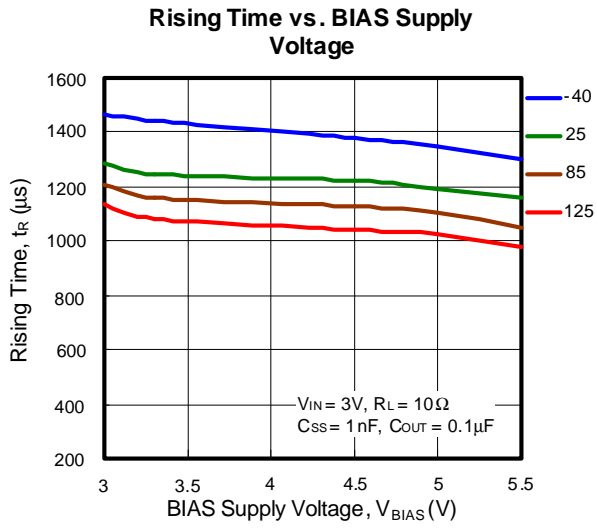



### Operating Waveforms

Refer to the typical application circuit.  $T_A = 25^\circ\text{C}$  unless otherwise specified.

Enable

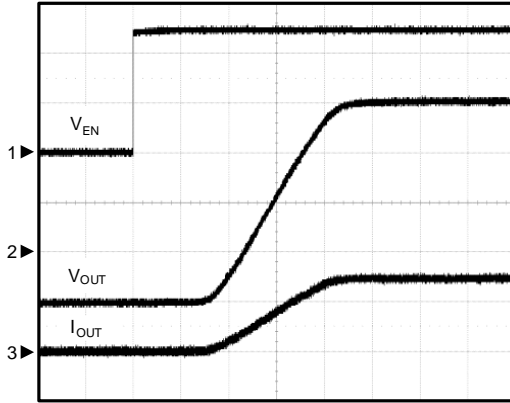

$V_{BIAS}=5\text{V}, V_{IN}=0.8\text{V}$   
 $C_{OUT}=0.1\mu\text{F}, C_{SS}=1\text{nF}, R_L=10\Omega$   
 CH1:  $V_{EN}$ , 2V/Div, DC  
 CH2:  $V_{OUT}$ , 200mV/Div, DC  
 CH3:  $I_{OUT}$ , 50mA/Div, DC  
 TIME: 200 $\mu\text{s}$ /Div

Shutdown

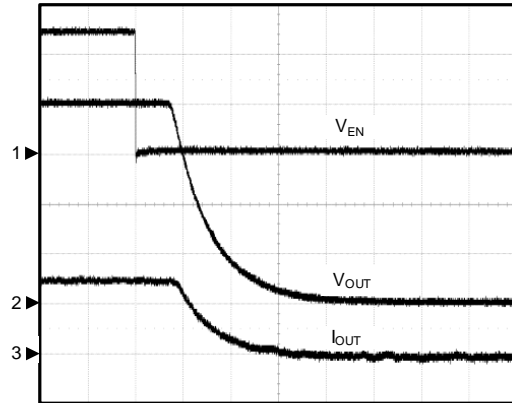

$V_{BIAS}=5\text{V}, V_{IN}=0.8\text{V}$   
 $C_{OUT}=0.1\mu\text{F}, C_{SS}=1\text{nF}, R_L=10\Omega$   
 CH1:  $V_{EN}$ , 2V/Div, DC  
 CH2:  $V_{OUT}$ , 200mV/Div, DC  
 CH3:  $I_{OUT}$ , 50mA/Div, DC  
 TIME: 1 $\mu\text{s}$ /Div

Enable

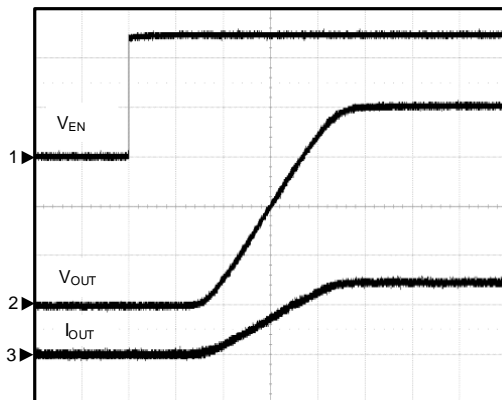

$V_{BIAS}=3\text{V}, V_{IN}=0.8\text{V}$   
 $C_{OUT}=0.1\mu\text{F}, C_{SS}=1\text{nF}, R_L=10\Omega$   
 CH1:  $V_{EN}$ , 2V/Div, DC  
 CH2:  $V_{OUT}$ , 200mV/Div, DC  
 CH3:  $I_{OUT}$ , 50mA/Div, DC  
 TIME: 200 $\mu\text{s}$ /Div

Shutdown

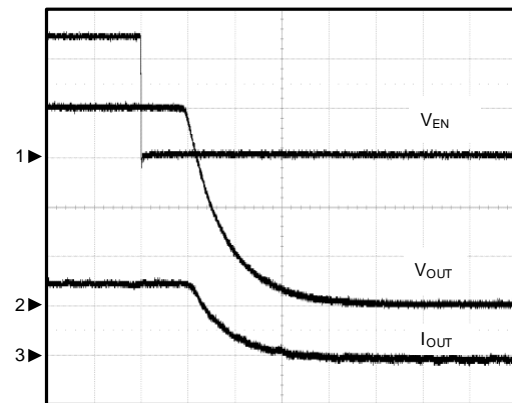

$V_{BIAS}=3\text{V}, V_{IN}=0.8\text{V}$   
 $C_{OUT}=0.1\mu\text{F}, C_{SS}=1\text{nF}, R_L=10\Omega$   
 CH1:  $V_{EN}$ , 2V/Div, DC  
 CH2:  $V_{OUT}$ , 200mV/Div, DC  
 CH3:  $I_{OUT}$ , 50mA/Div, DC  
 TIME: 1 $\mu\text{s}$ /Div

### Operating Waveforms

Refer to the typical application circuit.  $T_A = 25^\circ\text{C}$  unless otherwise specified.

Enable

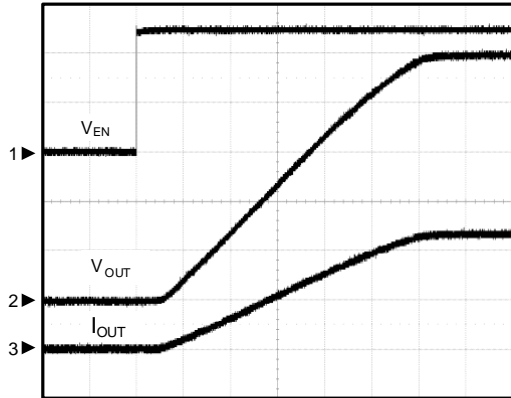

$V_{BIAS}=5V, V_{IN}=5V$   
 $C_{OUT}=0.1\mu F, C_{SS}=1nF, R_L=10\Omega$   
 CH1:  $V_{EN}, 2V/Div, DC$   
 CH2:  $V_{OUT}, 1V/Div, DC$   
 CH3:  $I_{OUT}, 200mA/Div, DC$   
 TIME:  $500\mu s/Div$

Shutdown

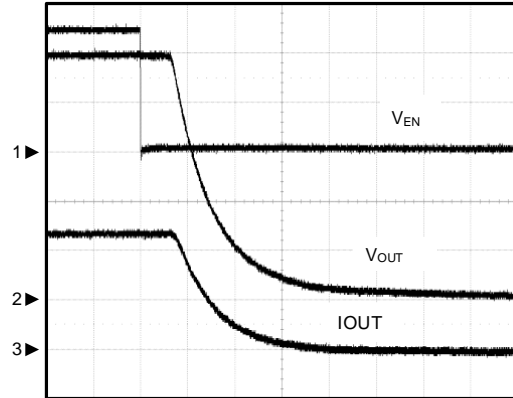

$V_{BIAS}=5V, V_{IN}=5V$   
 $C_{OUT}=0.1\mu F, C_{SS}=1nF, R_L=10\Omega$   
 CH1:  $V_{EN}, 2V/Div, DC$   
 CH2:  $V_{OUT}, 1V/Div, DC$   
 CH3:  $I_{OUT}, 200mA/Div, DC$

**Pin Description**

PIN		FUNCTION
NO.	NAME	
1	VIN1	Power supply Input of switch 1. Connect this pin to an external DC supply.
2	VIN1	
3	EN1	Enable input of switch 1. Logic high turns on switch 1. The EN1 pin cannot be left floating.
4	BIAS	Bias voltage input pin for internal control circuitry.
5	EN2	Enable input of switch 2. Logic high turns on switch 2. The EN2 pin cannot be left floating.
6	VIN2	Power supply Input of switch 2. Connect this pin to an external DC supply.
7	VIN2	
8	VOUT2	Switch 2 output.
9	VOUT2	
10	SS2	Soft start control of switch 2. A capacitor from this pin to ground sets the VOUT2's rise slew rate.
11	GND	Ground pin of the circuitry. All voltage levels are measured with respect to this pin.
12	SS1	Soft start control of switch 1. A capacitor from this pin to ground sets the VOUT1's rise slew rate.
13	VOUT1	Switch 1 output.
14	VOUT1	
Exposed Pad	-	Connect the exposed pad to the system ground plan.

Block Diagram

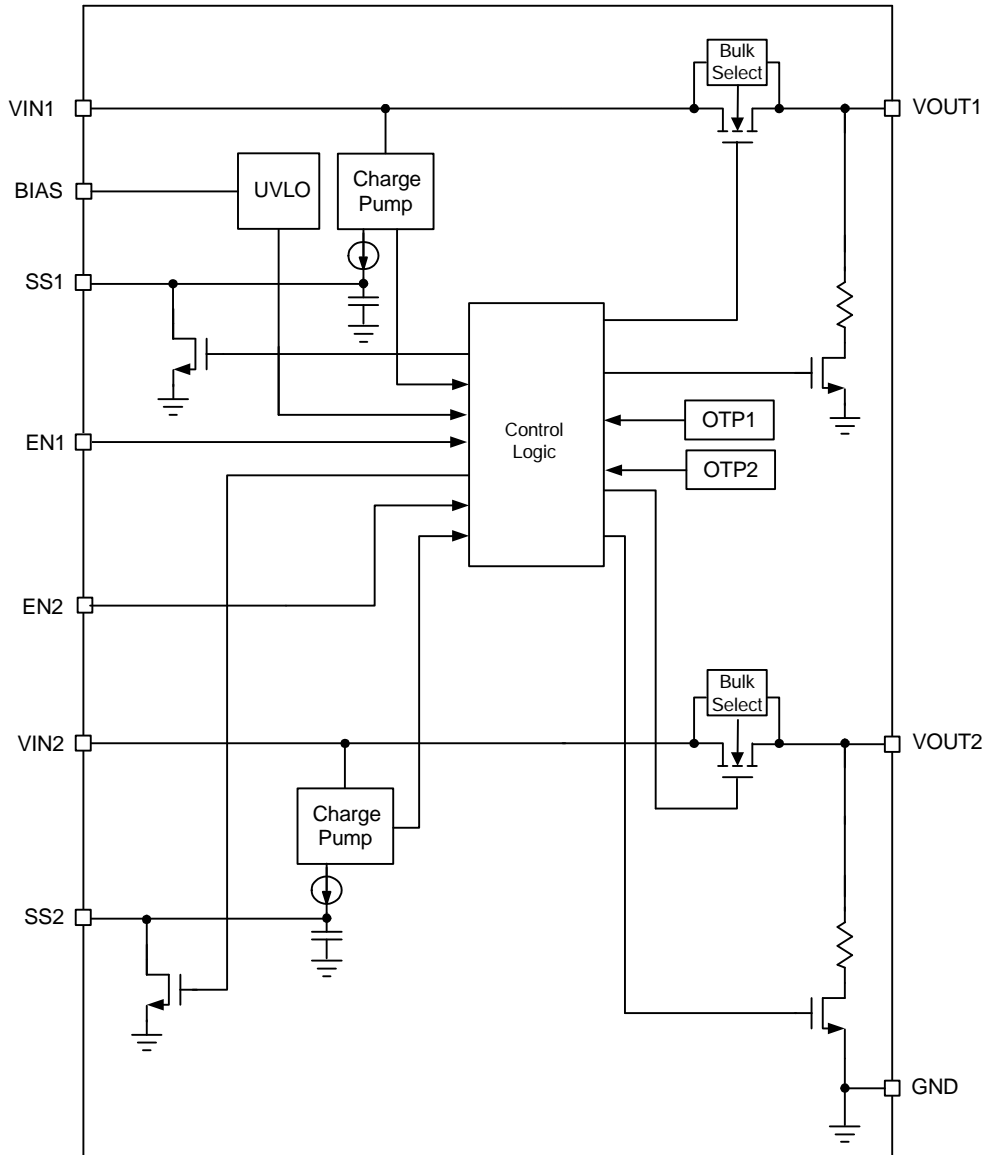

Typical Application Circuit

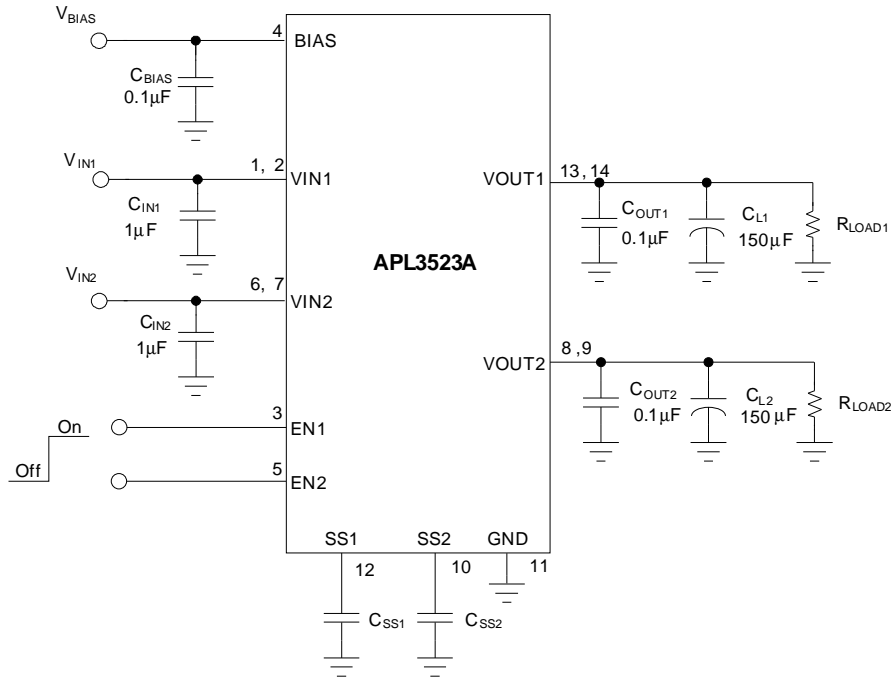

C <sub>SS</sub> (pF)	Soft-Start Time (ms) 10% to 90%, V <sub>BIAS</sub> =5V, C <sub>L</sub> =0.1mF, C <sub>IN</sub> =1mF, R <sub>L</sub> =10W, Typical values are at T <sub>A</sub> =25°C						
	V <sub>IN</sub> =5V	V <sub>IN</sub> =3.3V	V <sub>IN</sub> =1.8V	V <sub>IN</sub> =1.5V	V <sub>IN</sub> =1.2V	V <sub>IN</sub> =1.05V	V <sub>IN</sub> =0.8V
0	112	73	53	49	45	42	38
220	492	322	197	170	146	132	128
330	685	450	270	230	198	180	145
470	911	598	355	307	263	233	188
1000	2030	1280	749	635	538	470	388
2200	4360	2740	1574	1336	1118	1014	797
4700	8780	5540	3218	2696	2289	2037	1624
10000	19060	12011	6862	5700	4806	4301	3410

Note: The table Contains soft-start time values measured on a typical device. The soft-start times shown are only valid for the power-up sequence where V<sub>IN</sub> and V<sub>BIAS</sub> are already in steady state condition, and EN pin is asserted high.

## Function Description

### VIN Under-voltage Lockout (UVLO)

A under-voltage lockout (UVLO) circuit monitors the VBIAS pins voltage to prevent wrong logic controls. The UVLO function initiates a soft-start process after the BIAS supply voltages exceed rising UVLO voltage threshold during powering on.

### Power Switch

The power switch is an N-channel MOSFET with a ultra-low  $R_{DS(ON)}$ . When IC is in shutdown state ( $V_{EN1,2}=0V$ ), the MOSFET prevents a reverse current flowing from the VOUT back to VIN. When IC is in UVLO state, the internal parasitic diodes connected from VOUT to VIN will be forward biased.

### Soft-start

The APL3523A Provides an adjustable soft-start circuitry to control rise rate of the output voltage and limit the current surge during start-up. The soft-start time is set with a capacitor from the SS pin to the ground.

### Enable Control

The APL3523A has a dedicated enable pin (EN). A logic low signal applied to this pin shuts down the output. Following a shutdown, a logic high signal re-enables the output through initiation of a new soft-start cycle.

### Over-Temperature Protection (OTP)

When the junction temperature exceeds 160°C, the internal thermal sense circuit turns off the power FET and allows the device to cool down. When the device's junction temperature cools by 40°C, the internal thermal sense circuit will enable the device, resulting in a pulsed output during continuous thermal protection. Thermal protection is designed to protect the IC in the event of over temperature conditions. For normal operation, the junction temperature cannot exceed  $T_J=+125^{\circ}C$ .

## Application Information

### Power Sequencing

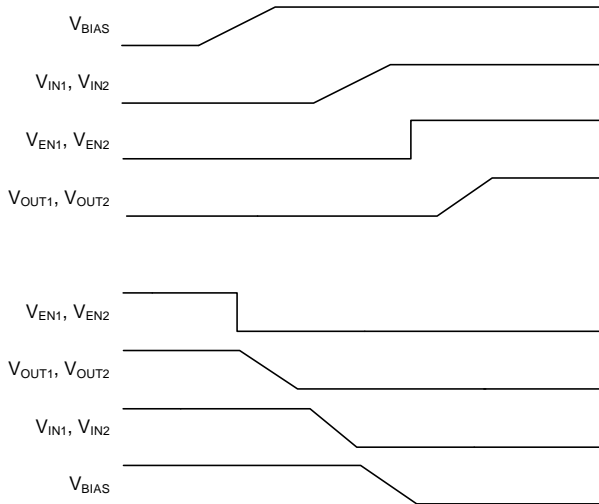

Figure 2. APL3523A Power Sequencing Diagram

The APL3523A has a built-in reverse current blocking circuit to prevent a reverse current flowing through the body diode of power switch from the VOUT back VIN pin when power switch disabled. The reverse current blocking circuit is not active before  $V_{BIAS}$  is ready. When IC is in UVLO state, the internal parasitic diodes of power switch connected from VOUT to VIN will be forward biased. Otherwise, VOUT should not be higher than VBIAS, and VBIAS must be higher than the voltage of any other input pin, the reason is that the internal parasitic diodes connected from VOUT to VBIAS will be forward biased.

### Capacitor Selection

The APL3523A requires proper input capacitors to supply current surge during stepping load transients to prevent the input voltage rail from dropping. Because the parasitic inductor from the voltage sources or other bulk capacitors to the VIN pin limit the slew rate of the surge currents, more parasitic inductance needs more input capacitance.

For normal applications (except OTP or output short circuit has occurred), the recommended input capacitance of VIN is 1 $\mu$ F. Additional input capacitance may be needed on the input to reduce voltage overshoot from exceeding the absolute maximum voltage of the device during load transient conditions. The output capacitance of VOUT is 0.1 $\mu$ F at least. Please place the capacitors near the APL3523A as close as possible.

A bulk output capacitor, placed close to the load, is recommended to support load transient current.

### Soft-Start Capacitor

The soft-start capacitor on SS pin can reduce the inrush current and overshoot of output voltage. The soft-start time is set with a capacitor from the SS pin to the ground.

### Thermal Consideration

The APL3523A maximum power dissipation depends on the differences of the thermal resistance and temperature between junction and ambient air. The power dissipation  $P_D$  across the device is:

$$P_D = (T_J - T_A) / \theta_{JA}$$

where  $(T_J - T_A)$  is the temperature difference between the junction and ambient air.  $\theta_{JA}$  is the thermal resistance between junction and ambient air. Assuming the  $T_A = 25^\circ\text{C}$  and maximum  $T_J = 160^\circ\text{C}$  (typical thermal limit threshold), the maximum power dissipation is calculated as:

$$P_{D(max)} = (160 - 25) / 80 = 1.68(\text{W})$$

For normal operation, do not exceed the maximum operating junction temperature of  $T_J = 125^\circ\text{C}$ . The calculated power dissipation should be less than:

$$P_D = (125 - 25) / 80 = 1.25(\text{W}) \dots \dots \dots T_A = 25^\circ\text{C}$$

$$P_D = (125 - 85) / 80 = 0.5(\text{W}) \dots \dots \dots T_A = 85^\circ\text{C}$$

The power dissipation depends on operating ambient temperature for fixed  $T_J = 125^\circ\text{C}$  and thermal resistance  $\theta_{JA}$ . For APL3523A packages, the Figure 3~4 of derating curves allows the designer to see the effect of rising ambient temperature on the maximum power allowed.

$$P_D = (I_{OUT1}^2 + I_{OUT2}^2) \cdot R_{DS,ON}$$

$$R_{DS,ON} = 0.024\Omega \quad \text{LLLLLLLLL } T_J = 125^\circ\text{C}$$

$$I_{OUT2} = k \cdot I_{OUT1} \quad \text{LLLLLLLLL } k \leq 1$$

or

$$I_{OUT1} = k \cdot I_{OUT2} \quad \text{LLLLLLLLL } k \leq 1$$

$$I_{OUT1,2(MAX)} = 6\text{A}$$

### Application Information

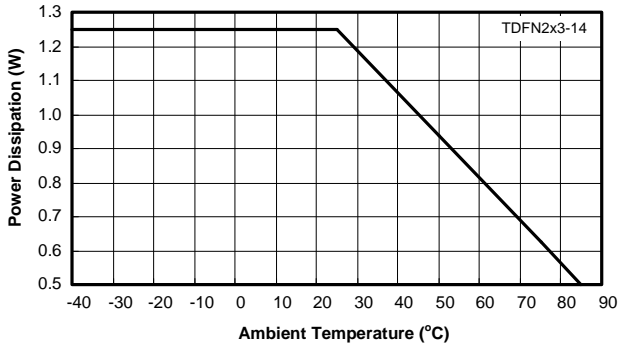

Figure 3. Derating Curves for APL3523A Package

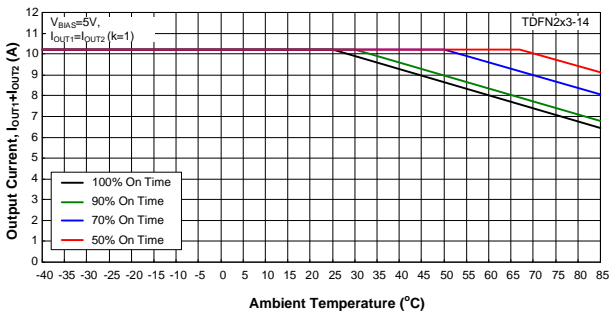
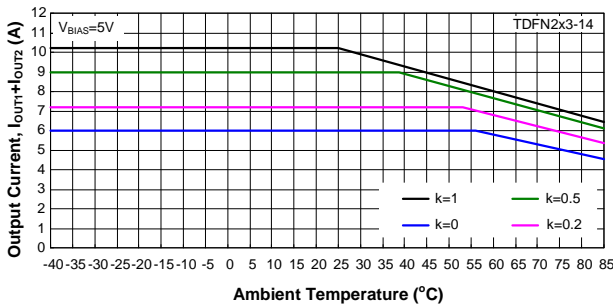

Figure 4. Safe Operating Area for APL3523A Package

### Layout Consideration

The PCB layout should be carefully performed to maximize thermal dissipation and to minimize voltage drop, droop and EMI. The following guidelines must be considered:

1. Please place the input capacitors near the VIN pin as close as possible.
2. Output decoupling capacitors for load must be placed near the load as close as possible for decoupling high frequency ripples.
3. Locate APL3523A and output capacitors near the load to reduce parasitic resistance and inductance for excellent load transient performance.
4. The negative pins of the input and output capacitors and the GND pin must be connected to the ground plane of the load.
5. Keep VIN and VOUT traces as wide and short as possible.

### Recommended Minimum Footprint

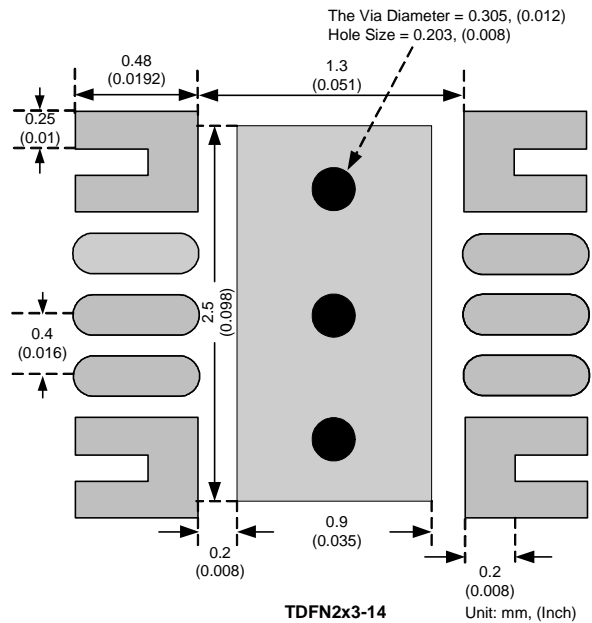



## Package Information

TDFN2x3-14

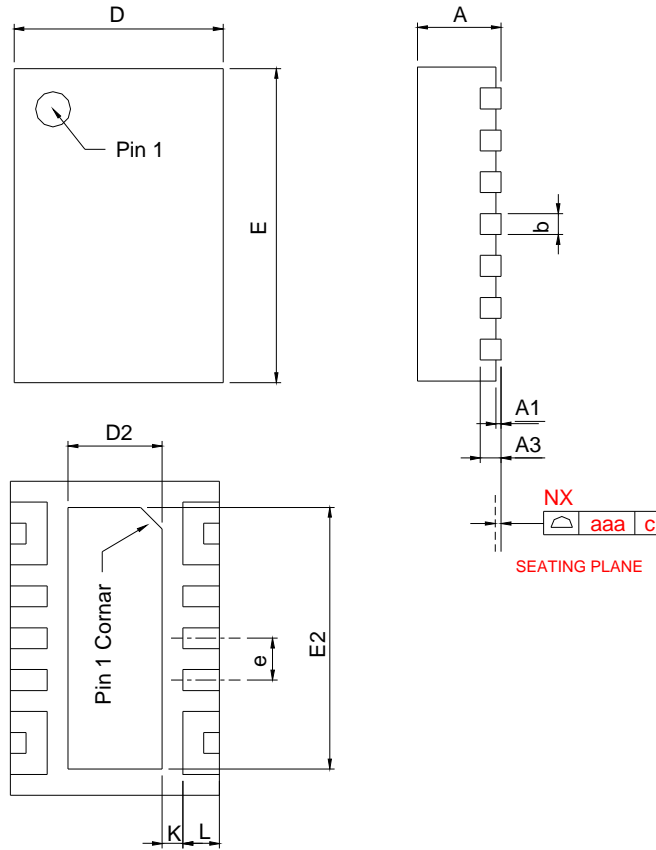

SYMBOL	TDFN2x3-14			
	MILLIMETERS		INCHES	
	MIN.	MAX.	MIN.	MAX.
A	0.70	0.80	0.028	0.031
A1	0.00	0.05	0.000	0.002
A3	0.11 REF		0.004 REF	
b	0.15	0.25	0.006	0.010
D	1.90	2.10	0.075	0.083
D2	0.80	1.00	0.031	0.039
E	2.90	3.10	0.114	0.122
E2	2.40	2.60	0.094	0.102
e	0.40 BSC		0.016 BSC	
L	0.30	0.40	0.012	0.016
K	0.20		0.008	
aaa	0.08		0.003	

Carrier Tape & Reel Dimensions

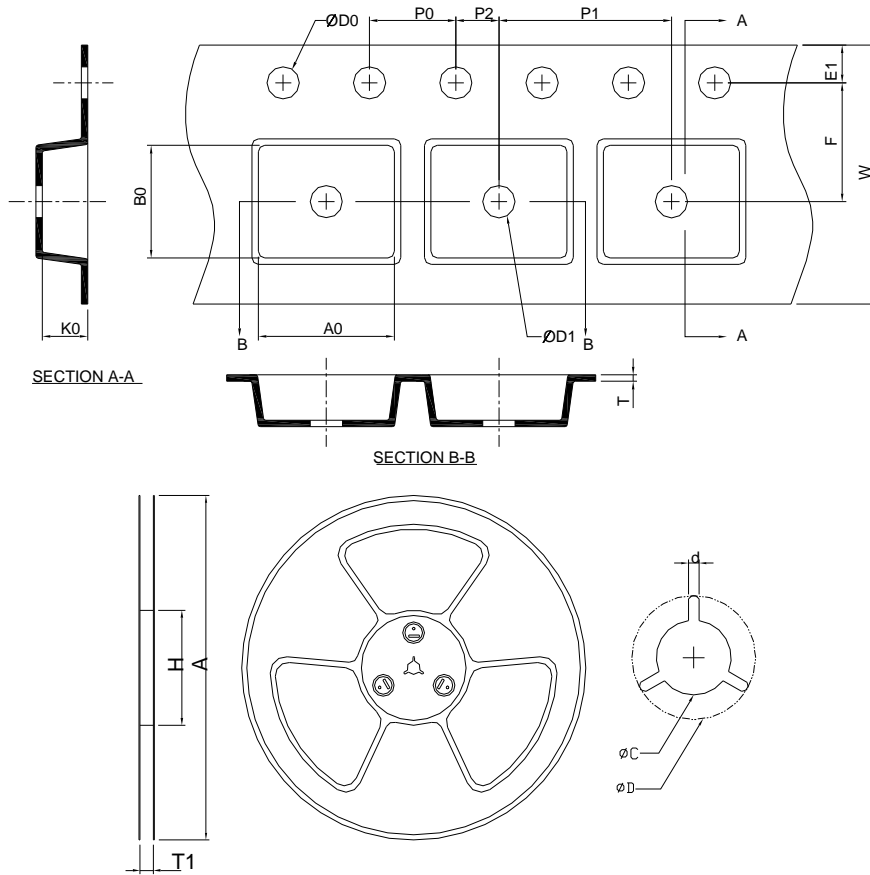

Application	A	H	T1	C	d	D	W	E1	F
TDFN2x3-14	178.0±2.00	50 MIN.	8.4+2.00 -0.00	13.0+0.50 -0.20	1.5 MIN.	20.2 MIN.	8.0±0.20	1.75±0.10	3.50±0.05
	P0	P1	P2	D0	D1	T	A0	B0	K0
	4.0±0.10	4.0±0.10	2.0±0.05	1.5+0.10 -0.00	1.5 MIN.	0.25±0.05	2.30±0.20	3.30±0.20	1.00±0.20

(mm)

Devices Per Unit

Package Type	Unit	Quantity
TDFN2x3-14	Tape & Reel	3000

### Taping Direction Information

TDFN2x3-14

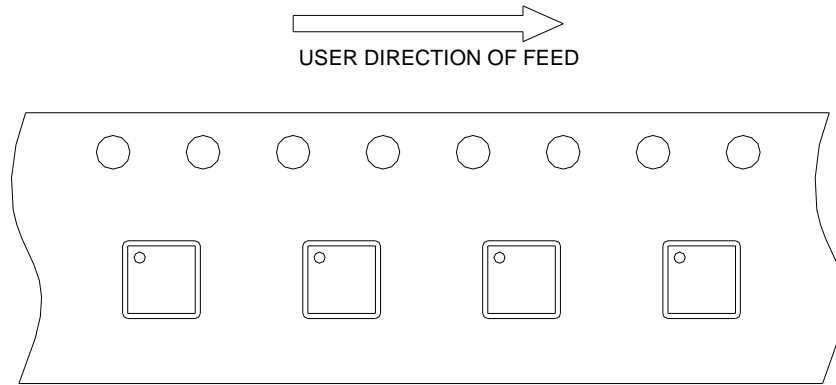

### Classification Profile

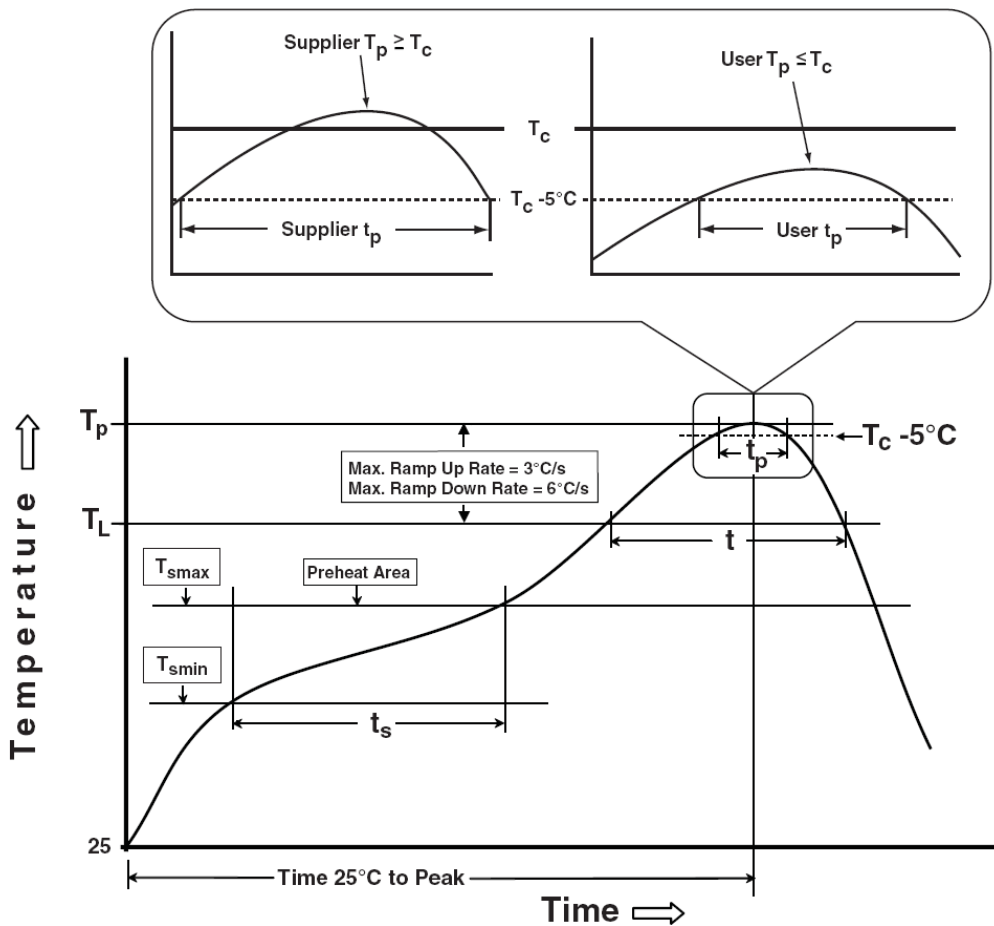

### Classification Reflow Profiles

Profile Feature	Sn-Pb Eutectic Assembly	Pb-Free Assembly
<b>Preheat &amp; Soak</b>		
Temperature min ( $T_{smin}$ )	100 °C	150 °C
Temperature max ( $T_{smax}$ )	150 °C	200 °C
Time ( $T_{smin}$ to $T_{smax}$ ) ( $t_s$ )	60-120 seconds	60-120 seconds
Average ramp-up rate ( $T_{smax}$ to $T_p$ )	3 °C/second max.	3°C/second max.
Liquidous temperature ( $T_L$ )	183 °C	217 °C
Time at liquidous ( $t_L$ )	60-150 seconds	60-150 seconds
Peak package body Temperature ( $T_p$ )*	See Classification Temp in table 1	See Classification Temp in table 2
Time ( $t_p$ )** within 5°C of the specified classification temperature ( $T_c$ )	20** seconds	30** seconds
Average ramp-down rate ( $T_p$ to $T_{smax}$ )	6 °C/second max.	6 °C/second max.
Time 25°C to peak temperature	6 minutes max.	8 minutes max.
* Tolerance for peak profile Temperature ( $T_p$ ) is defined as a supplier minimum and a user maximum.		
** Tolerance for time at peak profile temperature ( $t_p$ ) is defined as a supplier minimum and a user maximum.		

Table 1. SnPb Eutectic Process – Classification Temperatures ( $T_c$ )

Package Thickness	Volume mm <sup>3</sup> <350	Volume mm <sup>3</sup> ≥350
<2.5 mm	235 °C	220 °C
≥2.5 mm	220 °C	220 °C

Table 2. Pb-free Process – Classification Temperatures ( $T_c$ )

Package Thickness	Volume mm <sup>3</sup> <350	Volume mm <sup>3</sup> 350-2000	Volume mm <sup>3</sup> >2000
<1.6 mm	260 °C	260 °C	260 °C
1.6 mm – 2.5 mm	260 °C	250 °C	245 °C
≥2.5 mm	250 °C	245 °C	245 °C

### Reliability Test Program

Test item	Method	Description
SOLDERABILITY	JESD-22, B102	5 Sec, 245°C
HOLT	JESD-22, A108	1000 Hrs, Bias @ $T_j=125^\circ\text{C}$
PCT	JESD-22, A102	168 Hrs, 100%RH, 2atm, 121°C
TCT	JESD-22, A104	500 Cycles, -65°C~150°C
HBM	MIL-STD-883-3015.7	VHBM ≥ 2KV
MM	JESD-22, A115	VMM ≥ 200V
Latch-Up	JESD 78	10ms, $I_{tr} \geq 100\text{mA}$

---

## Customer Service

### **Anpec Electronics Corp.**

Head Office :

No.6, Dusing 1st Road, SBIP,

Hsin-Chu, Taiwan, R.O.C.

Tel : 886-3-5642000

Fax : 886-3-5642050

Taipei Branch :

2F, No. 11, Lane 218, Sec 2 Jhongsing Rd.,

Sindian City, Taipei County 23146, Taiwan

Tel : 886-2-2910-3838

Fax : 886-2-2917-3838