

THICK FILM (GENERAL PURPOSE)

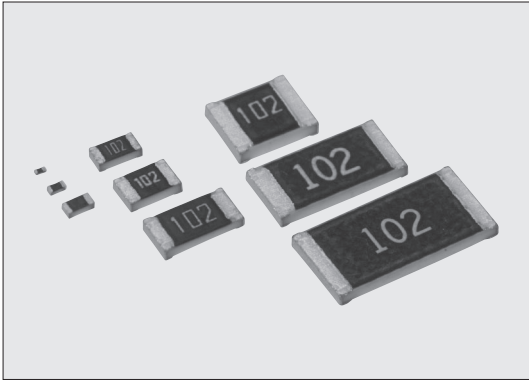

RK73B 矩形片式电阻器 Flat Chip Resistors



外观颜色: 黑色
Coating color: Black

■ 特点 Features

- 小型、轻量。
- 由于电阻器的保护膜使用了金属釉厚膜, 因此耐热性、耐候性优异。
- 电极三层结构, 具有稳定性和高信赖性。
- 对应编带、散装箱方式等各种自动贴装机。
- 对应回流焊、波峰焊。
- 端子无铅电镀品, 符合欧盟RoHS。电极、电阻膜层、玻璃中所含的铅玻璃不适用欧盟RoHS指令。
- AEC-Q200相关数据已取得(除1F)。
- Small size and light weight.
- Excellent heat resistance and weather resistance are ensured by the use of metal glaze thick film.
- High stability and high reliability with the triple-layer structure of electrode.
- Applicable to various kinds of automatic mounters for taping, etc.
- Suitable for both flow and reflow solderings.
- Products with lead free termination meet EU-RoHS requirements. EU-RoHS regulation is not intended for Pb-glass contained in electrode, resistor element and glass.
- AEC-Q200 qualified (Exemption 1F).

■ 品名构成 Type Designation

实例 Example

品种 Product Code	额定功率 Power Rating	端子表面材质 Terminal Surface Material	二次加工 Taping	公称电阻值 Nominal Resistance	阻值允许偏差 Resistance Tolerance
RK73B	1F: 0.03W 1H: 0.05W 1E: 0.1W 1J: 0.125W 2A: 0.25W 2B: 0.25W 2E: 0.5W W2H: 0.75W W3A: 1W W3A2: 2W	T: Sn G: Au ^{※2} (L: Sn/Pb ^{※3})	TX: 4mm width-1mm pitch plastic embossed TBL: TC・TCM: 2mm pitch press paper TFL: TP: 2mm pitch punch paper TD: 4mm pitch punch paper TE: 4mm pitch plastic embossed BK: Bulk	103 3 digits	J: ±2% J: ±5%

※2 镀金电极, 对应1E、1J、2A (10Ω~1MΩ)

由于规格不同, 请向本公司咨询。

※3 1F、1H、W2H、W3A、W3A2尺寸只对应端子表面材质T。
※2 Products with gold plated electrodes are also available with 1E, 1J and 2A types (10Ω~1MΩ), so please consult with us.

※3 With type 1F, 1H, W2H, W3A, W3A2 only T is available as the terminal surface material.

端子表面材质, 以无铅品为准。

欲知关于此产品含有的环境负荷物质详情(除EU-RoHS以外), 请与我们联系。

编带细节参照卷末附录C。

The terminal surface material lead free is standard.

Contact us when you have control request for environmental hazardous material other than the substance specified by EU-RoHS.

For further information on taping, please refer to APPENDIX C on the back pages.

■ 结构图 Construction

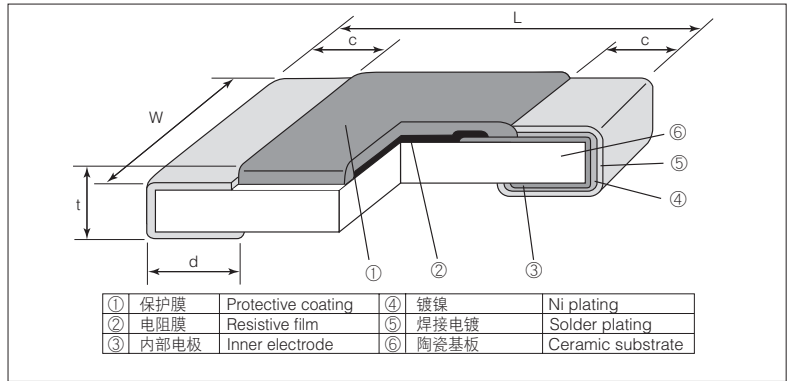

■ 外形尺寸 Dimensions

型号 Type (Inch Size Code)	尺寸 Dimensions (mm)					Weight (g) (1000pcs)
	L	W	c	d	t	
1F (01005)	0.4±0.02	0.2±0.02	0.10±0.03	0.11±0.03	0.13±0.02	0.04
1H (0201)	0.6±0.03	0.3±0.03	0.1±0.05	0.15±0.05	0.23±0.03	0.14
1E (0402)	1.0 ^{+0.1} _{-0.05}	0.5±0.05	0.2±0.1	0.25 ^{+0.05} _{-0.1}	0.35±0.05	0.68
1J (0603)	1.6±0.2	0.8±0.1	0.3±0.1	0.3±0.1	0.45±0.1	2.14
2A (0805)	2.0±0.2	1.25±0.1	0.4±0.2	0.3 ^{+0.2} _{-0.1}	0.5±0.1	4.54
2B (1206)	3.2±0.2	1.6±0.2	0.5±0.3	0.4 ^{+0.2} _{-0.1}	0.6±0.1	9.14
2E (1210)		2.6±0.2				15.5
W2H (2010) ^{※1}	5.0±0.2	2.5±0.2	6.3±0.2	0.65±0.15	0.6±0.1	24.3
W3A (2512) ^{※1}	6.3±0.2	3.1±0.2				37.1
W3A2 (2512) ^{※1}						

※1 也对应RK73B 2H, 3A, 3A2 (“d”尺寸不同。“d”尺寸=0.4^{+0.2}_{-0.1} mm)

※1 RK73B 2H, 3A和3A2 are also still available (different “d” dimensions=0.4^{+0.2}_{-0.1} mm)

■ 负荷减轻特性曲线 Derating Curve

环境温度
Ambient temperature

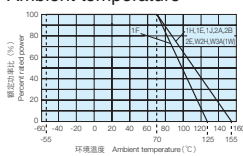

在环境温度70℃以上使用时, 应参照上图负荷减轻特性曲线, 减小额定功率。

For resistors operated at an ambient temperature of 70°C or above, a power rating shall be derated in accordance with the above derating curve.

端子部温度
Terminal part temperature

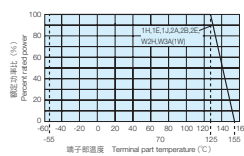

超过上述端子部温度使用时, 请根据负荷减轻特性曲线减小额定功率后使用。

※关于使用方法, 请参照卷首的“端子部温度负荷减轻特性曲线的说明”。

For resistors operated at described for each size or above, a power rating shall be derated in accordance with derating curve.

※Please refer to “Introduction of the derating curves based on the terminal part temperature” on the beginning of our catalog before use.

■ 参考标准 Reference Standards

IEC 60115-8

JIS C 5201-8

EIAJ RC-2134C

■ 额定值 Ratings

型号 Type	额定功率 Power Rating	额定环境温度 Rated Ambient Temp.	额定端子部温度 Rated Terminal Part Temp.	电阻温度系数 T.C.R. ($\times 10^{-6}/K$)	电阻值范围 Resistance Range (Ω)		最高使用电压 Max. Working Voltage	最高过载电压 Max. Overload Voltage	二次加工和包装数量/卷 Packaging & Qty/Reel (pcs)						
					G: $\pm 2\%$ E24	J: $\pm 5\%$ E24			TX	TBL	TC·TCM	TPL·TP	TD	TE	
1F	0.03W	70°C	—	±200	100k~1M	100k~10M	20V	30V	40,000	20,000	—	—	—	—	
					±250	10~91k									10~91k
					0~+300	1~9.1									1~9.1
1H	0.05W	70°C	125°C	±200	10~10M	10~10M	25V	50V	—	—	TC :10,000 TCM:15,000	—	—	—	
					±400	—									1~9.1
1E	0.1W	70°C	125°C	±200	1~10M	1~10M	75V	100V	—	—	—	TPL:20,000 TP :10,000	—	—	
1J	0.1W	70°C	125°C	±200	1.1k~10M	1.1k~10M									
				±400	—	11M~22M									
2A	0.125W	70°C	125°C	±200	1~1k	1~1k	150V	200V	—	—	—	TP :10,000	5,000	—	
					±400	1~1M									1~1M
2B	0.25W	70°C	125°C	±200	1.1M~10M	1.1M~10M	200V	400V	—	—	—	—	5,000	4,000	
					±400	1~5.6M									1~5.6M
2E	0.25W	70°C	125°C	±200	6.2M~10M	6.2M~22M	200V	400V	—	—	—	—	5,000	4,000	
					±400	10~5.6M									1~5.6M
W2H	0.5W	70°C	125°C	±200	—	6.2M~10M	200V	400V	—	—	—	—	—	4,000	
					±400	—									6.2M~22M
W3A	0.75W	70°C	125°C	±200	10~5.6M	1~5.6M	200V	400V	—	—	—	—	—	4,000	
					±400	—									6.2M~22M
W3A2	1.0W	70°C	125°C	±200	10~5.6M	1~5.6M	200V	400V	—	—	—	—	—	4,000	
					±400	—									6.2M~22M
W3A2	2.0W	—	95°C	±200	10~5.6M	1~5.6M	200V	400V	—	—	—	—	—	4,000	
					±400	—									6.2M~22M

使用温度范围 Operating Temperature Range: -55°C~+125°C (1F), -55°C~+155°C (1H•1E•1J•2A•2B•2E•W2H•W3A•W3A2)

额定电压是 $\sqrt{\text{额定功率} \times \text{公称电阻值}}$ 所算出的值或表中最高使用电压两者中小的值为额定电压。

Rated voltage = $\sqrt{\text{Power Rating} \times \text{Resistance value}}$ or Max. working voltage, whichever is lower.

跳线片式电阻器请参照RK73Z系列。

For flat chip jumper resistor, please refer to RK73Z series.

根据客户的使用状况，如果不清楚是该使用额定环境温度还是额定端子部温度，请以额定端子部温度为优先。

详情请参照14~17页的“端子部温度负荷特性曲线的说明”。

If any questions arise whether to use the “Rated Ambient Temperature” or the “Rated Terminal Part Temperature” in your usage conditions, please give priority to the “Rated Terminal Part Temperature”.

For more details, please refer to “Introduction of the derating curves based on the terminal part temperature” in page 14 to 17.

在高功率下使用时，根据基板散热条件的不同，部件温度可能会升高。

请务必在确认端子部温度及产品规格书、使用注意事项后使用。

While using under high power, the temperature of the product may increase depending on the condition of heat dissipation from PCB.

Be sure to check the terminal part temperature as well as precautions to use on delivery specifications before use.

■ 性能 Performance

试验项目 Test Items	标准值 Performance Requirements $\Delta R \pm$ (%+0.1 Ω)		试验方法 Test Methods
	保证值 Limit	代表值 Typical	
电阻值 Resistance	在规定的允许偏差内 Within specified tolerance	—	25°C
电阻温度系数 T.C.R.	在规定的允许偏差内 Within specified T.C.R.	—	+25°C/-55°C and +25°C/+125°C
过载(短时间) Overload (Short time)	2	1: 1F 0.5: another	额定电压 $\times 2.5$ 倍施加5秒钟 (1E, 2B, W3A2: 额定电压 $\times 2$ 倍) Rated voltage $\times 2.5$ for 5s (1E, 2B, W3A2: Rated voltage $\times 2$ for 5s)
耐焊接热 Resistance to soldering heat	1: 1F~W3A2 (10 Ω \leq R \leq 1M Ω) 3: 1F~W3A2 (R < 10 Ω , R > 1M Ω)	0.5: 1F~W3A2 (10 Ω \leq R \leq 1M Ω) 1: 1F~W3A2 (R < 10 Ω , R > 1M Ω)	260°C \pm 5°C, 10s \pm 1s
温度突变 Rapid change of temperature	1: 1F 0.5: another	0.5: 1F 0.3: another	-55°C (30min.) / +125°C (30min.) 100 cycles
耐湿负荷 Moisture resistance	2: 1J, 2A, 2B 3: another	0.75: 1J, 2A, 2B 1.5: 1F 1: another	40°C \pm 2°C, 90%~95%RH, 1000h 1.5小时ON、0.5小时OFF的周期 1.5h ON/0.5h OFF cycle
在70°C时的耐久性 Endurance at 70°C	2: 1J, 2A, 2B 3: another	0.75: 1J, 2A, 2B 1: another	70°C \pm 2°C, 1000h 1.5小时ON、0.5小时OFF的周期 1.5h ON/0.5h OFF cycle
高温放置 High temperature exposure	1	0.5: 1F 0.3: another	+125°C, 1000h: 1F +155°C, 1000h: 1H, 1E, 1J, 2A, 2B, 2E, W2H, W3A, W3A2

■ 使用注意事项 Precautions for Use

● 片状电阻器的基材是氧化铝。由于和安装基板的热膨胀系数不同，在反复施加热循环等热应力时，结合部的焊锡（焊接部）有时会发生龟裂。特别是大型尺寸W2H/W3A/W3A2，由于热膨胀大，而且本身发热也大，使环境温度变动有较大反复和，载荷的ON/OFF有反复时，需要注意裂纹的发生。用环氧树脂印刷电路板（FR-4），在使用温度范围的上、下限进行一般性的热循环试验时，1F~2E的类型不容易发生裂纹，而W2H/W3A/W3A2型则有容易发生裂纹的倾向。因热应力而发生的龟裂，取决于所安装的焊盘的大小、焊锡量、安装基板的散热性等，因此在环境温度有很大的变化或载荷ON/OFF的条件下使用时，请充分注意以进行设计。

● RK73B1F电阻器会因设备组装工序中静电的产生和施加而发生损坏，敬请注意。

● The substrate of chip resistors is alumina. Cracks may occur at the connection of solder (solder fillet portion) due to the difference of the coefficient of thermal expansion from a mounting board when heat stress like heat cycle, etc. are repeatedly given to them. Care should be taken to the occurrence of the cracks when the change in ambient temperature or ON/OFF of load is repeated, especially when large types of W2H/W3A/W3A2 which have large thermal expansion and also self heating. By general temperature cycle test using glass-epoxy (FR-4) boards under the maximum/minimum temperatures of operating temperature range, the crack does not occur easily in the types of 1F~2E, but the crack tends to occur in the types of W2H/W3A/W3A2. The occurrence of the crack by heat stress may be influenced by the size of a pad, solder volume, heat radiation of mounting board etc., so please pay careful attention to designing when a big change in ambient temperature and conditions for use like ON/OFF of load can be assumed.

● Care should be taken that RK73B1F may be damaged when static electricity occurs and is applied in the equipment assembly process.