

Specification for Approval

Date: 2018/3/21

Customer : 深圳臺慶

TAI-TECH P/N: ACM3225F2SF-102T15

CUSTOMER P/N: _____

DESCRIPTION: _____

QUANTITY: _____ pcs

REMARK:		
Customer Approval Feedback		

西北臺慶科技股份有限公司
 西 TAI-TECH Advanced Electronics Co., Ltd
Headquarter:
 NO.1 YOU 4TH ROAD, YOUTH INDUSTRIAL DISTRICT, YANG-MEI,
 TAO-YUAN HSIEN, TAIWAN, R.O.C.
 TEL: +886-3-4641148 FAX: +886-3-4643565
 http://www.tai-tech.com.tw
 E-mail: sales@tai-tech.com.tw

Office:
 深圳辦公室
 11BC, Building B Fortune Plaza, NO.7002, Shennan Avenue, Futian
 District Shenzhen
 TEL: +86-755-23972371 FAX: +86-755-23972340

臺慶精密電子(昆山)有限公司
 TAI-TECH ADVANCED ELECTRONICS(KUNSHAN) CO., LTD
 SHINWHA ROAD, KUNJIA HI-TECH INDUSTRIAL PARK, KUN-SHAN,
 JIANG-SU, CHINA
 TEL: +86-512-57619396 FAX: +86-512-57619688
 E-mail: sales@tai-tech.cn

慶邦電子元器件(泗洪)有限公司
 TAIPAQ ELECTRONICS (SIHONG) CO., LTD
 Sihong development zone Suqian City, Jiangsu , CHINA.
 TEL: +86-527-88601191 FAX: +86-527-88601190
 E-mail: sales@taipaq.cn

Sales Dep.

APPROVED	CHECKED
管哲頌 Eric Guan	曾詩涵 Angela Tseng

R&D Center

APPROVED	CHECKED	DRAWN
楊祥忠 Mike Yang	林志鴻 Zhi-Hong Lin	張嘉玲 Alin Chang

Wire Wound Type Common Mode Filter

ACM3225F2SF-102T15

1. Features

- High common mode impedance at high frequency effects excellent noise suppression performance.
- ACM3225F2SF series realizes small size and low profile 3.2x2.5x2.2 mm
- 100% Lead(Pb) & Halogen-Free and RoHS compliant.



2. Dimension

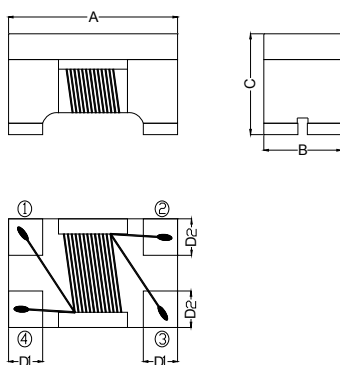

Recommended PC Board Pattern

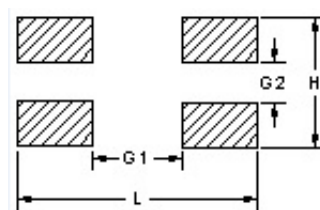

Series	A(mm)	B(mm)	C(mm)	D1(mm)	D2(mm)	L(mm)	H(mm)	G1(mm)	G2(mm)
3225F2SF	3.2±0.2	2.5±0.2	2.2±0.2	0.65±0.1	1.0±0.1	4.4	3.5	2.3	0.8

Units: mm

3. Part Numbering



- A: Series
 B: Dimension
 C: Material Ferrite Core
 D: Number of Lines 2=2 lines
 E: Type S=Shielded , N=Unshielded
 F: Lead free
 G: Impedance 102=1000Ω
 H: Packaging T=Taping and Reel
 I: Rated Current 15=1500mA

4. Specification

TAI-TECH Part Number	Common mode Impedance (Ω)	Test Frequency (MHz)	DC Resistance (Ω) max.	Rated Current (mA)max.	Rated Volt. (Vdc)max.	IR (MΩ) min.
ACM3225F2SF-102T15	1000±25%	100	0.10	1500	60	10

Note:

- Test Frequency : Impedance:100MHz
- Testing Instrument : L:Agilent-4291A,Agilent-16197A DCR: Agilent-4338B
- Operating temperature -40℃ ~ +85℃
- All test data is referenced to 25℃ ambient.

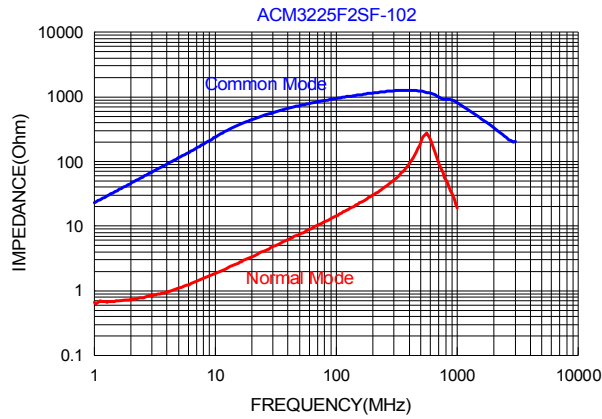

5. Schematic Diagram

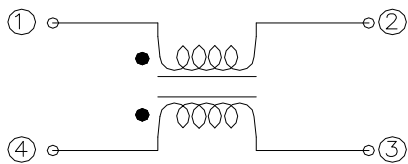

6. MEASURING CIRCUITS 2LINE

Common mode

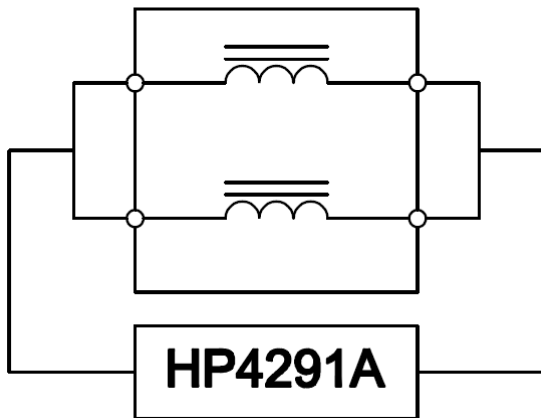

Differential mode

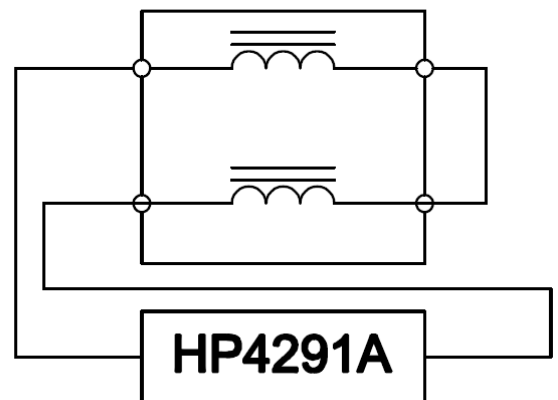

7. Materials

No.	Description	Specification
a.	Upper Plate	Ferrite
b.	Core	Ferrite Core
c.	Termination	Tin (Pb Free)
d.	Wire	Enameled Copper Wire

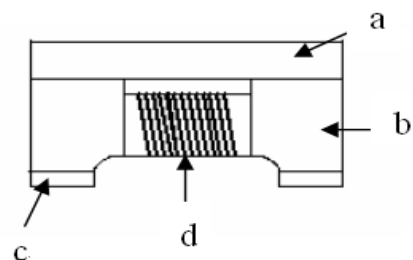

8. Reliability and Test Condition

Item	Performance	Test Condition
Operating temperature	-40~+85℃ (Including self - temperature rise)	
Storage temperature	-40~+85℃ (on board)	
Electrical Performance Test		
Z(common mode)	Refer to standard electrical characteristics list.	Agilent-4291A+ Agilent -16197A
DCR		Agilent-4338B
I.R.		Agilent4339
Temperature Rise Test	Rated Current < 1A ΔT 20℃ Max Rated Current \geq 1A ΔT 40℃ Max	1.Applied the allowed DC current. 2.Temperature measured by digital surface thermometer
Reliability Test		
Life Test	Appearance : No damage. Inductance : within \pm 10% of initial value Impedance : within \pm 15% of initial value RDC : within \pm 15% of initial value and shall not exceed the specification value	Preconditioning: Run through IR reflow for 2 times.(IPC/JEDEC J-STD-020DCClassification Reflow Profiles) Temperature : 85 \pm 2℃ Applied current : rated current Duration : 1000 \pm 12hrs Measured at room temperature after placing for 24 \pm 2 hrs
Load Humidity		Preconditioning: Run through IR reflow for 2 times.(IPC/JEDEC J-STD-020DCClassification Reflow Profiles) Humidity : 85 \pm 2%R.H, Temperature : 85℃ \pm 2℃ Duration : 1000hrs Min. with 100% rated current Measured at room temperature after placing for 24 \pm 2 hrs
Moisture Resistance		Preconditioning: Run through IR reflow for 2 times.(IPC/JEDEC J-STD-020DCClassification Reflow Profiles 1. Baked at50℃ for 25hrs, measured at room temperature after placing for 4 hrs. 2. Raise temperature to 65 \pm 2℃ 90-100%RH in 2.5hrs, and keep 3 hours, cool down to 25℃ in 2.5hrs. 3. Raise temperature to 65 \pm 2℃ 90-100%RH in 2.5hrs, and keep 3 hours, cool down to 25℃ in 2.5hrs,keep at 25℃ for 2 hrs then keep at -10℃ for 3 hrs 4. Keep at 25℃ 80-100%RH for 15min and vibrate at the frequency of 10 to 55 Hz to 10 Hz, measure at room temperature after placing for 1~2 hrs.
Thermal shock		Preconditioning: Run through IR reflow for 2 times.(IPC/JEDEC J-STD-020DCClassification Reflow Profiles Condition for 1 cycle Step1 : -40 \pm 2℃ 30 \pm 5min Step2 : 25 \pm 2℃ \leq 0.5min Step3 : 85 \pm 2℃ 30 \pm 5min Number of cycles : 500 Measured at room temperature after placing for 24 \pm 2 hrs
Vibration		Oscillation Frequency: 10 ~ 2K ~ 10Hz for 20 minutes Equipment : Vibration checker Total Amplitude:1.52mm \pm 10% Testing Time : 12 hours(20 minutes, 12 cycles each of 3 orientations)。

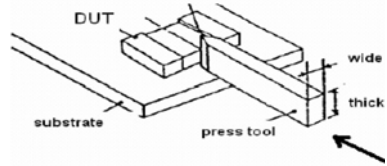
Item	Performance	Test Condition															
Bending	Appearance : No damage. Impedance : within±15% of initial value Inductance : within±10% of initial value Q : Shall not exceed the specification value. RDC : within ±15% of initial value and shall not exceed the specification value	Shall be mounted on a FR4 substrate of the following dimensions: >=0805 inch(2012mm):40x100x1.2mm <0805 inch(2012mm):40x100x0.8mm Bending depth: >=0805 inch(2012mm):1.2mm <0805 inch(2012mm):0.8mm duration of 10 sec.															
Shock	Appearance : No damage. Impedance : within±15% of initial value Inductance : within±10% of initial value Q : Shall not exceed the specification value. RDC : within ±15% of initial value and shall not exceed the specification value	<table border="1"> <thead> <tr> <th>Type</th> <th>Peak value (g's)</th> <th>Normal duration (D) (ms)</th> <th>Wave form</th> <th>Velocity change (V)ft/sec</th> </tr> </thead> <tbody> <tr> <td>SMD</td> <td>50</td> <td>11</td> <td>Half-sine</td> <td>11.3</td> </tr> <tr> <td>Lead</td> <td>50</td> <td>11</td> <td>Half-sine</td> <td>11.3</td> </tr> </tbody> </table>	Type	Peak value (g's)	Normal duration (D) (ms)	Wave form	Velocity change (V)ft/sec	SMD	50	11	Half-sine	11.3	Lead	50	11	Half-sine	11.3
Type	Peak value (g's)	Normal duration (D) (ms)	Wave form	Velocity change (V)ft/sec													
SMD	50	11	Half-sine	11.3													
Lead	50	11	Half-sine	11.3													
Solder ability	More than 95% of the terminal electrode should be covered with solder.	Preheat: 150°C, 60sec. ◦ Solder: Sn96.5% Ag3% Cu0.5% Temperature: 245±5°C ◦ Flux for lead free: Rosin. 9.5% ◦ Dip time: 4±1sec ◦ Depth: completely cover the termination Depth: completely cover the termination															
Resistance to Soldering Heat		<table border="1"> <thead> <tr> <th>Temperature(°C)</th> <th>Time(s)</th> <th>Temperature ramp/immersion and emersion rate</th> <th>Number of heat cycles</th> </tr> </thead> <tbody> <tr> <td>260 ±5 (solder temp)</td> <td>10 ±1</td> <td>25mm/s ±6 mm/s</td> <td>1</td> </tr> </tbody> </table>	Temperature(°C)	Time(s)	Temperature ramp/immersion and emersion rate	Number of heat cycles	260 ±5 (solder temp)	10 ±1	25mm/s ±6 mm/s	1							
Temperature(°C)	Time(s)	Temperature ramp/immersion and emersion rate	Number of heat cycles														
260 ±5 (solder temp)	10 ±1	25mm/s ±6 mm/s	1														
Terminal Strength	Appearance : No damage. Impedance : within±15% of initial value Inductance : within±10% of initial value Q : Shall not exceed the specification value. RDC : within ±15% of initial value and shall not exceed the specification value	Preconditioning: Run through IR reflow for 2 times.(IPC/JEDEC J-STD-020DClassification Reflow Profiles With the component mounted on a PCB with the device to be tested, apply a force(>0805:1kg , <=0805:0.5kg)to the side of a device being tested. This force shall be applied for 60 +1 seconds. Also the force shall be applied gradually as not to apply a shock to the component being tested. 															

9. Soldering and Mounting

9-1. Soldering

Mildly activated rosin fluxes are preferred. TAI-TECH terminations are suitable for all wave and re-flow soldering systems. If hand soldering cannot be avoided, the preferred technique is the utilization of hot air soldering tools.

9-1.1 Solder re-flow:

Recommended temperature profiles for re-flow soldering in Figure 1.

9-1.2 Soldering Iron(Figure 2):

Products attachment with a soldering iron is discouraged due to the inherent process control limitations. In the event that a soldering iron must be employed the following precautions are recommended.

- Preheat circuit and products to 150°C
- Never contact the ceramic with the iron tip
- Use a 20 watt soldering iron with tip diameter of 1.0mm
- 355°C tip temperature (max)
- 1.0mm tip diameter (max)
- Limit soldering time to 4~5 sec.

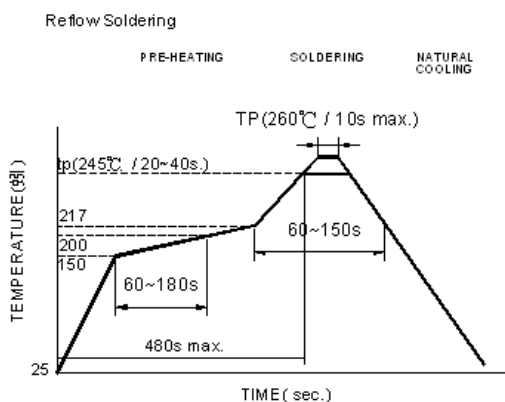

Reflow times: 3 times max.

Fig.1

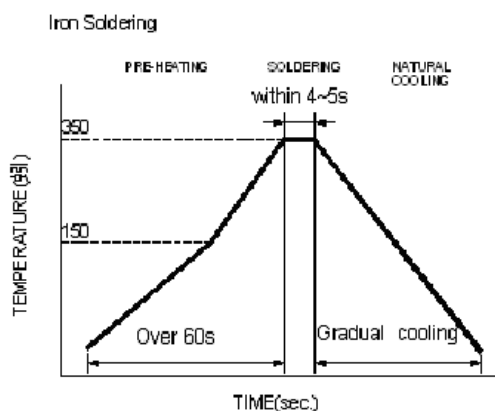

Iron Soldering times: 1 times max.

Fig.2

10. Packaging Information

10-1. Reel Dimension

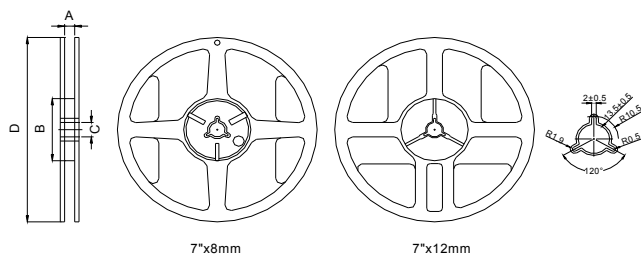

Type	A(mm)	B(mm)	C(mm)	D(mm)
7"x8mm	9.0±0.5	60±2	13.5±0.5	178±2

10-2. Tape Dimension / 8mm

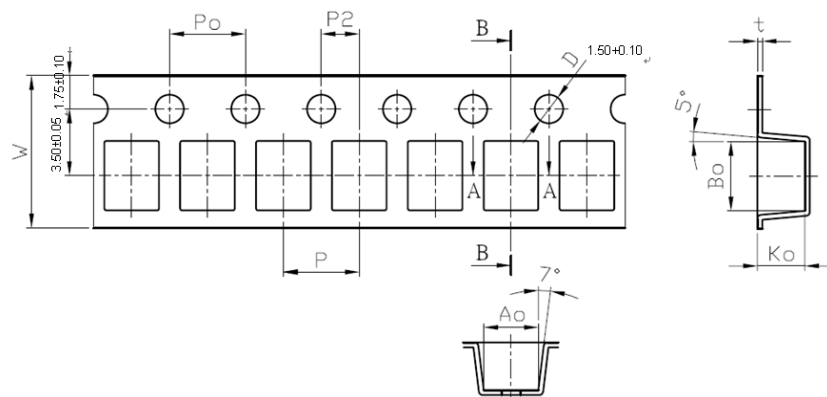

Series	P(mm)	Po(mm)	P2(mm)	Bo(mm)	Ao(mm)	Ko(mm)	W(mm)	t(mm)
ACM3225	4.00±0.10	4.00±0.10	2.00±0.05	3.65±0.10	2.88±0.10	2.50±0.10	8.00±0.10	0.26±0.05

10-3. Packaging Quantity

Chip size	Chip/Reel	Inner Box	Middle Box	Carton
ACM3225F2S	2000	10000	50000	100000

10-4. Tearing Off Force

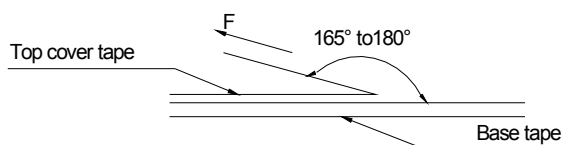

The force for tearing off cover tape is 15 to 80 grams in the arrow direction under the following conditions.

Room Temp. (°C)	Room Humidity (%)	Room atm (hPa)	Tearing Speed mm/min
5~35	45~85	860~1060	300

Application Notice

- Storage Conditions(component level)
 - To maintain the solderability of terminal electrodes:
 - TAI-TECH products meet IPC/JEDEC J-STD-020D standard-MSL, level 1.
 - Temperature and humidity conditions: Less than 40°C and 60% RH.
 - Recommended products should be used within 12 months form the time of delivery.
 - The packaging material should be kept where no chlorine or sulfur exists in the air.
- Transportation
 - Products should be handled with care to avoid damage or contamination from perspiration and skin oils.
 - The use of tweezers or vacuum pick up is strongly recommended for individual components.
 - Bulk handling should ensure that abrasion and mechanical shock are minimized.

測試報告

Test Report

號碼(No.) : CE/2017/95671

日期(Date) : 2017/10/06

頁數(Page): 1 of 16

西北臺慶科技股份有限公司 / TAI-TECH ADVANCED ELECTRONICS CO., LTD.

(臺慶精密電子(昆山)有限公司 / TAI-TECH ADVANCED ELECTRONICS (KUN-SHAN) CO. LTD.)

(慶邦電子元器件(泗洪)有限公司 / TAIPAQ ELECTRONICS (SI-HONG) CO., LTD.)

桃園市楊梅區幼獅工業區幼四路1號 / NO. 1, YOU 4TH ROAD, YOUTH INDUSTRIAL DISTRICT, YANG-MEI, TAO-YUAN CITY, TAIWAN, R. O. C.

(江蘇省昆山市蓬朗區嘉高科技工業區郭澤路 / GUO-ZE ROAD, KUNJIA HI-TECH INDUSTRIAL PARK, KUN-SHAN, JIANG-SU, CHINA)

(中國, 江蘇省, 宿遷市, 泗洪縣, 經濟開發區杭州路南側, 建設北路東側 / THE SOUTH HANGZHOU ROAD AND THE EAST JIANSHE ROAD, ECONOMIC DEVELOPMENT ZONE, SIHONG COUNTY, SUQIANCITY, JIANGSU PROVINCE, P, R, CHINA)

以下測試樣品係由申請廠商所提供及確認 (The following sample(s) was/were submitted and identified by/on behalf of the applicant as):

樣品名稱(Sample Description) : WIREWOUND SERIES
樣品型號(Style/Item No.) : WCM、WCL、HSF、HDMI、DVI、BCM、PCM、TCM、LCM、LPF、TXF、ACM、DCM、WIH、BPH、TNH SERIES
收件日期(Sample Receiving Date) : 2017/09/29
測試期間(Testing Period) : 2017/09/29 TO 2017/10/06

測試結果(Test Results) : 請參閱下一頁 (Please refer to following pages).

Troy Chang, Manager - Tech
Signed for and on behalf of
SGS TAIWAN LTD.
Chemical Laboratory - Taipei



This document is issued by the Company subject to its General Conditions of Service printed overleaf, available on request or accessible at <http://www.sgs.com/en/Terms-and-Conditions.aspx> and, for electronic format documents, subject to Terms and Conditions for Electronic Documents at <http://www.sgs.com/en/Terms-and-Conditions-for-Electronic-Document.aspx>. Attention is drawn to the limitation of liability, indemnification and jurisdiction issues defined therein. Any holder of this document is advised that information contained hereon reflects the Company's findings at the time of its intervention only and within the limits of client's instruction, if any. The Company's sole responsibility is to its Client and this document does not exonerate parties to a transaction from exercising all their rights and obligations under the transaction documents. This document cannot be reproduced, except in full, without prior written approval of the Company. Any unauthorized alteration, forgery or falsification of the content or appearance of this document is unlawful and offenders may be prosecuted to the fullest extent of the law. Unless otherwise stated the results shown in this test report refer only to the sample(s) tested.



測試報告

Test Report

號碼(No.) : CE/2017/95671

日期(Date) : 2017/10/06

頁數(Page): 2 of 16

西北臺慶科技股份有限公司 / TAI-TECH ADVANCED ELECTRONICS CO., LTD.



(臺慶精密電子(昆山)有限公司 / TAI-TECH ADVANCED ELECTRONICS (KUN-SHAN) CO. LTD.)

(慶邦電子元器件(泗洪)有限公司 / TAIPAQ ELECTRONICS (SI-HONG) CO., LTD.)

桃園市楊梅區幼獅工業區幼四路1號 / NO. 1, YOU 4TH ROAD, YOUTH INDUSTRIAL DISTRICT, YANG-MEI, TAO-YUAN CITY, TAIWAN, R. O. C.

(江蘇省昆山市蓬朗昆嘉高科技工業區郭澤路 / GUO-ZE ROAD, KUNJIA HI-TECH INDUSTRIAL PARK, KUN-SHAN, JIANG-SU, CHINA)

(中國, 江蘇省, 宿遷市, 泗洪縣, 經濟開發區杭州路南側, 建設北路東側 / THE SOUTH HANGZHOU ROAD AND THE EAST JIANSHE ROAD, ECONOMIC DEVELOPMENT ZONE, SIHONG COUNTY, SUQIANCITY, JIANGSU PROVINCE, P, R, CHINA)

測試結果(Test Results)

測試部位(PART NAME)No.1 : 整體混測 (MIXED ALL PARTS)

測試項目 (Test Items)	單位 (Unit)	測試方法 (Method)	方法偵測 極限值 (MDL)	結果 (Result)
				No. 1
鎘 / Cadmium (Cd)	mg/kg	參考IEC 62321-5 (2013), 以感應耦合電漿原子發射光譜儀檢測. / With reference to IEC 62321-5 (2013) and performed by ICP-AES.	2	n. d.
鉛 / Lead (Pb)	mg/kg	參考IEC 62321-5 (2013), 以感應耦合電漿原子發射光譜儀檢測. / With reference to IEC 62321-5 (2013) and performed by ICP-AES.	2	n. d.
汞 / Mercury (Hg)	mg/kg	參考IEC 62321-4 (2013), 以感應耦合電漿原子發射光譜儀檢測. / With reference to IEC 62321-4 (2013) and performed by ICP-AES.	2	n. d.
六價鉻 / Hexavalent Chromium Cr(VI) (◆)	mg/kg	參考IEC 62321-7-2 (2017), 以UV-VIS檢測; 參考IEC 62321-5 (2013), 以ICP-AES檢測. / With reference to IEC 62321-7-2 (2017) and performed by UV-VIS. ; With reference to IEC 62321-5 (2013) and performed by ICP-AES.	8	n. d.
銻 / Antimony (Sb)	mg/kg	參考US EPA 3050B (1996), 以感應耦合電漿原子發射光譜儀檢測. / With reference to US EPA 3050B (1996). Analysis was performed by ICP-AES.	2	n. d.

This document is issued by the Company subject to its General Conditions of Service printed overleaf, available on request or accessible at <http://www.sgs.com/Terms-and-Conditions.aspx> and, for electronic format documents, subject to Terms and Conditions for Electronic Documents at <http://www.sgs.com/ET/ET-terms-and-conditions.aspx>. Attention is drawn to the limitation of liability, indemnification and jurisdiction issues defined therein. Any holder of this document is advised that information contained hereon reflects the Company's findings at the time of its intervention only and within the limits of client's instruction, if any. The Company's sole responsibility is to its Client and this document does not exonerate parties to a transaction from exercising all their rights and obligations under the transaction documents. This document cannot be reproduced, except in full, without prior written approval of the Company. Any unauthorized alteration, forgery or falsification of the content or appearance of this document is unlawful and offenders may be prosecuted to the fullest extent of the law. Unless otherwise stated the results shown in this test report refer only to the sample(s) tested.



測試報告

Test Report

號碼(No.) : CE/2017/95671

日期(Date) : 2017/10/06

頁數(Page): 3 of 16

西北臺慶科技股份有限公司 / TAI-TECH ADVANCED ELECTRONICS CO., LTD.



(臺慶精密電子(昆山)有限公司 / TAI-TECH ADVANCED ELECTRONICS (KUN-SHAN) CO. LTD.)

(慶邦電子元器件(泗洪)有限公司 / TAIPAQ ELECTRONICS (SI-HONG) CO., LTD.)

桃園市楊梅區幼獅工業區幼四路1號 / NO. 1, YOU 4TH ROAD, YOUTH INDUSTRIAL DISTRICT, YANG-MEI, TAO-YUAN CITY, TAIWAN, R. O. C.

(江蘇省昆山市蓬朗昆嘉高科技工業區郭澤路 / GUO-ZE ROAD, KUNJIA HI-TECH INDUSTRIAL PARK, KUN-SHAN, JIANG-SU, CHINA)

(中國, 江蘇省, 宿遷市, 泗洪縣, 經濟開發區杭州路南側, 建設北路東側 / THE SOUTH HANGZHOU ROAD AND THE EAST JIANSHE ROAD, ECONOMIC DEVELOPMENT ZONE, SIHONG COUNTY, SUQIANCITY, JIANGSU PROVINCE, P, R, CHINA)

測試項目 (Test Items)	單位 (Unit)	測試方法 (Method)	方法偵測 極限值 (MDL)	結果 (Result)
				No. 1
鈹 / Beryllium (Be)	mg/kg	參考US EPA 3050B (1996), 以感應耦合電漿原子發射光譜儀檢測. / With reference to US EPA 3050B (1996). Analysis was performed by ICP-AES.	2	n. d.
全氟辛烷磺酸 / Perfluorooctane sulfonates (PFOS-Acid, Metal Salt, Amide)	mg/kg	參考US EPA 3550C (2007), 以液相層析/質譜儀檢測. / With reference to US EPA 3550C (2007). Analysis was performed by LC/MS.	10	n. d.
全氟辛酸 / PFOA (CAS No.: 335-67-1)	mg/kg	參考US EPA 3550C (2007), 以液相層析/質譜儀檢測. / With reference to US EPA 3550C (2007). Analysis was performed by LC/MS.	10	n. d.
聚氯乙烯 / PVC	**	以紅外光譜分析及焰色法檢測. / Analysis was performed by FTIR and FLAME Test.	-	Negative
六溴環十二烷及所有主要被辨別出的異構物 / Hexabromocyclododecane (HBCDD) and all major diastereoisomers identified (α -HBCDD, β -HBCDD, γ -HBCDD) (CAS No.: 25637-99-4 and 3194-55-6 (134237-51-7, 134237-50-6, 134237-52-8))	mg/kg	參考IEC 62321 (2008), 以氣相層析/質譜儀檢測. / With reference to IEC 62321 (2008). Analysis was performed by GC/MS.	5	n. d.

This document is issued by the Company subject to its General Conditions of Service printed overleaf, available on request or accessible at <http://www.sgs.com.tw/terms-and-conditions.aspx> and, for electronic format documents, subject to Terms and Conditions for Electronic Documents at <http://www.sgs.com.tw/terms-and-conditions.aspx>. Attention is drawn to the limitation of liability, indemnification and jurisdiction issues defined therein. Any holder of this document is advised that information contained hereon reflects the Company's findings at the time of its intervention only and within the limits of client's instruction, if any. The Company's sole responsibility is to its Client and this document does not exonerate parties to a transaction from exercising all their rights and obligations under the transaction documents. This document cannot be reproduced, except in full, without prior written approval of the Company. Any unauthorized alteration, forgery or falsification of the content or appearance of this document is unlawful and offenders may be prosecuted to the fullest extent of the law. Unless otherwise stated the results shown in this test report refer only to the sample(s) tested.



測試報告

Test Report

號碼(No.) : CE/2017/95671 日期(Date) : 2017/10/06

頁數(Page): 4 of 16

西北臺慶科技股份有限公司 / TAI-TECH ADVANCED ELECTRONICS CO., LTD.

(臺慶精密電子(昆山)有限公司 / TAI-TECH ADVANCED ELECTRONICS (KUN-SHAN) CO. LTD.)

(慶邦電子元器件(泗洪)有限公司 / TAIPAQ ELECTRONICS (SI-HONG) CO., LTD.)

桃園市楊梅區幼獅工業區幼四路1號 / NO. 1, YOU 4TH ROAD, YOUTH INDUSTRIAL DISTRICT, YANG-MEI, TAO-YUAN CITY, TAIWAN, R. O. C.

(江蘇省昆山市蓬朗昆嘉高科技工業區郭澤路 / GUO-ZE ROAD, KUNJIA HI-TECH INDUSTRIAL PARK, KUN-SHAN, JIANG-SU, CHINA)

(中國, 江蘇省, 宿遷市, 泗洪縣, 經濟開發區杭州路南側, 建設北路東側 / THE SOUTH HANGZHOU ROAD AND THE EAST JIANSHE ROAD, ECONOMIC DEVELOPMENT ZONE, SIHONG COUNTY, SUQIANCITY, JIANGSU PROVINCE, P, R, CHINA)



測試項目 (Test Items)	單位 (Unit)	測試方法 (Method)	方法偵測 極限值 (MDL)	結果 (Result)
				No. 1
鄰苯二甲酸丁苯甲酯 / BBP (Butyl Benzyl phthalate) (CAS No. : 85-68-7)	mg/kg	參考IEC 62321-8 (2017), 以氣相層析儀/質譜儀檢測。 / With reference to IEC 62321-8 (2017). Analysis was performed by GC/MS.	50	n. d.
鄰苯二甲酸二丁酯 / DBP (Dibutyl phthalate) (CAS No. : 84-74-2)	mg/kg		50	n. d.
鄰苯二甲酸二(2-乙基己基)酯 / DEHP (Di-(2-ethylhexyl) phthalate) (CAS No. : 117-81-7)	mg/kg		50	n. d.
鄰苯二甲酸二異丁酯 / DIBP (Di-isobutyl phthalate) (CAS No. : 84-69-5)	mg/kg		50	n. d.
鄰苯二甲酸二異癸酯 / DIDP (Di-isodecyl phthalate) (CAS No. : 26761-40-0; 68515-49-1)	mg/kg		50	n. d.
鄰苯二甲酸二異壬酯 / DINP (Di-isononyl phthalate) (CAS No. : 28553-12-0; 68515-48-0)	mg/kg		50	n. d.
鄰苯二甲酸二正辛酯 / DNOP (Di-n-octyl phthalate) (CAS No. : 117-84-0)	mg/kg		50	n. d.
鄰苯二甲酸二正己酯 / DNHP (Di-n-hexyl phthalate) (CAS No. : 84-75-3)	mg/kg		50	n. d.
鄰苯二甲酸二戊酯 / Di-n-pentyl phthalate (CAS No. : 131-18-0)	mg/kg		50	n. d.

This document is issued by the Company subject to its General Conditions of Service printed overleaf, available on request or accessible at <http://www.sgs.com/en/Terms-and-Conditions.aspx> and, for electronic format documents, subject to Terms and Conditions for Electronic Documents at <http://www.sgs.com/en/Terms-and-Conditions/Terms-Document.aspx>. Attention is drawn to the limitation of liability, indemnification and jurisdiction issues defined therein. Any holder of this document is advised that information contained hereon reflects the Company's findings at the time of its intervention only and within the limits of client's instruction, if any. The Company's sole responsibility is to its Client and this document does not exonerate parties to a transaction from exercising all their rights and obligations under the transaction documents. This document cannot be reproduced, except in full, without prior written approval of the Company. Any unauthorized alteration, forgery or falsification of the content or appearance of this document is unlawful and offenders may be prosecuted to the fullest extent of the law. Unless otherwise stated the results shown in this test report refer only to the sample(s) tested.



測試報告

Test Report

號碼(No.) : CE/2017/95671

日期(Date) : 2017/10/06

頁數(Page): 5 of 16

西北臺慶科技股份有限公司 / TAI-TECH ADVANCED ELECTRONICS CO., LTD.



(臺慶精密電子(昆山)有限公司 / TAI-TECH ADVANCED ELECTRONICS (KUN-SHAN) CO. LTD.)

(慶邦電子元器件(泗洪)有限公司 / TAIPAQ ELECTRONICS (SI-HONG) CO., LTD.)

桃園市楊梅區幼獅工業區幼四路1號 / NO. 1, YOU 4TH ROAD, YOUTH INDUSTRIAL DISTRICT, YANG-MEI, TAO-YUAN CITY, TAIWAN, R. O. C.

(江蘇省昆山市蓬朗昆嘉高科技工業區郭澤路 / GUO-ZE ROAD, KUNJIA HI-TECH INDUSTRIAL PARK, KUN-SHAN, JIANG-SU, CHINA)

(中國, 江蘇省, 宿遷市, 泗洪縣, 經濟開發區杭州路南側, 建設北路東側 / THE SOUTH HANGZHOU ROAD AND THE EAST JIANSHE ROAD, ECONOMIC DEVELOPMENT ZONE, SIHONG COUNTY, SUQIANCITY, JIANGSU PROVINCE, P, R, CHINA)

測試項目 (Test Items)	單位 (Unit)	測試方法 (Method)	方法偵測 極限值 (MDL)	結果 (Result)
				No. 1
多溴聯苯總和 / Sum of PBBs	mg/kg	參考IEC 62321-6 (2015), 以氣相層析 / 質譜儀檢測. / With reference to IEC 62321-6 (2015) and performed by GC/MS.	-	n. d.
一溴聯苯 / Monobromobiphenyl	mg/kg		5	n. d.
二溴聯苯 / Dibromobiphenyl	mg/kg		5	n. d.
三溴聯苯 / Tribromobiphenyl	mg/kg		5	n. d.
四溴聯苯 / Tetrabromobiphenyl	mg/kg		5	n. d.
五溴聯苯 / Pentabromobiphenyl	mg/kg		5	n. d.
六溴聯苯 / Hexabromobiphenyl	mg/kg		5	n. d.
七溴聯苯 / Heptabromobiphenyl	mg/kg		5	n. d.
八溴聯苯 / Octabromobiphenyl	mg/kg		5	n. d.
九溴聯苯 / Nonabromobiphenyl	mg/kg		5	n. d.
十溴聯苯 / Decabromobiphenyl	mg/kg		5	n. d.
多溴聯苯醚總和 / Sum of PBDEs	mg/kg		-	n. d.
一溴聯苯醚 / Monobromodiphenyl ether	mg/kg		5	n. d.
二溴聯苯醚 / Dibromodiphenyl ether	mg/kg		5	n. d.
三溴聯苯醚 / Tribromodiphenyl ether	mg/kg		5	n. d.
四溴聯苯醚 / Tetrabromodiphenyl ether	mg/kg		5	n. d.
五溴聯苯醚 / Pentabromodiphenyl ether	mg/kg		5	n. d.
六溴聯苯醚 / Hexabromodiphenyl ether	mg/kg		5	n. d.
七溴聯苯醚 / Heptabromodiphenyl ether	mg/kg		5	n. d.
八溴聯苯醚 / Octabromodiphenyl ether	mg/kg		5	n. d.
九溴聯苯醚 / Nonabromodiphenyl ether	mg/kg	5	n. d.	
十溴聯苯醚 / Decabromodiphenyl ether	mg/kg	5	n. d.	

This document is issued by the Company subject to its General Conditions of Service printed overleaf, available on request or accessible at <http://www.sgs.com/en/Terms-and-Conditions.aspx> and, for electronic format documents, subject to Terms and Conditions for Electronic Documents at <http://www.sgs.com/en/Terms-and-Conditions-for-Electronic-Documents.aspx>. Attention is drawn to the limitation of liability, indemnification and jurisdiction issues defined therein. Any holder of this document is advised that information contained hereon reflects the Company's findings at the time of its intervention only and within the limits of client's instruction, if any. The Company's sole responsibility is to its Client and this document does not exonerate parties to a transaction from exercising all their rights and obligations under the transaction documents. This document cannot be reproduced, except in full, without prior written approval of the Company. Any unauthorized alteration, forgery or falsification of the content or appearance of this document is unlawful and offenders may be prosecuted to the fullest extent of the law. Unless otherwise stated the results shown in this test report refer only to the sample(s) tested.



測試報告

Test Report

號碼(No.) : CE/2017/95671

日期(Date) : 2017/10/06

頁數(Page): 6 of 16

西北臺慶科技股份有限公司 / TAI-TECH ADVANCED ELECTRONICS CO., LTD.

(臺慶精密電子(昆山)有限公司 / TAI-TECH ADVANCED ELECTRONICS (KUN-SHAN) CO. LTD.)

(慶邦電子元器件(泗洪)有限公司 / TAIPAQ ELECTRONICS (SI-HONG) CO., LTD.)

桃園市楊梅區幼獅工業區幼四路1號 / NO. 1, YOU 4TH ROAD, YOUTH INDUSTRIAL DISTRICT, YANG-MEI, TAO-YUAN CITY, TAIWAN, R. O. C.

(江蘇省昆山市蓬閘昆嘉高科技工業區郭澤路 / GUO-ZE ROAD, KUNJIA HI-TECH INDUSTRIAL PARK, KUN-SHAN, JIANG-SU, CHINA)

(中國, 江蘇省, 宿遷市, 泗洪縣, 經濟開發區杭州路南側, 建設北路東側 / THE SOUTH HANGZHOU ROAD AND THE EAST JIANSHE ROAD, ECONOMIC DEVELOPMENT ZONE, SIHONG COUNTY, SUQIANCITY, JIANGSU PROVINCE, P, R, CHINA)



測試項目 (Test Items)	單位 (Unit)	測試方法 (Method)	方法偵測 極限值 (MDL)	結果 (Result)
				No. 1
鹵素 / Halogen				
鹵素 (氟) / Halogen-Fluorine (F) (CAS No. : 14762-94-8)	mg/kg	參考BS EN 14582 (2016), 以離子層析儀分析. / With reference to BS EN 14582 (2016). Analysis was performed by IC.	50	n. d.
鹵素 (氯) / Halogen-Chlorine (Cl) (CAS No. : 22537-15-1)	mg/kg		50	n. d.
鹵素 (溴) / Halogen-Bromine (Br) (CAS No. : 10097-32-2)	mg/kg		50	n. d.
鹵素 (碘) / Halogen-Iodine (I) (CAS No. : 14362-44-8)	mg/kg		50	n. d.

備註(Note) :

1. mg/kg = ppm ; 0.1wt% = 1000ppm
2. n. d. = Not Detected (未檢出)
3. MDL = Method Detection Limit (方法偵測極限值)
4. "-" = Not Regulated (無規格值)
5. **= Qualitative analysis (No Unit) 定性分析(無單位)
6. Negative = Undetectable 陰性(未偵測到); Positive = Detectable 陽性(已偵測到)
7. (◆) :

若鉻含量小於六價鉻之方法偵測極限值, 則六價鉻為n. d., 不須再測試六價鉻。

The result of Cr(VI) is "n. d." as the result of Chromium (Cr) is less than the MDL of Cr(VI), and confirmation test of Cr(VI) is not required.

若鉻含量未小於六價鉻之方法偵測極限值, 需進行六價鉻測試。

If the Chromium (Cr) content is not less than the MDL of Cr(VI), confirmation test of Cr(VI) is required.

This document is issued by the Company subject to its General Conditions of Service printed overleaf, available on request or accessible at <http://www.sgs.com/en/Terms-and-Conditions.aspx> and, for electronic format documents, subject to Terms and Conditions for Electronic Documents at <http://www.sgs.com/en/Electronic-Documents.aspx>. Attention is drawn to the limitation of liability, indemnification and jurisdiction issues defined therein. Any holder of this document is advised that information contained hereon reflects the Company's findings at the time of its intervention only and within the limits of client's instruction, if any. The Company's sole responsibility is to its Client and this document does not exonerate parties to a transaction from exercising all their rights and obligations under the transaction documents. This document cannot be reproduced, except in full, without prior written approval of the Company. Any unauthorized alteration, forgery or falsification of the content or appearance of this document is unlawful and offenders may be prosecuted to the fullest extent of the law. Unless otherwise stated the results shown in this test report refer only to the sample(s) tested.



測試報告

Test Report

號碼(No.) : CE/2017/95671

日期(Date) : 2017/10/06

頁數(Page): 7 of 16

西北臺慶科技股份有限公司 / TAI-TECH ADVANCED ELECTRONICS CO., LTD.



(臺慶精密電子(昆山)有限公司 / TAI-TECH ADVANCED ELECTRONICS (KUN-SHAN) CO. LTD.)

(慶邦電子元器件(泗洪)有限公司 / TAIPAQ ELECTRONICS (SI-HONG) CO., LTD.)

桃園市楊梅區幼獅工業區幼四路1號 / NO. 1, YOU 4TH ROAD, YOUTH INDUSTRIAL DISTRICT, YANG-MEI, TAO-YUAN CITY, TAIWAN, R. O. C.

(江蘇省昆山市蓬朗昆嘉高科技工業區郭澤路 / GUO-ZE ROAD, KUNJIA HI-TECH INDUSTRIAL PARK, KUN-SHAN, JIANG-SU, CHINA)

(中國, 江蘇省, 宿遷市, 泗洪縣, 經濟開發區杭州路南側, 建設北路東側 / THE SOUTH HANGZHOU ROAD AND THE EAST JIANSHE ROAD, ECONOMIC DEVELOPMENT ZONE, SIHONG COUNTY, SUQIANCITY, JIANGSU PROVINCE, P, R, CHINA)

8. 樣品的測試是基於申請人要求混合測試, 報告中的混合測試結果不代表其中個別單一材質的含量. (The samples was/were analyzed on behalf of the applicant as mixing sample in one testing. The above results was/were only given as the informality value.)

This document is issued by the Company subject to its General Conditions of Service printed overleaf, available on request or accessible at <http://www.sgs.com/en/Terms-and-Conditions.aspx> and, for electronic format documents, subject to Terms and Conditions for Electronic Documents at <http://www.sgs.com/en/Forms-and-Conditions/English/Document.aspx>. Attention is drawn to the limitation of liability, indemnification and jurisdiction issues defined therein. Any holder of this document is advised that information contained hereon reflects the Company's findings at the time of its intervention only and within the limits of client's instruction, if any. The Company's sole responsibility is to its Client and this document does not exonerate parties to a transaction from exercising all their rights and obligations under the transaction documents. This document cannot be reproduced, except in full, without prior written approval of the Company. Any unauthorized alteration, forgery or falsification of the content or appearance of this document is unlawful and offenders may be prosecuted to the fullest extent of the law. Unless otherwise stated the results shown in this test report refer only to the sample(s) tested.

測試報告 Test Report

號碼(No.) : CE/2017/95671

日期(Date) : 2017/10/06

頁數(Page): 8 of 16

西北臺慶科技股份有限公司 / TAI-TECH ADVANCED ELECTRONICS CO., LTD.

(臺慶精密電子(昆山)有限公司 / TAI-TECH ADVANCED ELECTRONICS (KUN-SHAN) CO. LTD.)

(慶邦電子元器件(泗洪)有限公司 / TAIPAQ ELECTRONICS (SI-HONG) CO., LTD.)

桃園市楊梅區幼獅工業區幼四路1號 / NO. 1, YOU 4TH ROAD, YOUTH INDUSTRIAL DISTRICT, YANG-MEI, TAO-YUAN CITY, TAIWAN, R. O. C.

(江蘇省昆山市蓬朗昆嘉高科技工業區郭澤路 / GUO-ZE ROAD, KUNJIA HI-TECH INDUSTRIAL PARK, KUN-SHAN, JIANG-SU, CHINA)

(中國, 江蘇省, 宿遷市, 泗洪縣, 經濟開發區杭州路南側, 建設北路東側 / THE SOUTH HANGZHOU ROAD AND THE EAST JIANSHE ROAD, ECONOMIC DEVELOPMENT ZONE, SIHONG COUNTY, SUQIANCITY, JIANGSU PROVINCE, P, R, CHINA)

重金屬流程圖 / Analytical flow chart of Heavy Metal

根據以下的流程圖之條件, 樣品已完全溶解。(六價鉻測試方法除外)

These samples were dissolved totally by pre-conditioning method according to below flow chart. (Cr⁶⁺ test method excluded)

- 測試人員: 王志璋 / Technician: JR Wang
- 測試負責人: 張啟興 / Supervisor: Troy Chang

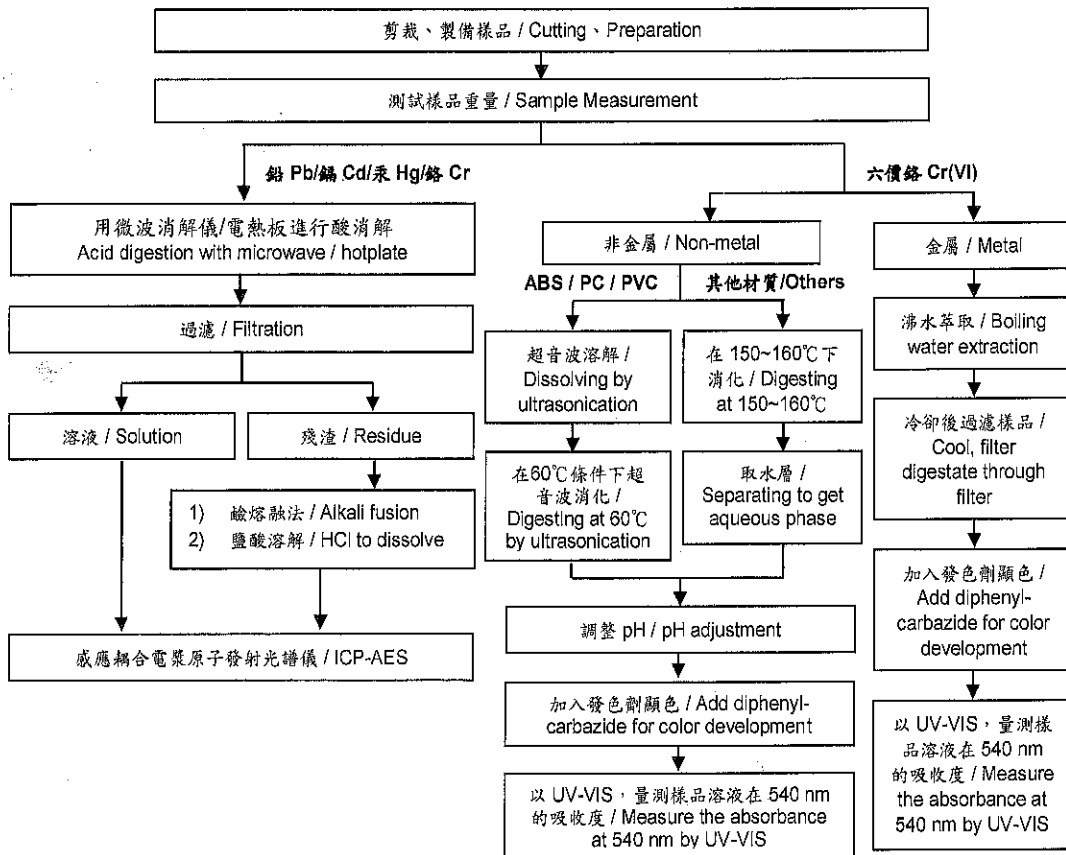

This document is issued by the Company subject to its General Conditions of Service printed overleaf, available on request or accessible at <http://www.sgs.com.tw/Terms-and-Conditions.aspx> and, for electronic format documents, subject to Terms and Conditions for Electronic Documents at <http://www.sgs.com.tw/Terms-and-Conditions.aspx>. Attention is drawn to the limitation of liability, indemnification and jurisdiction issues defined therein. Any holder of this document is advised that information contained hereon reflects the Company's findings at the time of its intervention only and within the limits of client's instruction, if any. The Company's sole responsibility is to its Client and this document does not exonerate parties to a transaction from exercising all their rights and obligations under the transaction documents. This document cannot be reproduced, except in full, without prior written approval of the Company. Any unauthorized alteration, forgery or falsification of the content or appearance of this document is unlawful and offenders may be prosecuted to the fullest extent of the law. Unless otherwise stated the results shown in this test report refer only to the sample(s) tested.



測試報告 Test Report

號碼(No.) : CE/2017/95671

日期(Date) : 2017/10/06

頁數(Page): 9 of 16

西北臺慶科技股份有限公司 / TAI-TECH ADVANCED ELECTRONICS CO., LTD.



(臺慶精密電子(昆山)有限公司 / TAI-TECH ADVANCED ELECTRONICS (KUN-SHAN) CO. LTD.)

(慶邦電子元器件(泗洪)有限公司 / TAIPAQ ELECTRONICS (SI-HONG) CO., LTD.)

桃園市楊梅區幼獅工業區幼四路1號 / NO. 1, YOU 4TH ROAD, YOUTH INDUSTRIAL DISTRICT, YANG-MEI, TAO-YUAN CITY, TAIWAN, R. O. C.

(江蘇省昆山市蓬朗區嘉高科技工業區郭澤路 / GUO-ZE ROAD, KUNJIA HI-TECH INDUSTRIAL PARK, KUN-SHAN, JIANG-SU, CHINA)

(中國, 江蘇省, 宿遷市, 泗洪縣, 經濟開發區杭州路南側, 建設北路東側 / THE SOUTH HANGZHOU ROAD AND THE EAST JIANSHE ROAD, ECONOMIC DEVELOPMENT ZONE, SIHONG COUNTY, SUQIANCITY, JIANGSU PROVINCE, P, R, CHINA)

根據以下的流程圖之條件, 樣品已完全溶解。 / These samples were dissolved totally by pre-conditioning method according to below flow chart.

- 測試人員: 王志璋 / Technician: JR Wang
- 測試負責人: 張啟興 / Supervisor: Troy Chang

元素以 ICP-AES 分析的消化流程圖
(Flow Chart of digestion for the elements analysis performed by ICP-AES)

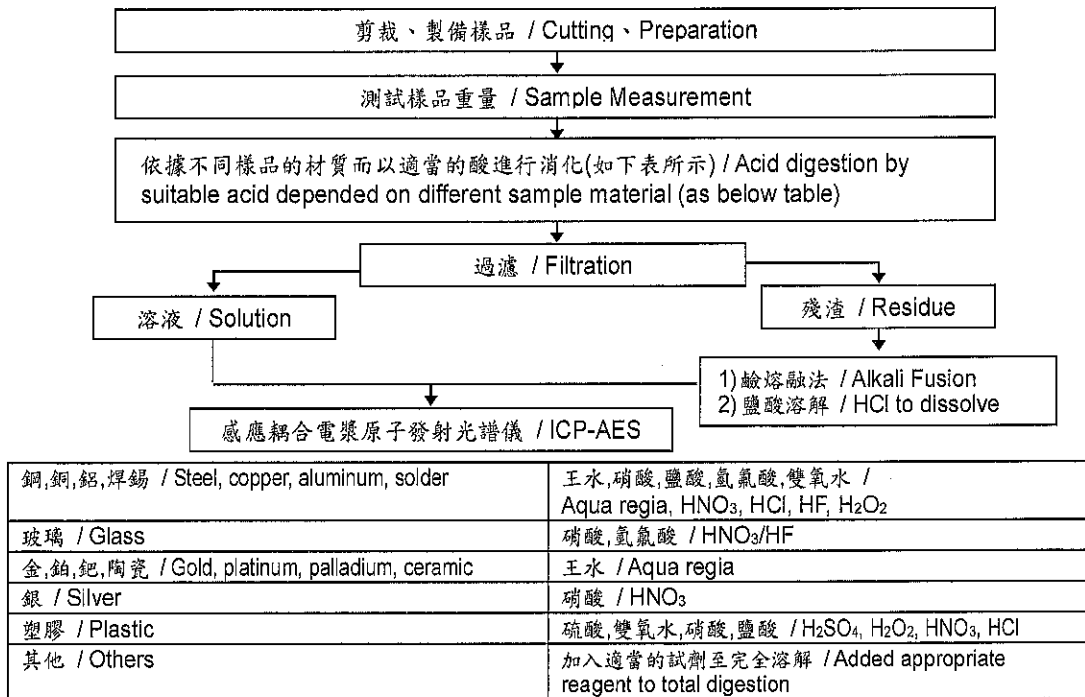

This document is issued by the Company subject to its General Conditions of Service printed over/leaf, available on request or accessible at <http://www.sgs.com/for/terms-and-conditions.aspx> and, for electronic format documents, subject to Terms and Conditions for Electronic Documents at <http://www.sgs.com/for/terms-and-conditions-electronic-document.aspx>. Attention is drawn to the limitation of liability, indemnification and jurisdiction issues defined therein. Any holder of this document is advised that information contained hereon reflects the Company's findings at the time of its intervention only and within the limits of client's instruction, if any. The Company's sole responsibility is to its Client and this document does not exonerate parties to a transaction from exercising all their rights and obligations under the transaction documents. This document cannot be reproduced, except in full, without prior written approval of the Company. Any unauthorized alteration, forgery or falsification of the content or appearance of this document is unlawful and offenders may be prosecuted to the fullest extent of the law. Unless otherwise stated the results shown in this test report refer only to the sample(s) tested.



測試報告 Test Report

號碼(No.) : CE/2017/95671

日期(Date) : 2017/10/06

頁數(Page): 10 of 16

西北臺慶科技股份有限公司 / TAI-TECH ADVANCED ELECTRONICS CO., LTD.

(臺慶精密電子(昆山)有限公司 / TAI-TECH ADVANCED ELECTRONICS (KUN-SHAN) CO. LTD.)

(慶邦電子元器件(泗洪)有限公司 / TAIPAQ ELECTRONICS (SI-HONG) CO., LTD.)

桃園市楊梅區幼獅工業區幼四路1號 / NO. 1, YOU 4TH ROAD, YOUTH INDUSTRIAL DISTRICT, YANG-MEI, TAO-YUAN CITY, TAIWAN, R. O. C.

(江蘇省昆山市蓬朗昆嘉高科技工業區郭澤路 / GUO-ZE ROAD, KUNJIA HI-TECH INDUSTRIAL PARK, KUN-SHAN, JIANG-SU, CHINA)

(中國, 江蘇省, 宿遷市, 泗洪縣, 經濟開發區杭州路南側, 建設北路東側 / THE SOUTH HANGZHOU ROAD AND THE EAST JIANSHE ROAD, ECONOMIC DEVELOPMENT ZONE, SIHONG COUNTY, SUQIANCITY, JIANGSU PROVINCE, P, R, CHINA)



全氟辛酸/全氟辛烷磺酸分析流程圖 / Analytical flow chart - PFOA/PFOS

- 測試人員: 涂雅苓 / Technician: Yaling Tu
- 測試負責人: 張啟興 / Supervisor: Troy Chang

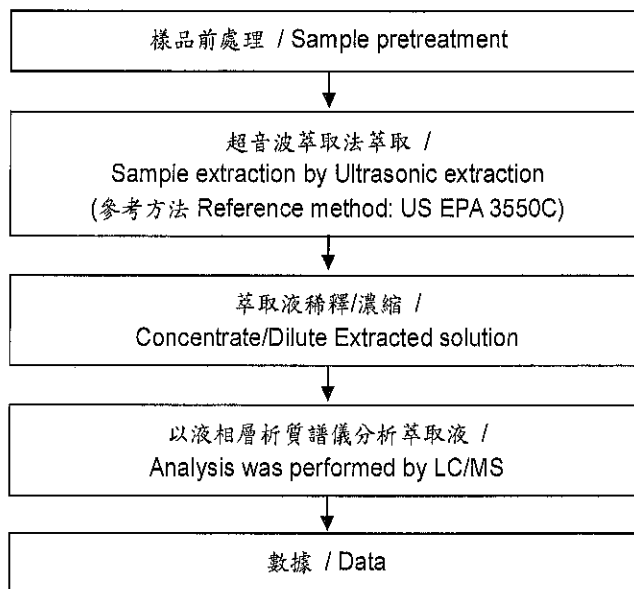

This document is issued by the Company subject to its General Conditions of Service printed overleaf, available on request or accessible at <http://www.sgs.com/en/Terms-and-Conditions.aspx> and, for electronic format documents, subject to Terms and Conditions for Electronic Documents at <http://www.sgs.com/en/Terms-and-Conditions-for-Electronic-Documents.aspx>. Attention is drawn to the limitation of liability, indemnification and jurisdiction issues defined therein. Any holder of this document is advised that information contained herein reflects the Company's findings at the time of its intervention only and within the limits of client's instruction, if any. The Company's sole responsibility is to its Client and this document does not exonerate parties to a transaction from exercising all their rights and obligations under the transaction documents. This document cannot be reproduced, except in full, without prior written approval of the Company. Any unauthorized alteration, forgery or falsification of the content or appearance of this document is unlawful and offenders may be prosecuted to the fullest extent of the law. Unless otherwise stated the results shown in this test report refer only to the sample(s) tested.



測試報告

Test Report

號碼(No.) : CE/2017/95671

日期(Date) : 2017/10/06

頁數(Page): 11 of 16

西北臺慶科技股份有限公司 / TAI-TECH ADVANCED ELECTRONICS CO., LTD.



(臺慶精密電子(昆山)有限公司 / TAI-TECH ADVANCED ELECTRONICS (KUN-SHAN) CO. LTD.)

(慶邦電子元器件(泗洪)有限公司 / TAIPAQ ELECTRONICS (SI-HONG) CO., LTD.)

桃園市楊梅區幼獅工業區幼四路1號 / NO. 1, YOU 4TH ROAD, YOUTH INDUSTRIAL DISTRICT, YANG-MEI, TAO-YUAN CITY, TAIWAN, R. O. C.

(江蘇省昆山市蓬朗鎮嘉高科技工業區郭澤路 / GUO-ZE ROAD, KUNJIA HI-TECH INDUSTRIAL PARK, KUN-SHAN, JIANG-SU, CHINA)

(中國, 江蘇省, 宿遷市, 泗洪縣, 經濟開發區杭州路南側, 建設北路東側 / THE SOUTH HANGZHOU ROAD AND THE EAST JIANSHE ROAD, ECONOMIC DEVELOPMENT ZONE, SIHONG COUNTY, SUQIANCITY, JIANGSU PROVINCE, P, R, CHINA)

聚氯乙稀物質判定分析流程圖 / Analysis flow chart - PVC

- 測試人員: 涂雅苓 / Technician: Yaling Tu
- 測試負責人: 張啟興 / Supervisor: Troy Chang

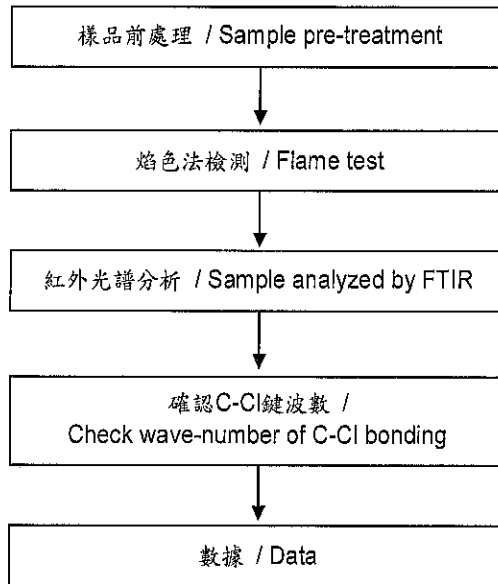

This document is issued by the Company subject to its General Conditions of Service printed overleaf, available on request or accessible at <http://www.sgs.com/en/Terms-and-Conditions.aspx> and, for electronic format documents, subject to Terms and Conditions for Electronic Documents at <http://www.sgs.com/en/Terms-and-Conditions-for-Electronic-Documents.aspx>. Attention is drawn to the limitation of liability, indemnification and jurisdiction issues defined therein. Any holder of this document is advised that information contained hereon reflects the Company's findings at the time of its intervention only and within the limits of client's instruction, if any. The Company's sole responsibility is to its Client and this document does not exonerate parties to a transaction from exercising all their rights and obligations under the transaction documents. This document cannot be reproduced, except in full, without prior written approval of the Company. Any unauthorized alteration, forgery or falsification of the content or appearance of this document is unlawful and offenders may be prosecuted to the fullest extent of the law. Unless otherwise stated the results shown in this test report refer only to the sample(s) tested.



測試報告 Test Report

號碼(No.) : CE/2017/95671

日期(Date) : 2017/10/06

頁數(Page): 12 of 16

西北臺慶科技股份有限公司 / TAI-TECH ADVANCED ELECTRONICS CO., LTD.

(臺慶精密電子(昆山)有限公司 / TAI-TECH ADVANCED ELECTRONICS (KUN-SHAN) CO. LTD.)

(慶邦電子元器件(泗洪)有限公司 / TAIPAQ ELECTRONICS (SI-HONG) CO., LTD.)

桃園市楊梅區幼獅工業區幼四路1號 / NO. 1, YOU 4TH ROAD, YOUTH INDUSTRIAL DISTRICT, YANG-MEI, TAO-YUAN CITY, TAIWAN, R. O. C.

(江蘇省昆山市蓬朗昆嘉高科技工業區郭澤路 / GUO-ZE ROAD, KUNJIA HI-TECH INDUSTRIAL PARK, KUN-SHAN, JIANG-SU, CHINA)

(中國, 江蘇省, 宿遷市, 泗洪縣, 經濟開發區杭州路南側, 建設北路東側 / THE SOUTH HANGZHOU ROAD AND THE EAST JIANSHE ROAD, ECONOMIC DEVELOPMENT ZONE, SIHONG COUNTY, SUQIANCITY, JIANGSU PROVINCE, P, R, CHINA)

六溴環十二烷分析流程圖 / Analytical flow chart - HBCDD

- 測試人員: 涂雅苓 / Technician: Yaling Tu
- 測試負責人: 張啟興 / Supervisor: Troy Chang

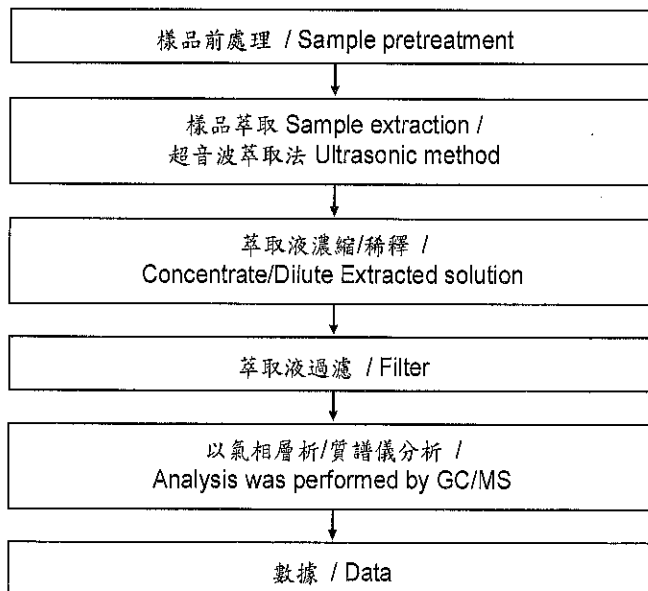

This document is issued by the Company subject to its General Conditions of Service printed overleaf, available on request or accessible at http://www.sgs.com/ce/Terms_and_Conditions.aspx and, for electronic format documents, subject to Terms and Conditions for Electronic Documents at http://www.sgs.com/en/Terms_and_Conditions/English_Document.aspx. Attention is drawn to the limitation of liability, indemnification and jurisdiction issues defined therein. Any holder of this document is advised that information contained hereon reflects the Company's findings at the time of its intervention only and within the limits of client's instruction, if any. The Company's sole responsibility is to its Client and this document does not exonerate parties to a transaction from exercising all their rights and obligations under the transaction documents. This document cannot be reproduced, except in full, without prior written approval of the Company. Any unauthorized alteration, forgery or falsification of the content or appearance of this document is unlawful and offenders may be prosecuted to the fullest extent of the law. Unless otherwise stated the results shown in this test report refer only to the sample(s) tested.



測試報告

Test Report

號碼(No.) : CE/2017/95671

日期(Date) : 2017/10/06

頁數(Page): 13 of 16

西北臺慶科技股份有限公司 / TAI-TECH ADVANCED ELECTRONICS CO., LTD.



(臺慶精密電子(昆山)有限公司 / TAI-TECH ADVANCED ELECTRONICS (KUN-SHAN) CO. LTD.)

(慶邦電子元器件(泗洪)有限公司 / TAIPAQ ELECTRONICS (SI-HONG) CO., LTD.)

桃園市楊梅區幼獅工業區幼四路1號 / NO. 1, YOU 4TH ROAD, YOUTH INDUSTRIAL DISTRICT, YANG-MEI, TAO-YUAN CITY, TAIWAN, R. O. C.

(江蘇省昆山市蓬朗昆嘉高科技工業區郭澤路 / GUO-ZE ROAD, KUNJIA HI-TECH INDUSTRIAL PARK, KUN-SHAN, JIANG-SU, CHINA)

(中國, 江蘇省, 宿遷市, 泗洪縣, 經濟開發區杭州路南側, 建設北路東側 / THE SOUTH HANGZHOU ROAD AND THE EAST JIANSHE ROAD, ECONOMIC DEVELOPMENT ZONE, SIHONG COUNTY, SUQIANCITY, JIANGSU PROVINCE, P, R, CHINA)

可塑劑分析流程圖 / Analytical flow chart - Phthalate

- 測試人員: 徐毓明 / Technician: Andy Hsu
- 測試負責人: 張啟興 / Supervisor: Troy Chang

【測試方法/Test method: IEC 62321-8】

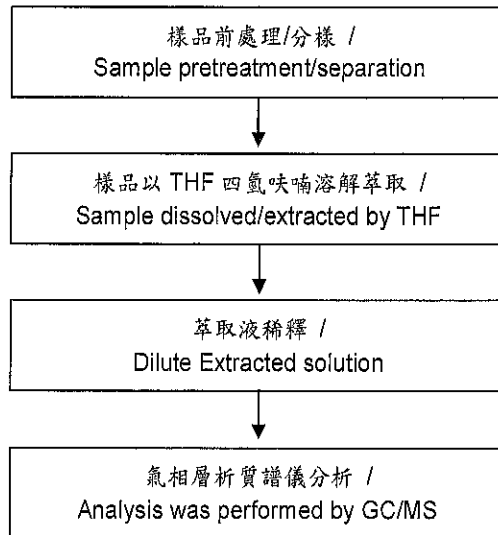

This document is issued by the Company subject to its General Conditions of Service printed overleaf, available on request or accessible at <http://www.sgs.com/en/Terms-and-Conditions.aspx> and, for electronic format documents, subject to Terms and Conditions for Electronic Documents at <http://www.sgs.com/en/Terms-and-Conditions-for-Electronic-Documents.aspx>. Attention is drawn to the limitation of liability, indemnification and jurisdiction issues defined therein. Any holder of this document is advised that information contained hereon reflects the Company's findings at the time of its intervention only and within the limits of client's instruction, if any. The Company's sole responsibility is to its Client and this document does not exonerate parties to a transaction from exercising all their rights and obligations under the transaction documents. This document cannot be reproduced, except in full, without prior written approval of the Company. Any unauthorized alteration, forgery or falsification of the content or appearance of this document is unlawful and offenders may be prosecuted to the fullest extent of the law. Unless otherwise stated the results shown in this test report refer only to the sample(s) tested.

測試報告 Test Report

號碼(No.) : CE/2017/95671

日期(Date) : 2017/10/06

頁數(Page): 14 of 16

西北臺慶科技股份有限公司 / TAI-TECH ADVANCED ELECTRONICS CO., LTD.

(臺慶精密電子(昆山)有限公司 / TAI-TECH ADVANCED ELECTRONICS (KUN-SHAN) CO. LTD.)

(慶邦電子元器件(泗洪)有限公司 / TAIPAQ ELECTRONICS (SI-HONG) CO., LTD.)

桃園市楊梅區幼獅工業區幼四路1號 / NO. 1, YOU 4TH ROAD, YOUTH INDUSTRIAL DISTRICT, YANG-MEI, TAO-YUAN CITY, TAIWAN, R. O. C.

(江蘇省昆山市蓬閱昆嘉高科技工業區郭澤路 / GUO-ZE ROAD, KUNJIA HI-TECH INDUSTRIAL PARK, KUN-SHAN, JIANG-SU, CHINA)

(中國, 江蘇省, 宿遷市, 泗洪縣, 經濟開發區杭州路南側, 建設北路東側 / THE SOUTH HANGZHOU ROAD AND THE EAST JIANSHE ROAD, ECONOMIC DEVELOPMENT ZONE, SIHONG COUNTY, SUQIANCITY, JIANGSU PROVINCE, P, R, CHINA)



多溴聯苯/多溴聯苯醚分析流程圖 / Analytical flow chart - PBB/PBDE

- 測試人員: 涂雅琴 / Technician: Yaling Tu
- 測試負責人: 張啟興 / Supervisor: Troy Chang

初次測試程序 / First testing process →
選擇性篩檢程序 / Optional screen process
確認程序 / Confirmation process - - - →

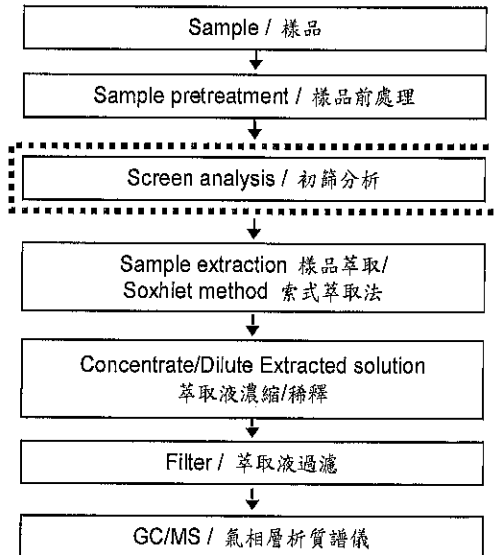

This document is issued by the Company subject to its General Conditions of Service printed overleaf, available on request or accessible at <http://www.sgs.com.tw/Terms-and-Conditions.aspx> and, for electronic format documents, subject to Terms and Conditions for Electronic Documents at <http://www.sgs.com.tw/Terms-and-Conditions/Terms-Document.aspx>. Attention is drawn to the limitation of liability, indemnification and jurisdiction issues defined therein. Any holder of this document is advised that information contained hereon reflects the Company's findings at the time of its intervention only and within the limits of client's instruction, if any. The Company's sole responsibility is to its Client and this document does not exonerate parties to a transaction from exercising all their rights and obligations under the transaction documents. This document cannot be reproduced, except in full, without prior written approval of the Company. Any unauthorized alteration, forgery or falsification of the content or appearance of this document is unlawful and offenders may be prosecuted to the fullest extent of the law. Unless otherwise stated the results shown in this test report refer only to the sample(s) tested.



測試報告

Test Report

號碼(No.) : CE/2017/95671

日期(Date) : 2017/10/06

頁數(Page): 15 of 16

西北臺慶科技股份有限公司 / TAI-TECH ADVANCED ELECTRONICS CO., LTD.

(臺慶精密電子(昆山)有限公司 / TAI-TECH ADVANCED ELECTRONICS (KUN-SHAN) CO. LTD.)

(慶邦電子元器件(泗洪)有限公司 / TAIPAQ ELECTRONICS (SI-HONG) CO., LTD.)

桃園市楊梅區幼獅工業區幼四路1號 / NO. 1, YOU 4TH ROAD, YOUTH INDUSTRIAL DISTRICT, YANG-MEI, TAO-YUAN CITY, TAIWAN, R. O. C.

(江蘇省昆山市蓬朗昆嘉高科技工業區郭澤路 / GUO-ZE ROAD, KUNJIA HI-TECH INDUSTRIAL PARK, KUN-SHAN, JIANG-SU, CHINA)

(中國, 江蘇省, 宿遷市, 泗洪縣, 經濟開發區杭州路南側, 建設北路東側 / THE SOUTH HANGZHOU ROAD AND THE EAST JIANSHE ROAD, ECONOMIC DEVELOPMENT ZONE, SIHONG COUNTY, SUQIANCITY, JIANGSU PROVINCE, P, R, CHINA)

鹵素分析流程圖 / Analytical flow chart - Halogen

- 測試人員: 陳恩臻 / Technician: Rita Chen
- 測試負責人: 張啟興 / Supervisor: Troy Chang

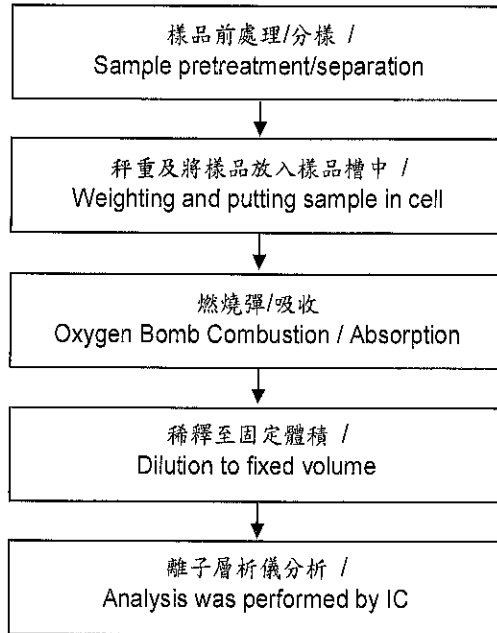

This document is issued by the Company subject to its General Conditions of Service printed overleaf, available on request or accessible at <http://www.sgs.com/any/Terms-and-Conditions.aspx> and, for electronic format documents, subject to Terms and Conditions for Electronic Documents at <http://www.sgs.com/any/Terms-and-Conditions.aspx>. Attention is drawn to the limitation of liability, indemnification and jurisdiction issues defined therein. Any holder of this document is advised that information contained hereon reflects the Company's findings at the time of its intervention only and within the limits of client's instruction, if any. The Company's sole responsibility is to its Client and this document does not exonerate parties to a transaction from exercising all their rights and obligations under the transaction documents. This document cannot be reproduced, except in full, without prior written approval of the Company. Any unauthorized alteration, forgery or falsification of the content or appearance of this document is unlawful and offenders may be prosecuted to the fullest extent of the law. Unless otherwise stated the results shown in this test report refer only to the sample(s) tested.

測試報告

Test Report

號碼(No.) : CE/2017/95671

日期(Date) : 2017/10/06

頁數(Page): 16 of 16

西北臺慶科技股份有限公司 / TAI-TECH ADVANCED ELECTRONICS CO., LTD.

(臺慶精密電子(昆山)有限公司 / TAI-TECH ADVANCED ELECTRONICS (KUN-SHAN) CO. LTD.)

(慶邦電子元器件(泗洪)有限公司 / TAIPAQ ELECTRONICS (SI-HONG) CO., LTD.)

桃園市楊梅區幼獅工業區幼四路1號 / NO. 1, YOU 4TH ROAD, YOUTH INDUSTRIAL DISTRICT, YANG-MEI, TAO-YUAN CITY, TAIWAN, R. O. C.

(江蘇省昆山市蓬朗昆嘉高科技工業區郭澤路 / GUO-ZE ROAD, KUNJIA HI-TECH INDUSTRIAL PARK, KUN-SHAN, JIANG-SU, CHINA)

(中國, 江蘇省, 宿遷市, 泗洪縣, 經濟開發區杭州路南側, 建設北路東側 / THE SOUTH HANGZHOU ROAD AND THE EAST JIANSHE ROAD, ECONOMIC DEVELOPMENT ZONE, SIHONG COUNTY, SUQIANCITY, JIANGSU PROVINCE, P, R, CHINA)

* 照片中如有箭頭標示, 則表示為實際檢測之樣品/部位. *

(The tested sample / part is marked by an arrow if it's shown on the photo.)

CE/2017/95671

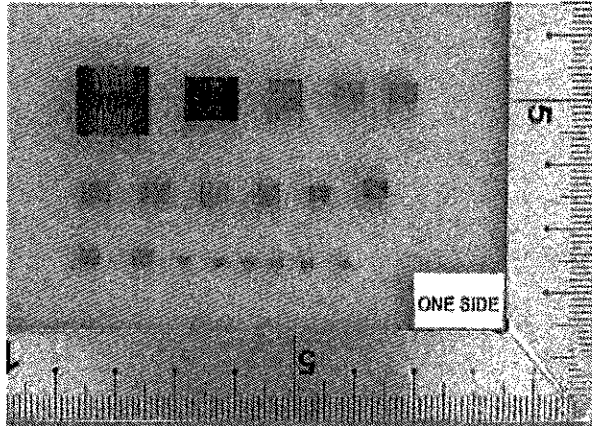

CE/2017/95671

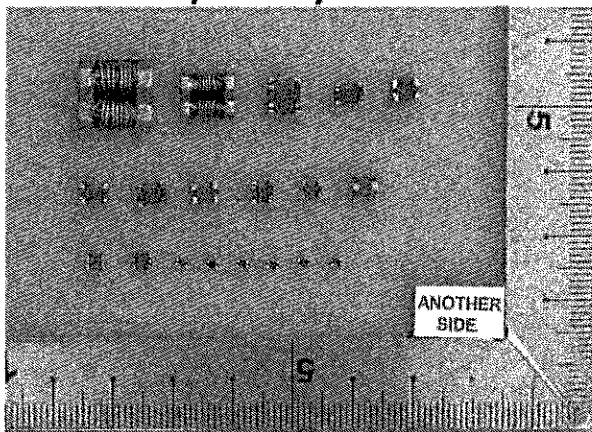

** 報告結尾 (End of Report) **

This document is issued by the Company subject to its General Conditions of Service printed overleaf, available on request or accessible at <http://www.sgs.com/sgs/Terms-and-Conditions.aspx> and, for electronic format documents, subject to Terms and Conditions for Electronic Documents at <http://www.sgs.com/sgs/Terms-and-Conditions-for-Electronic-Document.aspx>. Attention is drawn to the limitation of liability, indemnification and jurisdiction issues defined therein. Any holder of this document is advised that information contained hereon reflects the Company's findings at the time of its intervention only and within the limits of client's instruction, if any. The Company's sole responsibility is to its Client and this document does not exonerate parties to a transaction from exercising all their rights and obligations under the transaction documents. This document cannot be reproduced, except in full, without prior written approval of the Company. Any unauthorized alteration, forgery or falsification of the content or appearance of this document is unlawful and offenders may be prosecuted to the fullest extent of the law. Unless otherwise stated the results shown in this test report refer only to the sample(s) tested.