

Halogen Free

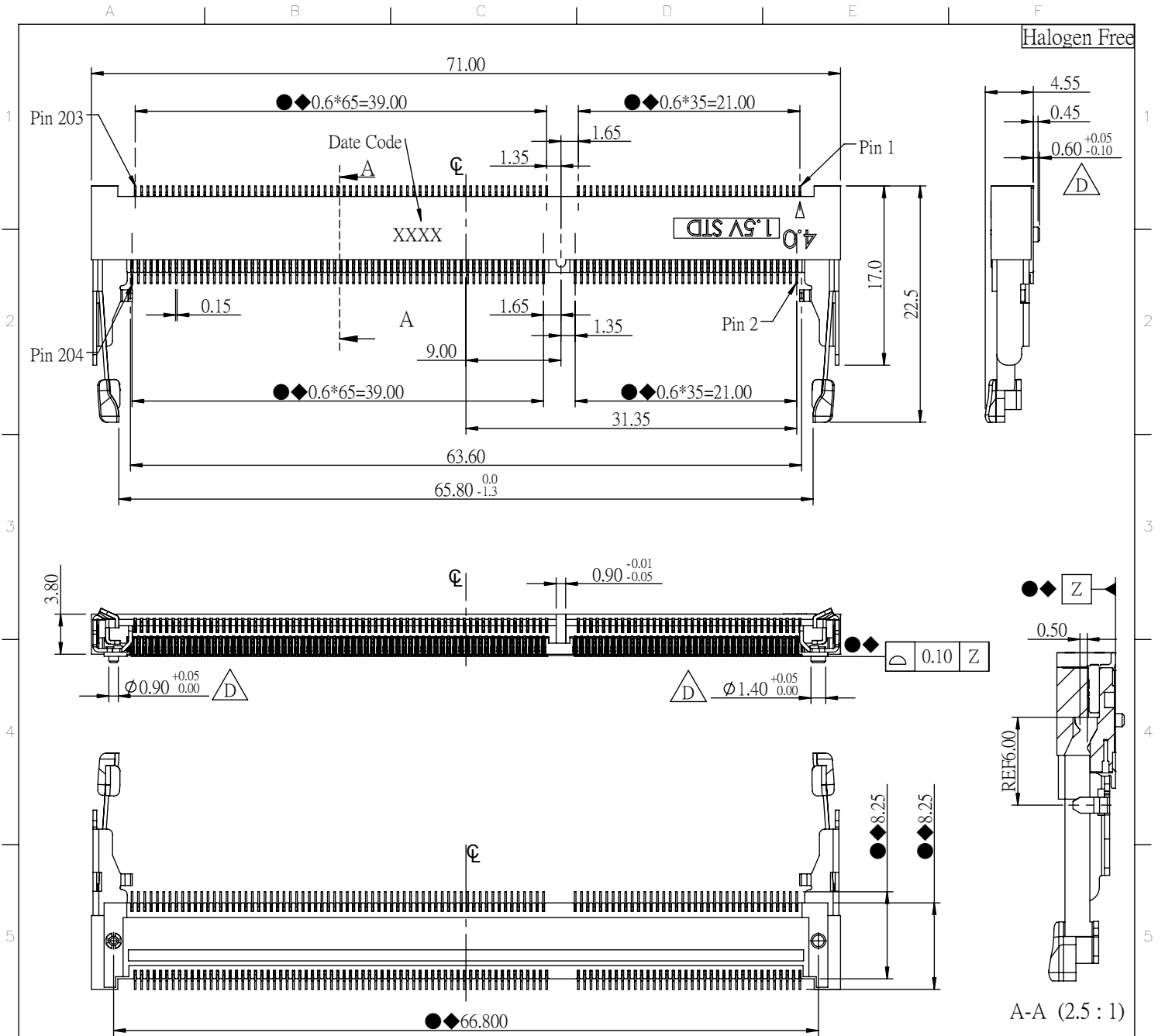

NOTE:

1. SOLDER TAIL TO BE WITHIN 0.05 UPWARD AND 0.2 DOWNWARD FROM Z-DATUM PLACE, AND COPLANARITY OF SOLDER TAILS TO BE WITHIN 0.10 MEASUREMENT POINT IS SOLDER TAIL TIP.
2. ACCORDING HSF CONCRRAFT LEVEL 1
3. MATERIAL:
 BASE: THERMOPLASTIC LCP, UL 94V-0, BLACK COLOR
 TERMINAL: COPPER ALLOY
 LATCH: STAINLESS STEEL
4. FINISH:
 TERMINAL: G/F ON CONTACT AREA, GOLD FLASH ON SOLDER TAIL, Ni 50u" MIN UNDERPLATING.
5. INSPECTION SYMBOL:
 ● : MANUFACTURER INSPECTION
 ◆ : Q.C INSPECTION

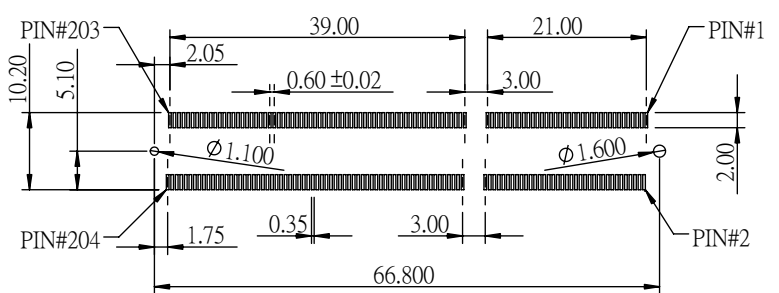

				GENERAL TOLERANCE		DRAW:	PART NO: 0705F0BE40F
				X. ±0.30	X.° ±2.00°	CHECKED:	TITLE: DDR S.O. DIMM 204P ASSEMBLY
				.X ±0.20	.X° ±1.00°		APPROVE:
D	E110576A	Flora	12/15/2011	.XX ±0.10	.XX° ±0.50°		
C	E100372A	Flora	11/22/2010	.XXX ±0.05			
8	REV.	ECO NO.	DRAW	DATE	UNITS: mm	DATE: 12/15/2011	
	MATERIAL:	FINISH:	SCALE: 1.5 : 1	SHEET: 1 / 3	REV. D		

Halogen Free

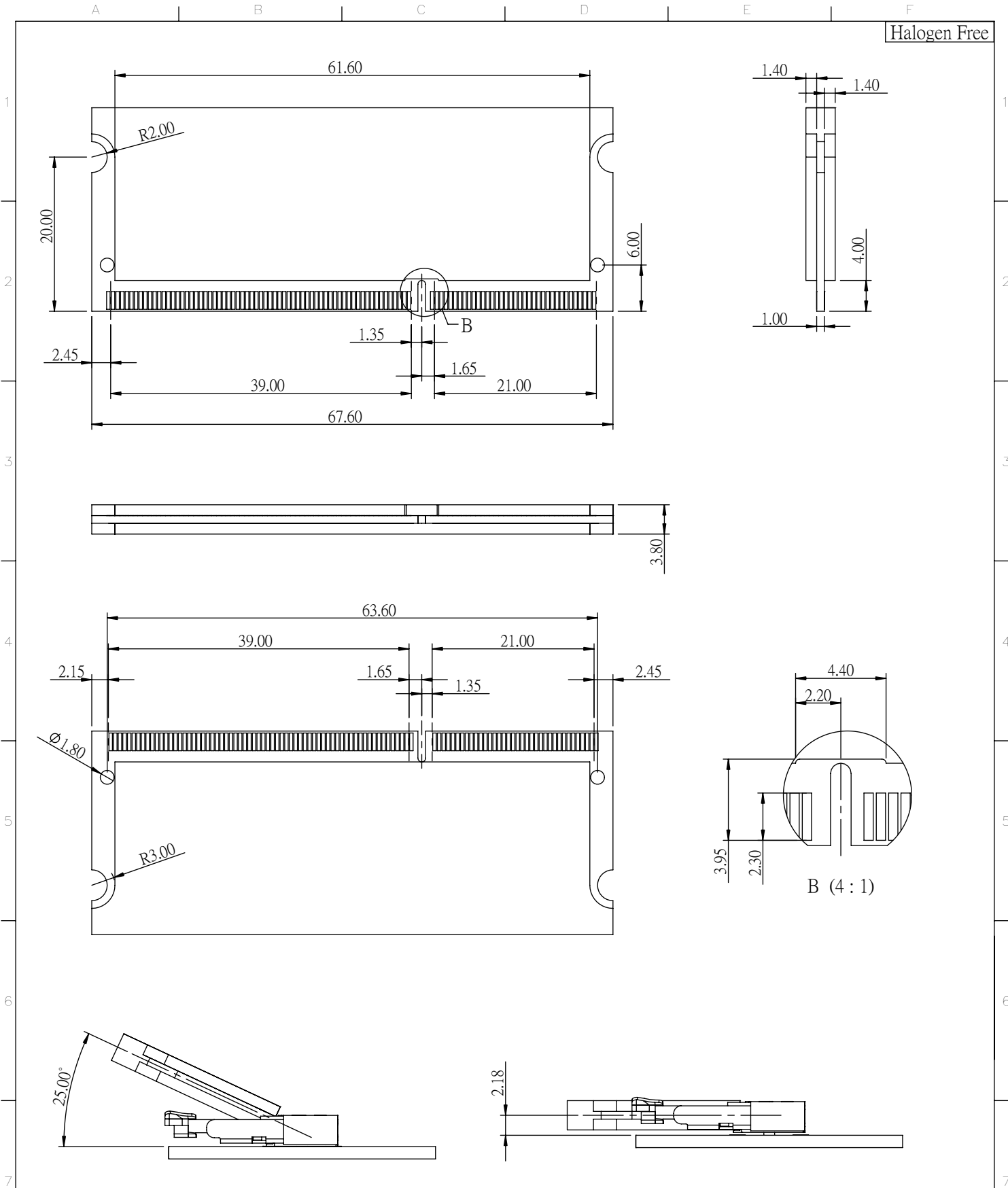

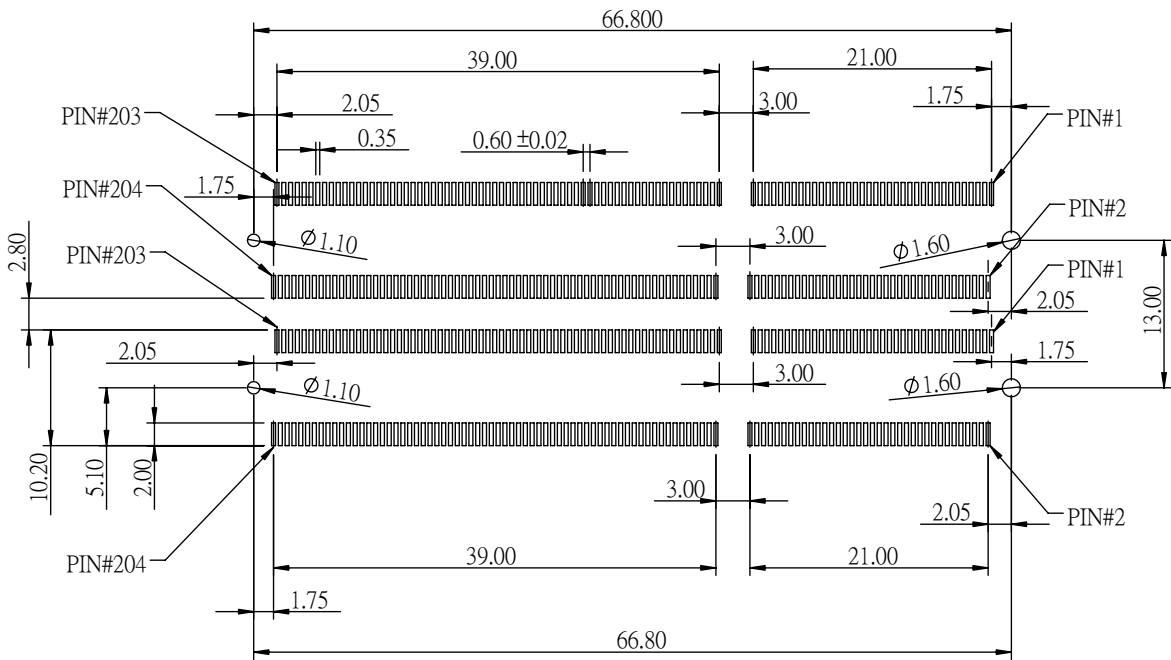
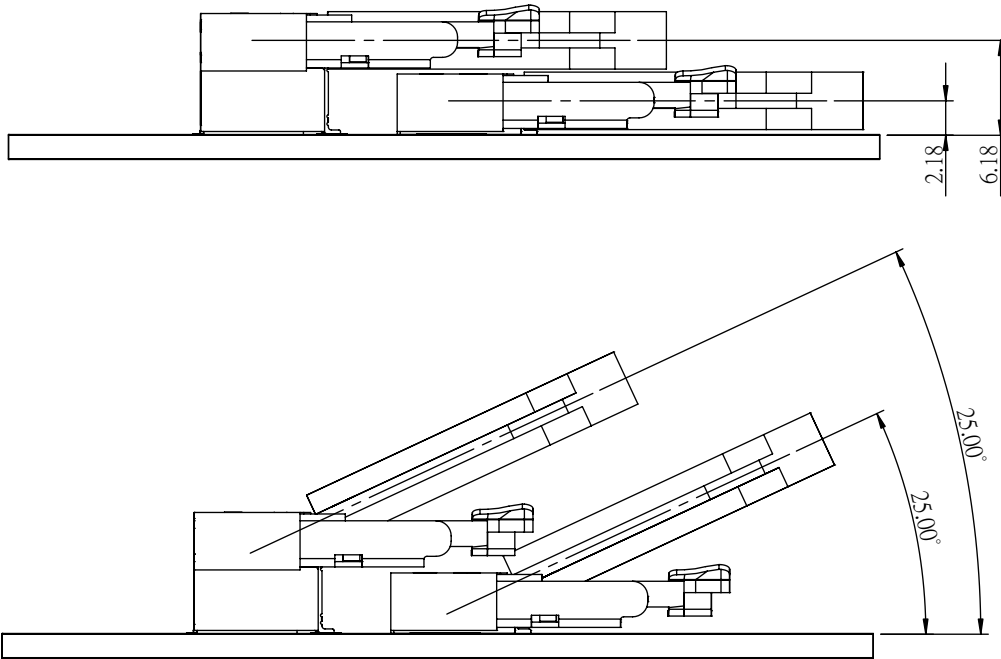

				GENERAL TOLERANCE		DRAW:	PART NO:	
				X. ±0.30	X.° ±2.00°	CHECKED:	0705F0BE40F	
				.X ±0.20	.X° ±1.00°		DRAWING NO:	0705F0BE40F
				.XX ±0.10	.XX° ±0.50°			TITLE:
D	E110576A	Flora	12/15/2011	UNITS:	DATE:	APPROVE:		
C	E100372A	Flora	11/22/2010	mm	12/15/2011			
REV.	ECO NO.	DRAW	DATE					
MATERIAL:		FINISH:	SCALE:	SHEET:	REV.			
			1.5 : 1	2 / 3	D			

DDR S.O. DIMM 204P 4.0&8.0 OVERLAY FIGURE



PCB LAYOUT : COMPONENT SIDE(4.0&8.0TYPE)

				GENERAL TOLERANCE		DRAW:	PART NO: 0705F0BE40F
				X. ±0.30	X.° ± 2.00°	CHECKED:	TITLE: DDR S.O. DIMM 204P ASSEMBLY
				.X ±0.20	.X° ± 1.00°		APPROVE:
D	E110576A	Flora	12/15/2011	.XX ±0.10	.XX° ± 0.50°		
C	E100372A	Flora	11/22/2010	UNITS: mm	DATE: 12/15/2011		
REV.	ECO NO.	DRAW	DATE				
MATERIAL:	FINISH:	SCALE: 1.5 : 1	SHEET: 3 / 3				