

Solderable with auto dipping and available in a wide variety

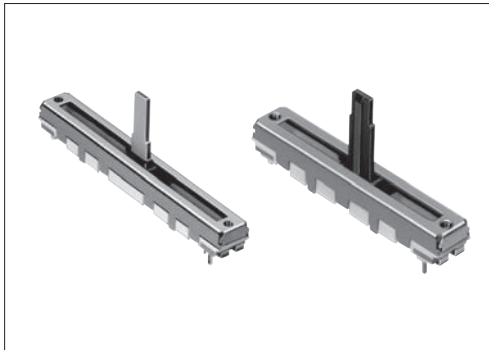

■ Typical Specifications



Items	Specifications
Total resistance tolerance	±20%
Maximum operating voltage	Please see P.407
Operating force	0.3 to 2.5N
Operating life	15,000 cycles
Operating temperature range	-25°C to +70°C

■ Product Line

Insulated lever

Number of resistor elements	Travel (mm)	Lever types	Length of lever (L1) (mm)	Total resistance (k Ω)	Resistance taper	Detent	Mounting plate	Minimum order unit (pcs.)		Products No.	Drawing No.
								Japan	Export		
Single-unit	20	J-1	5	10	1B	Without	Without	700	2,800	RS201111J011	1
	30				15A					RS301111J00P	2
					1B					RS301111AJ01R	3
					15A					RS301111J00R	2
		45	A	10	1B		Without	Without	600	2,400	RS301111AJ01K
	C										RS301111A01G
			B					RS301111AC00V			6
	RS451111ABA02							7			
Dual-unit	30	C	5	3B	With	With	1,300	1,300	RS30112AC00J	8	
		J-1							RS30112AJA02	9	

Metal lever

Number of resistor elements	Travel (mm)	Lever types	Length of lever (L1) (mm)	Total resistance (k Ω)	Resistance taper	Detent	Mounting plate	Minimum order unit (pcs.)		Products No.	Drawing No.		
								Japan	Export				
Single-unit	15	9-1	10	10	15A	Without	With	700	2,800	RS15111A900B	10		
	20				RS20111A9A03					11			
	30				4					15	20	1B	Without
		6	RS3011114A02	13									
		RS30111A602N	14										
	45	9-1	10	10	15A		Without	With	1,300	1,300	RS45111A900F	15	
											6	RS4511119A04	16
											RS6011YA600M	17	
	60	9-1	10	10	1B		Without	Without	900	900	RS6011Y19004	18	
											6	RS6011Y1600Q	19
											RS451121400A	20	
	Dual-unit	45	4	20	15A		With	With	1,150	1,150	RS45112A400G	21	
6						15					20	RS60112A600N	22
RS60112A600U													

Note

Other varieties are also available. Refer to "Other Specifications" (P.407).

Refer to P.407 for other specifications.
 Refer to P.408 for configuration details.
 Refer to P.409 for ordering products not listed.
 Refer to P.438 for soldering conditions.

■ Packing Specifications

Tray

Travel (mm)	Number of resistor elements	Number of packages (pcs.)		Export package measurements (mm)
		1 case /Japan	1 case /export packing	
15, 20	Single-unit	700	2,800	378×518×422
30	Single-unit/ Dual-unit	600	2,400	
45	Single-unit	1,300	1,300	373×529×273
	Dual-unit	1,150	1,150	
60	Single-unit/ Dual-unit	900	900	

■ Dimensions

Unit:mm

No.	Style	PC board mounting hole dimensions (Viewed from mounting side)
1		
2		
3		

The length of Lever (L₁) can be customized. Refer to P.408 for details.

■ Dimensions

Unit:mm

No.	Style	PC board mounting hole dimensions (Viewed from mounting side)
4		
5		
6		
7		
8		

The length of Lever (L₁) can be customized. Refer to P.408 for details.

Rotary Potentiometers
 Slide Potentiometers
 General-use
 Mixer

■ Dimensions

Unit:mm

No.	Style	PC board mounting hole dimensions (Viewed from mounting side)
9		
10		
11		
12		
13		

The length of Lever (L₁) can be customized. Refer to P.408 for details.

■ Dimensions

Unit:mm

No.	Style	PC board mounting hole dimensions (Viewed from mounting side)
14		
15		
16		
17		
18		

The length of Lever (L₁) can be customized. Refer to P.408 for details.

Rotary Potentiometers
 Slide Potentiometers
 General-use
 Mixer

Super Slide™ (Standard Type) / Other Specifications

In addition to the products listed, we can accommodate the follow specifications.

Travel Distance Variety

Travel (mm)	15	20	30	45	60
-------------	----	----	----	----	----

Total Resistance Variety

Total resistance (k Ω)	10	20	50	100	200
------------------------	----	----	----	-----	-----

Resistance Taper

Resistance taper	1B	3B	4B	10A	15A
------------------	----	----	----	-----	-----

Note

DC (10V DC) is also available. (Tapped types are not available)

Rated Power

Travel	Single-unit		Dual-unit	
	1B	4B, 10A, 15A	1B, 3B	4B, 10A, 15A
15mm	0.05W	0.025W	0.025W	0.012W
20mm	0.1W	0.05W	0.05W	0.025W
30mm	0.2W	0.1W	0.1W	0.05W
45mm	0.25W	0.125W	0.125W	0.06W
60mm	0.2W	0.1W	0.2W	0.1W

Maximum Operating Voltage

Travel	Single-unit		Dual-unit	
	1B	4B, 10A, 15A	1B, 3B	4B, 10A, 15A
15mm	100V AC, 10V DC	50V AC, 10V DC	100V AC, 10V DC	50V AC, 10V DC
20mm	200V AC, 10V DC	150V AC, 10V DC		
30mm				
45mm			200V AC, 10V DC	150V AC, 10V DC
60mm				

Terminal Layout / Circuit Diagram (Viewed from Mounting Side)

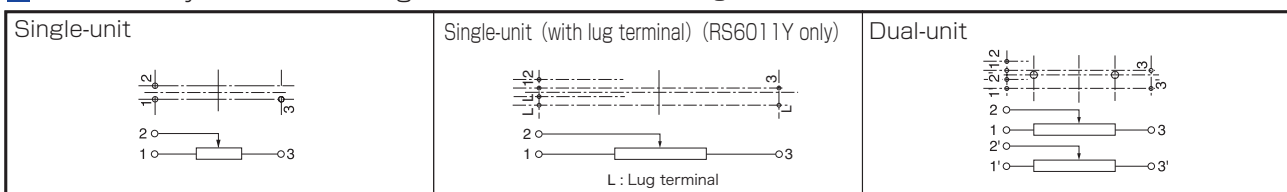

Note

Marked are specifications recommended by Alps.

In addition to the products listed, we can accommodate the follow specifications.

Lever Types

Metal lever		Insulated lever		Unit:mm					
Code	Dimensions	Code	Dimensions						
9-2	 <table border="1" style="margin-left: auto; margin-right: auto;"> <tr><td>L₁</td></tr> <tr><td>5</td></tr> </table>	L ₁	5	J-1	 <table border="1" style="margin-left: auto; margin-right: auto;"> <tr><td>L₁</td></tr> <tr><td>5</td></tr> </table>	L ₁	5		
L ₁									
5									
L ₁									
5									
9-1	 <table border="1" style="margin-left: auto; margin-right: auto;"> <tr><td>L₁</td></tr> <tr><td>10</td></tr> </table>	L ₁	10	A	 <table border="1" style="margin-left: auto; margin-right: auto;"> <tr><td>L₁</td></tr> <tr><td>10</td></tr> <tr><td>15</td></tr> </table>	L ₁	10	15	
L ₁									
10									
L ₁									
10									
15									
6	 <table border="1" style="margin-left: auto; margin-right: auto;"> <tr><td>L₁</td></tr> <tr><td>15</td></tr> <tr><td>20</td></tr> </table>	L ₁	15	20	C	 <table border="1" style="margin-left: auto; margin-right: auto;"> <tr><td>L₁</td></tr> <tr><td>10</td></tr> <tr><td>15</td></tr> </table>	L ₁	10	15
L ₁									
15									
20									
L ₁									
10									
15									
4	 <table border="1" style="margin-left: auto; margin-right: auto;"> <tr><td>L₁</td></tr> <tr><td>15</td></tr> <tr><td>20</td></tr> </table>	L ₁	15	20					
L ₁									
15									
20									

Corresponding Specifications

Dust cover	Available
Tap	Available (Only the center-positioned)

Insulated lever configuration		Unit:mm			
B					
 <table border="1" style="margin-left: auto; margin-right: auto;"> <tr><td>L₁</td></tr> <tr><td>10</td></tr> <tr><td>15</td></tr> </table>	L ₁	10	15		
L ₁					
10					
15					

Note

Marked are specifications recommended by Alps.

Super Slide™ (Standard Type) / Ordering Products Not Listed

When ordering product varieties that are not listed, specify referring to the examples below.

Sample Part Number



Specify the travel distance from the below codes.

Travel (mm)	Code	Travel (mm)	Code
15	15	45	45
20	20	60	60
30	30	—	—

Number of resistor elements

Single	1 (Enter "Y" for 60 mm travel)
Dual	2

Lever type / Length of lever (mm)

Insulated lever

Code	Configuration	Length
J1	J-1	5
0A	A	10
		15
0C	C	10
		15
0B	B	10
		15

Metal lever

Code	Configuration	Length
91	9-1	10
92	9-2	5
04	4	15
		20
06	6	15
		20

Length of operation unit

If the length is less than 10 mm, add a "0" before the number.
(e.x., 5 mm length= "05")

Detent

Code	Detent
C0	Without
C1	Center

Mounting plate

Code	Mounting plate
P0	Without
P1	With

Resistance taper

Code	Resistance taper
A	15A
B	1B
D	10A
W	4B
V	3B

Total resistance

Code	Total resistance (kΩ)	Code	Total resistance (kΩ)
103	10	104	100
203	20	204	200
503	50	—	—

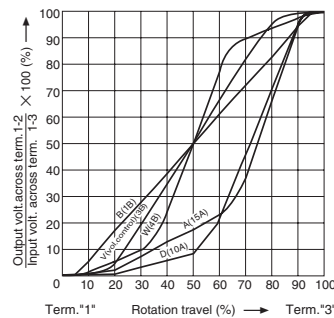





Note

Marked are specifications recommended by Alps.

Slide Potentiometers

List of Varieties

Type		Standard Type			Master Type	
Series		Super Slide™	Slim Slide™ (Slim4)		Compact Reflow Type	K Fader
		RS □□ 1	RS □□ H		RS08U	RS □□ K
		Single-unit/Dual-unit	Single-unit/Dual-unit		Single-unit	Single-unit/Dual-unit
Photo						
Travel (mm)		15, 20, 30, 45, 60	15, 20, 30		8	60, 100
Direction of lever		Vertical		Horizontal	Vertical Horizontal	Vertical
Lever material		Metal / Resin	Resin			Metal
Operating temperature range		-25°C to +70°C			-10°C to +70°C	-10°C to +60°C
Operating life		15,000 cycles	10,000 cycles			100,000 cycles (Standard) 300,000 cycles (CP)
Available for automotive use		○	—	—	—	—
Life cycle (availability)						
Electrical performance	Total resistance (k Ω)	10, 20, 50, 100, 200	5, 10, 20, 50, 100, 200, 250		10	10, 50, 100 (Standard) 10 (CP)
	Resistance taper	10A, 15A, 1B, 3B, 4B	15A, 1B, 3B		1B	15A, 1B
	Rated Power	Please see P.395	Please see P.402		0.025W	0.25W
	Insulation resistance	100MΩ min. 250V DC	Dual-unit: 100MΩ min. 250V DC		100MΩ min. 100V DC	100MΩ min. 250V DC
	Voltage proof	300V AC for 1 minute	Dual-unit: 300V AC for 1 minute		100V AC for 1 minute	250V AC for 1 minute
	Center-taps	Without / With			Without	
Mechanical performance	Operating force	0.3 to 2.5N	0.6 ^{+0.5} _{-0.4} N		0.17±0.15N	Please see P.408
	Center detent	Without / With			Without	
	Stopper strength	50N	30N		5N	100N
	Lever push-pull strength	50N	30N		5N	100N
	Lever wobble (mm) ※ Both sides	$\frac{2(2 \times L)}{20}$	1.6 max.		—	$\frac{2(2 \times L)}{25}$
	Detent slip-out force	Operating force + (0.2 to 2N)	Operating force +0.3 ^{+0.5} _{-0.25} N		—	—
	Lever deviation (mm) ※ One side	0.5 max.	—	—	—	0.5 max.
Terminal style		Insertion			Reflow	Lead (Standard) Connector (CP)
Page		401	410		416	417

Slide Potentiometers Soldering Conditions	438
Potentiometer Cautions	439
Potentiometers Measurement and Test Methods	441
Potentiometers Resistance Taper	443

Notes

- "L" in the "Lever Wobble" column of the above table indicates the length of lever.
- RS □□  indicates travel.
- Indicates applicability to some products in the series.

Reference for Manual Soldering

Series	Tip temperature	Duration of Soldering time	No. of solders
RS□□1, RS□□H, RS08U, RS□□K (Standard), RS□□N, RS□□N11S, RS6011□P, RS□□N1□M, RSA0K1□V (Motor terminal)	350°C max.	3s max.	1 time

Reference for Dip Soldering

Series	Preheating		Dip soldering		Number of soldering
	Soldering surface temperature	Heating time	Soldering temperature	Soldering time	
RS□□1, RS□□H, RS□□N, RS□□N11S, RS6011□P, RS□□N1□M	100°C max.	1 min. max.	260°C	5s max.	1 time

Example of Reflow Soldering Condition

Temperature profile

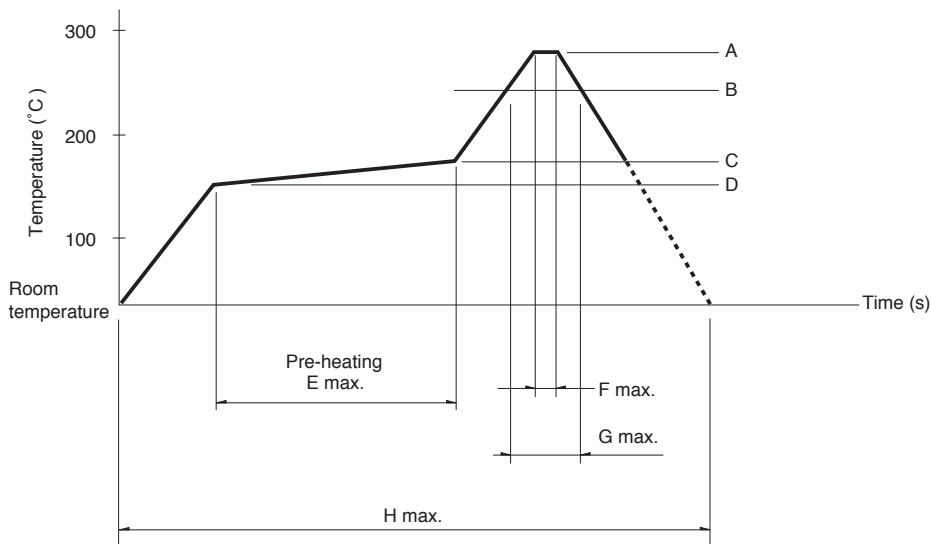

Series	A	B	C	D	E	F	G	H	No. of reflows
RS08U	250°C	200°C	150°C	150°C	2 min.	3s	40s	4 min.	1 time

Notes

1. When using an infrared reflow oven, solder may sometimes not be applied. Be sure to use a hot air reflow oven or a type that uses infrared rays in combination with hot air.
2. The temperatures given above are the maximum temperatures at the terminals of the potentiometer when employing a hot air reflow method. The temperature of the PC board and the surface temperature of the potentiometer may vary greatly depending on the PC board material, its size and thickness. Ensure that the surface temperature of the potentiometer does not rise to 250°C or greater.
3. Conditions vary to some extent depending on the type of reflow bath used. Be sure to give due consideration to this prior to use.