	DATA SHEET	Part No.
	COMMON MODE ESD FILTER	ACFE4A2G900E

CUSTOMER :

DATA SHEET

Product Name : COMMON MODE ESD FILTER

Part No : ACFE4A2G900E

Revision Date : 2016/12/08

Customer Code :

	Address : AMOTECH. CO. LTD., 17-2 ,JAMWON-DONG, SEOCHO-GU, SEOUL,KOREA
	Contact : TEL) 82-2-544-1351, FAX) 82-2-517-7183

1. Parts description

1.1. Overview

ACF series is multi-layer chip Common Mode Filter for high speed differential transmission line. This product shows excellent noise reduction without signal loss by high coupled Inductor pair.

1.2. Features

- Excellent noise reduction without signal loss
- Built-in two ESD suppression devices each line
- Low profile (T = 0.47 mm)
- Ceramic multilayer type SMD component
- RoHS compliance

1.3. Applications

- High speed differential transmission lines at electronic devices (ex. MIPI, USB2.0, etc.)
- LCD/PDP TV, DSC, DVC, DVD player, notebook, PC, portable audio player, mobile phones, etc.

2. Model and Lot Number description

2.1. Model

ACF	E	4A	2	G	900	E
(1)	(2)	(3)	(4)	(5)	(6)	(7)

- (1) Series name
- (2) Function : "E" - ESD suppression devices
- (3) Chip size : "4A" - 0.87 X 0.67
- (4) Number of Lines : "2" - 2 lines
- (5) Characteristics : "G" - for Gbps
- (6) Impedance : "900" - 90Ω
- (7) Internal code

3. Style and Dimension

3.1. Appearance and dimension

• Top view

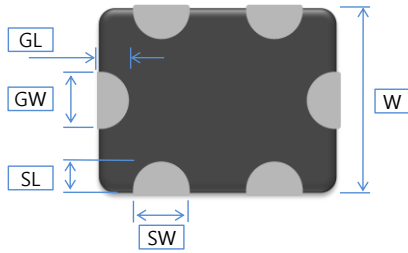

• Side view

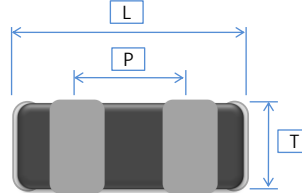

Item	Size (mm)
L	0.87 ± 0.05
W	0.67 ± 0.05
T	0.47 ± 0.05
SL	0.15 ± 0.05
SW	0.20 ± 0.05
GL	0.15 ± 0.05
GW	0.20 ± 0.05
P	0.40 ± 0.05

3.2. Equivalent circuit & Pin description

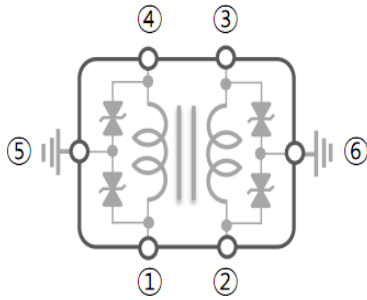

No.	Pin Description
①/④	In/ Out line (Data)
②/③	In/ Out line (Data)
⑤, ⑥	Ground (Common)

※ No Polarity & Directionality

4. Structure and materials

	Item	Material
	Body1	Ni-Zn Ferrite
	Body2	Glass + Alumina
	Internal electrode	Ag
	External electrode	Ag – Ni– Sn
	Plate layer	Ni ≥ 1 μm, Sn ≥ 2 μm

5. Specifications

5.1. Electrical characteristics

Parameter	Common Mode Impedance @ 100 MHz	DC Resistance	Capacitance @ 1MHz	Rated Voltage	Rated Current	Insulation Resistance	Leakage Current @ 5Vdc
Symbol	Z_{CM}	R_{DC}	C_P	V_{DC}	I_{DC}	IR	I_L
Units	Ω	Ω	pF	V (DC)	mA (DC)	$M\Omega$	μA
Value	$90 \pm 30\%$	1.0 ~ 5.0	Max. 1.7	5	100	Min. 10	Max. 1.0

5.2. Frequency characteristics

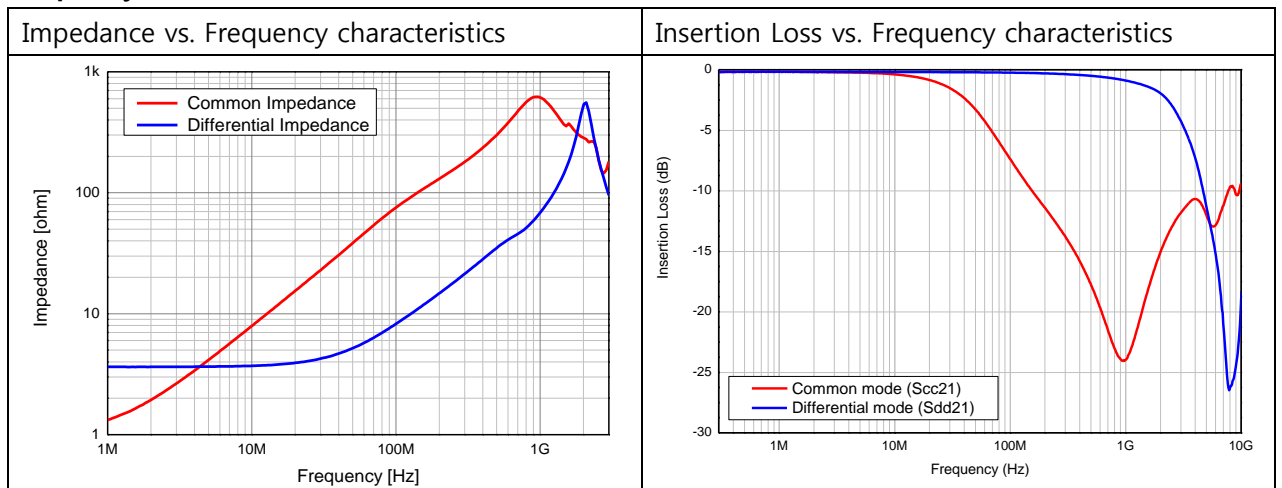

5.3. Temperature range

- 1) Operating Temperature range : -40 ~ +85°C
- 2) Storage Temperature range : -40 ~ +85°C

5.4. Measurement method

When measuring and supplying the voltage, the following terminal is applied.

parameter	Common Mode Impedance	DC Resistance	Capacitance	Insulation Resistance	Leakage Current
Equipment	Agilent E4991A Impedance Analyzer	Agilent 4338B Milliohm Meter	Agilent 4288A capacitance meter	KEITHLEY 2400	KEITHLEY 2400
Terminal to be Tested					

6. Soldering (Reflow soldering)

6.1. Soldering condition

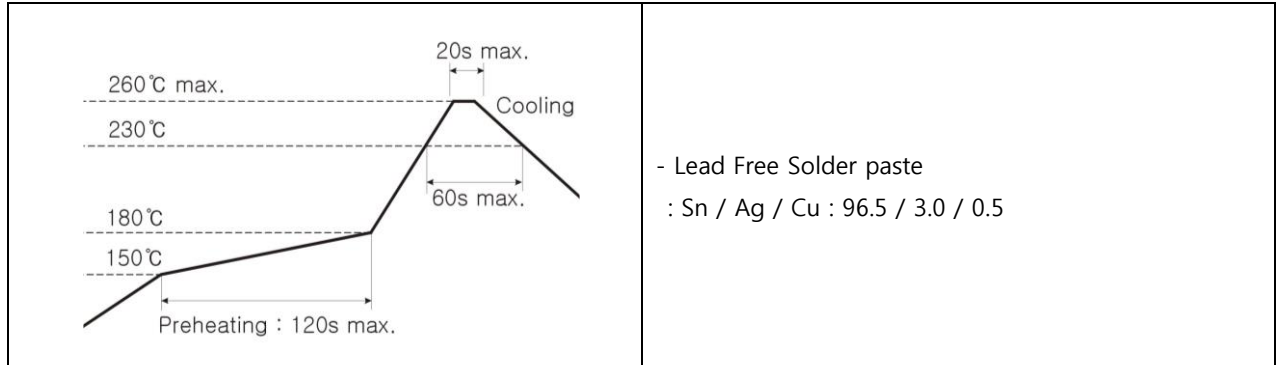

Follow the recommended soldering conditions to avoid degradation of performance .

- This product is designed for reflow soldering only. Do not use flow soldering.
- Use non-activated flux. (Max. Cl content less than 0.2%)
- Reflow cycle times should be done less than 3 times.

6.2. PCB pattern design condition (recommended)

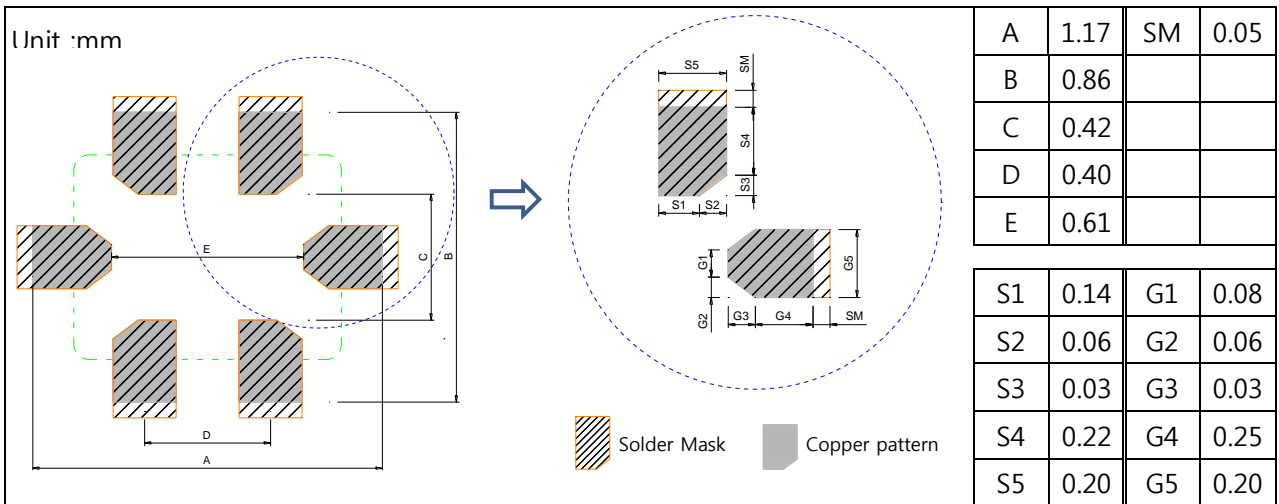

7. Caution

- 1) Storage environment : -5~40°C temperature, 20~70% humidity (MSL Level 1)
- 2) Do not use in high temperature/high humidity and a corrosive atmosphere like sulfide, chloride gas which could damage the solderability.
- 3) Do not expose to mechanical shock to avoid crack.
- 4) Use chips within 6 months. If over 6 months, check solderability before use.

8. Packaging specification

8.1 Carrier tape Specification

8.1.1. Size

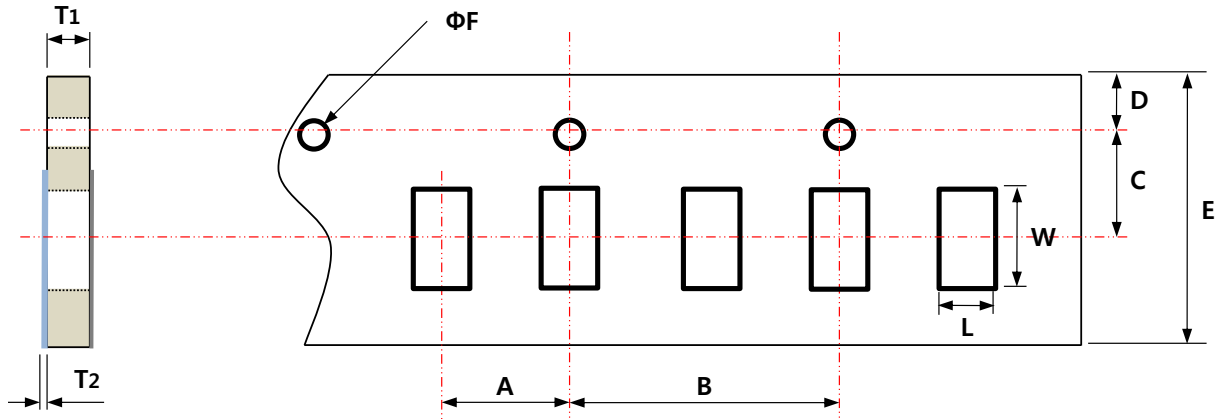

	L	W	A	B	C	D	E	ΦF	T1	T2
Tolerance	±0.10	±0.10	±0.10	±0.10	±0.10	±0.10	±0.10	+0.10	±0.10	Max.
Spec (mm)	0.77	0.97	2.00	4.00	3.50	1.75	8.00	1.55	0.60	0.10

8.1.2. Chip Locations

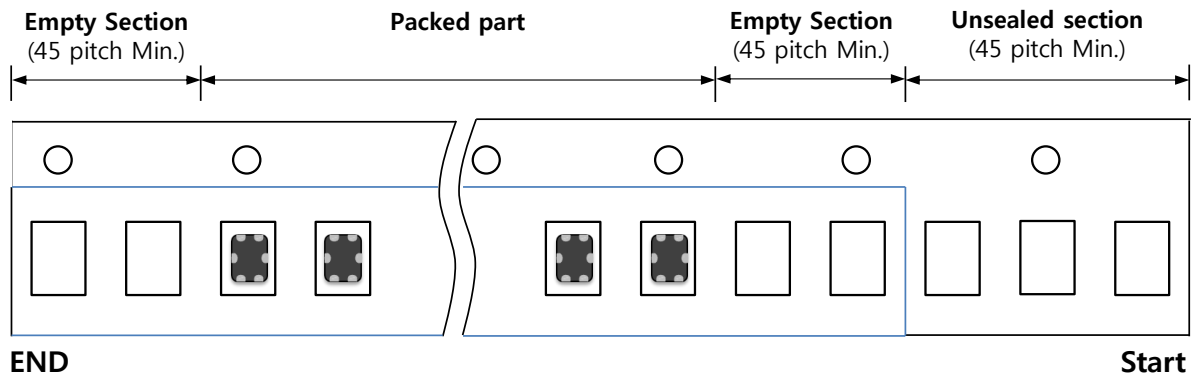

8.1.3. Material

- 1) Pater carrier tape : Laminated virgin pulp
- 2) Top tape : Polyester film
- 3) Bottom tape : Adhesive coated paper

8.2. Reel Specification

8.2.1. Size

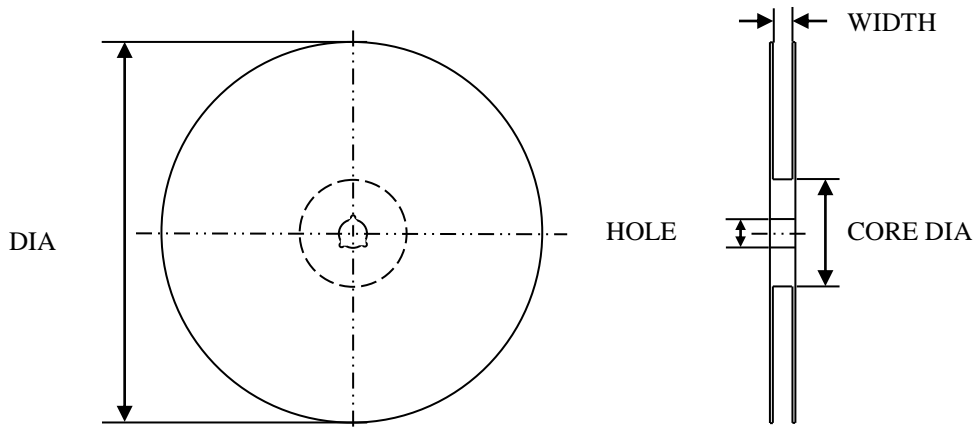

Item	DIA	WIDTH	CORE DIA	HOLE
Size (mm)	178.0±0.5	9.0±0.5	60.0±1.0	13.2±0.3

8.2.2. Label adherence and winding direction

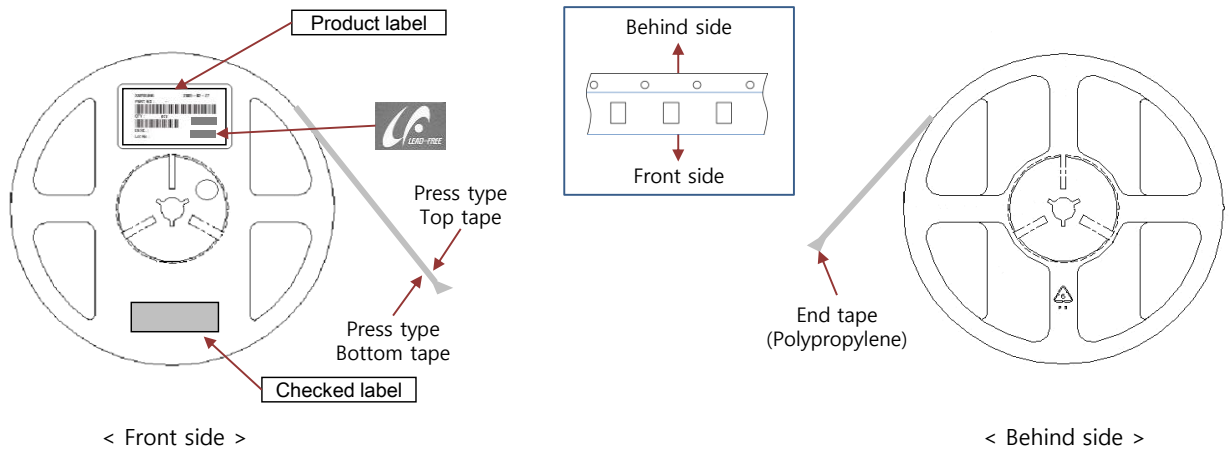



8.2.3. Material

- 1) Carrier Tape : PET / PC / PS
- 2) Plastic reel : GPS(General Purpose Styrene)

	DATA SHEET	Part No.
	COMMON MODE ESD FILTER	ACFE4A2G900E

8.3 Box packaging Specification

Box	Small	Medium	Large
Size (mm)	183 (W) x 185 (D) x 70 (T)	200 (W) x 375 (D) x 205 (T)	375 (W) x 390 (D) x 205 (T)
Quantity	5 reel = 10,000 ea/reel x 5 = 50,000 ea	5 small boxes = 10,000 ea/reel X 25 = 250,000 ea	10 Medium boxes = 10,000 ea/reel X 50 = 500,000 ea
Detail			

8.4. Label Specification

Size : Reel & Small boxes : 80 X 40 (mm)

Medium & Large boxes : 100 X 100 (mm)