

— 주 기 —

1. 사용상 유해한 흠, BURR등이 없을 것.
2. 명시되지 않은 R=0.3 으로 할 것.
3. MARKING 및 CAV. No.는 당사 규정에 준할 것.
4. MATCHING CONNECTOR : HN126-01020
5. 적용 Corrugated Tube : $\phi 5$

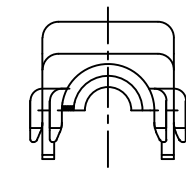

SECTION X-X

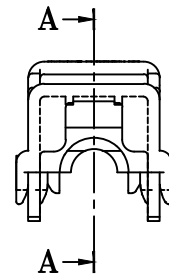
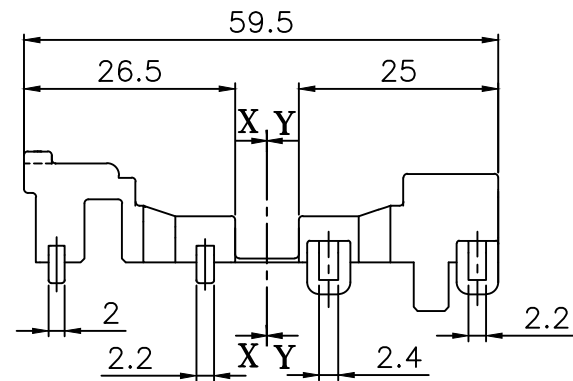
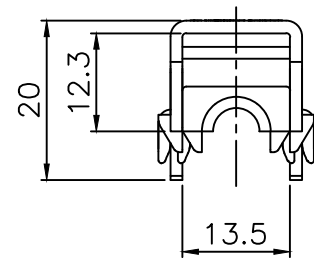
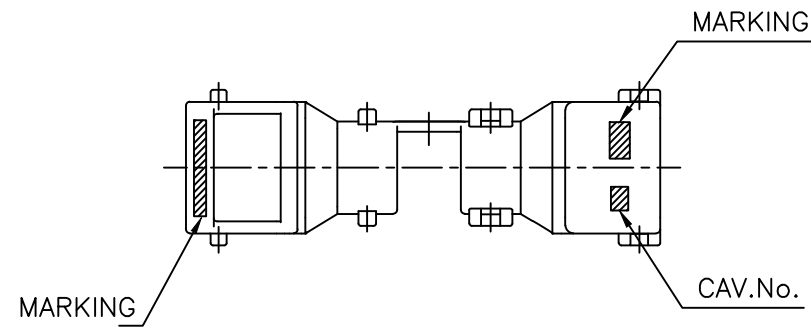
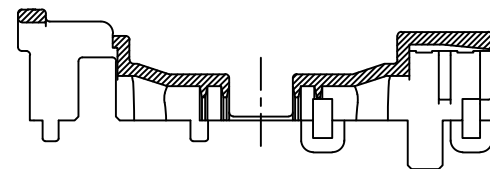

SECTION A-A

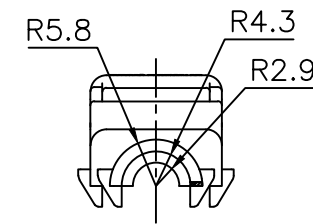

SECTION Y-Y

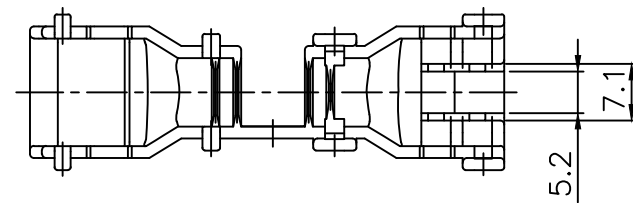

CJW	06.07.18	-	△	신 규	SSJ
승인	DATE	NOTE NO.	SYM	ALTERATION	담당

DRAWING NAME COVER NMWP01FA-B

DRAWING NO. HV015-01020-C01

GENERAL TOLERANCE							
	10MAX	50MAX	100MAX	150MAX	200MAX	200VR	ANGLE
A	±0.2	±0.3	±0.5	±0.8	±1.0	±1.4	± 30'

COVER NMWP01FA-B		HV015-01020		BLACK	PA66
PART NAME		PART NO.		COLOR	MATERIAL
THIRD ANGLE PROJECTION	A	1/1	KNJ	SSJ	CJW
	TOLERANCE	SCALE	DESIGN	DRAWN	CHECKED APPROVED

KUM 케이유엠