



US1AF THRU US1MF

SURFACE MOUNT ULTRA FAST RECTIFIER

Reverse Voltage - 50 to 1000 Volts Forward Current - 1.0 Ampere

SMAF

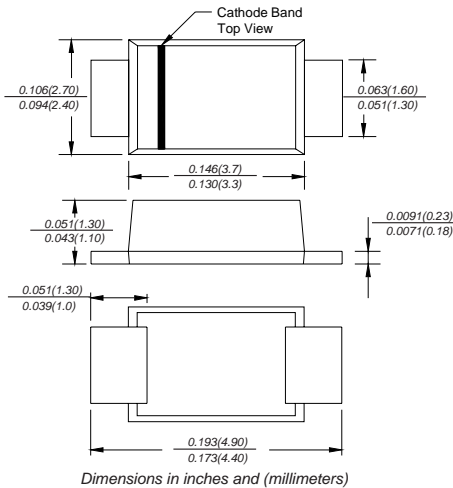

FEATURES

- ◆ The plastic package carries Underwriters Laboratory Flammability Classification 94V-0
- ◆ For surface mounted applications
- ◆ Ultra fast switching for high efficiency
- ◆ Low reverse leakage
- ◆ Built-in strain relief, ideal for automated placement
- ◆ High forward surge current capability
- ◆ High temperature soldering guaranteed 260 C/10 seconds at terminals
- ◆ Glass passivated chip junction

MECHANICAL DATA

Case: JEDEC SMAF molded plastic body over passivated chip
Terminals: Solder plated, solderable per MIL-STD-750, Method 2026

Polarity: Color band denotes cathode end

Mounting Position: Any

Weight: 0.0018 ounce, 0.064 grams

MAXIMUM RATINGS AND ELECTRICAL CHARACTERISTICS

Ratings at 25°C ambient temperature unless otherwise specified.

Single phase half-wave 60Hz, resistive or inductive load, for capacitive load current derate by 20%.

| MDD Catalog Number | SYMBOLS | US1AF | US1BF | US1DF | US1GF | US1JF | US1KF | US1MF | UNITS |
|---|-----------------|-------------|-----------|-----------|-----------|-----------|-----------|-----------|--------------------|
| | | MDD US1AF | MDD US1BF | MDD US1DF | MDD US1GF | MDD US1JF | MDD US1KF | MDD US1MF | |
| Marking code | | | | | | | | | |
| Maximum repetitive peak reverse voltage | V_{RRM} | 50 | 100 | 200 | 400 | 600 | 800 | 1000 | VOLTS |
| Maximum RMS voltage | V_{RMS} | 35 | 70 | 140 | 280 | 420 | 560 | 700 | VOLTS |
| Maximum DC blocking voltage | V_{DC} | 50 | 100 | 200 | 400 | 600 | 800 | 1000 | VOLTS |
| Maximum average forward rectified current at $T_L=55^\circ\text{C}$ | $I_{(AV)}$ | 1.0 | | | | | | | Amp |
| Peak forward surge current 8.3ms single half sine-wave superimposed on rated load (JEDEC Method) | I_{FSM} | 30.0 | | | | | | | Amps |
| Maximum instantaneous forward voltage at 1.0A | V_F | 1.0 | | 1.4 | | 1.7 | | | Volts |
| Maximum DC reverse current $T_A=25^\circ\text{C}$ at rated DC blocking voltage $T_A=100^\circ\text{C}$ | I_R | 5.0 50.0 | | | | | | | μA |
| Maximum reverse recovery time (NOTE 1) | t_{rr} | 50 | | | | 75 | | | ns |
| Typical junction capacitance (NOTE 2) | C_J | 15.0 | | | | | | | pF |
| Typical thermal resistance (NOTE 3) | $R_{\theta JA}$ | 50.0 | | | | | | | $^\circ\text{C/W}$ |
| Operating junction and storage temperature range | T_J, T_{STG} | -50 to +150 | | | | | | | $^\circ\text{C}$ |

- Note:** 1. Reverse recovery condition $I_F=0.5\text{A}, I_R=1.0\text{A}, I_{rr}=0.25\text{A}$
 2. Measured at 1MHz and applied reverse voltage of 4.0V D.C.
 3. P.C.B. mounted with 0.2x0.2" (5.0x5.0mm) copper pad areas



www.microdiode.com

RATINGS AND CHARACTERISTIC CURVES US1AF THRU US1MF

AVERAGE FORWARD RECTIFIED CURRENT,
AMPERES

FIG. 1- FORWARD CURRENT DERATING CURVE

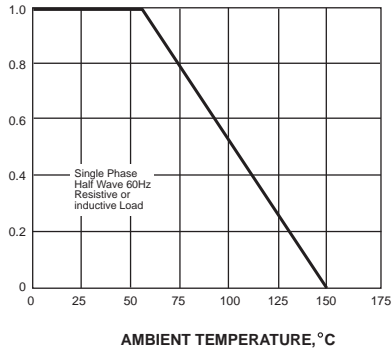

PEAK FORWARD SURGE CURRENT,
AMPERES

FIG. 2-MAXIMUM NON-REPETITIVE PEAK FORWARD SURGE CURRENT

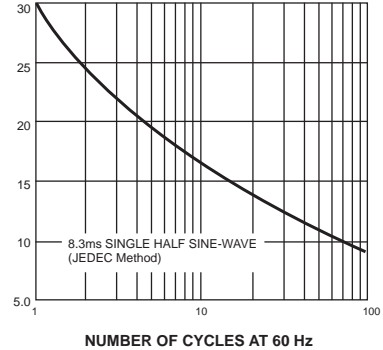

INSTANTANEOUS FORWARD CURRENT, AMPERES

FIG. 3-TYPICAL INSTANTANEOUS FORWARD CHARACTERISTICS

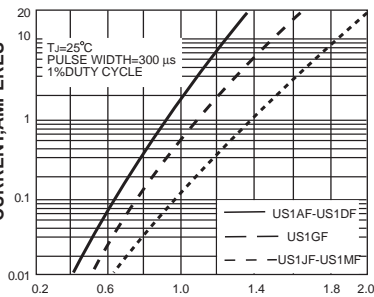

INSTANTANEOUS FORWARD VOLTAGE,
VOLTS

INSTANTANEOUS REVERSE CURRENT,
MICROAMPERES

FIG. 4-TYPICAL REVERSE CHARACTERISTICS

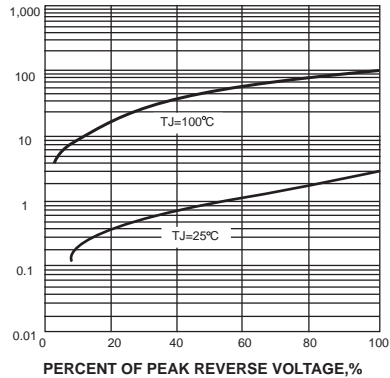

PERCENT OF PEAK REVERSE VOLTAGE, %

JUNCTION CAPACITANCE, pF

FIG. 5-TYPICAL JUNCTION CAPACITANCE

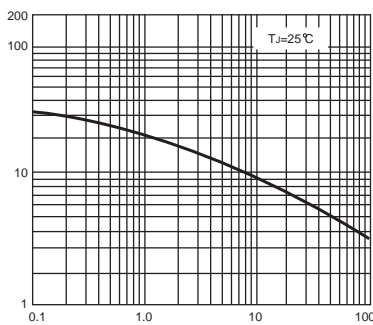

REVERSE VOLTAGE, VOLTS

TRANSIENT THERMAL IMPEDANCE,
°C/W

FIG. 6-TYPICAL TRANSIENT THERMAL IMPEDANCE

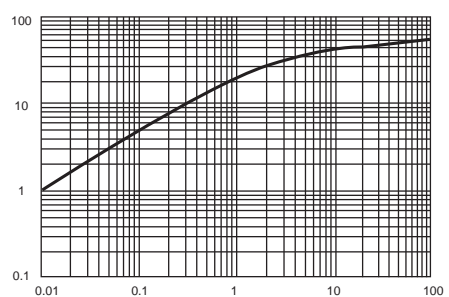

t, PULSE DURATION, sec.

The cruve graph is for reference only, can't be the basis for judgment(曲线图仅供参考!)



www.microdiode.com