



Micro Commercial Components

Micro Commercial Components
20736 Marilla Street Chatsworth
CA 91311
Phone: (818) 701-4933
Fax: (818) 701-4939

2N7002K

Features

- Epoxy meets UL 94 V-0 flammability rating
- Moisture Sensitivity Level 1
- High density cell design for low $R_{DS(ON)}$
- Voltage controlled small signal switch
- Rugged and reliable
- ESD Protected up to 2KV (HBM)
- Marking : 72K
- Halogen free available upon request by adding suffix "-HF"

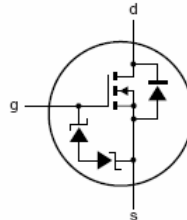

N-Channel MOSFET

Maximum Ratings @ 25°C Unless Otherwise Specified

Symbol	Rating	Rating	Unit
V_{DS}	Drain-source Voltage	60	V
V_{GS}	Gate-source Voltage	± 20	V
I_D	Drain Current	340	mA
P_D	Total Power Dissipation	350	mW
T_J	Operating Junction Temperature	-55 to +150	°C
T_{STG}	Storage Temperature	-55 to +150	°C
R_{thJA}	Thermal Resistance from Junction to Ambient	357	°C/W

SOT-23

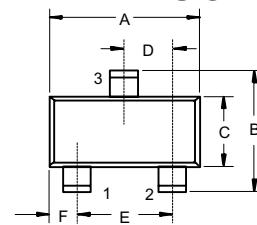

1. GATE
2. SOURCE
3. DRAIN

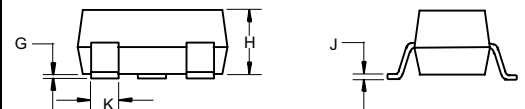

Electrical Characteristics @ 25°C Unless Otherwise Specified

Symbol	Parameter	Min	Typ	Max	Units
$V_{(BR)DSS}$	Drain-Source Breakdown Voltage ($V_{GS}=0Vdc, I_D=10\mu A$)	60	---	---	Vdc
$V_{GS(th)}$	Gate-Threshold Voltage ($V_{DS}=V_{GS}, I_D=1mA$)	1.0	1.3	2.5	Vdc
I_{GSS}	Gate-body Leakage ($V_{DS}=0Vdc, V_{GS}=\pm 10Vdc$) ($V_{DS}=0Vdc, V_{GS}=\pm 5Vdc$)	---	---	± 200 ± 100	nA nA
I_{DSS}	Zero Gate Voltage Drain Current ($V_{DS}=48Vdc, V_{GS}=0Vdc$)	---	---	1	μA
$r_{DS(on)}$	Drain-Source On-Resistance ($V_{GS}=4.5Vdc, I_D=200mA$) ($V_{GS}=10Vdc, I_D=500mA$)	---	---	5.3 5.0	Ω
V_{SD}	Diode Forward Voltage ($V_{GS}=0Vdc, I_S=300mA$)	---	---	1.5	Vdc
Q_r	Recovered charge ($V_{GS}=0V, I_S=300mA, V_R=25V$) ($di_s/dt=-100A/\mu S$)	---	30	---	nC
C_{iss}	Input Capacitance	---	---	40	pF
C_{oss}	Output Capacitance	---	---	30	
C_{rss}	Reverse Transfer Capacitance	---	---	10	

DIM	INCHES		MM		NOTE
	MIN	MAX	MIN	MAX	
A	.110	.120	2.80	3.04	
B	.083	.104	2.10	2.64	
C	.047	.055	1.20	1.40	
D	.035	.041	.89	1.03	
E	.070	.081	1.78	2.05	
F	.018	.024	.45	.60	
G	.0005	.0039	.013	.100	
H	.035	.044	.89	1.12	
J	.003	.007	.085	.180	
K	.015	.020	.37	.51	

Suggested Solder Pad Layout

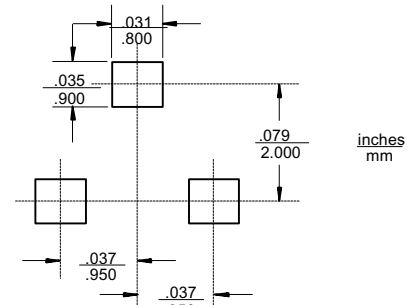

Switching

$t_{d(on)}$	Turn-on Time	$V_{DD}=50V, R_L=250\Omega,$ $R_{GS}=50\Omega, V_{GS}=10V,$ $R_G=50\Omega$	---	---	10	ns
$t_{d(off)}$	Turn-off Time		---	---	15	
t_{rr}	Reverse recovery time	$V_{GS}=0V, I_S=300mA,$ $V_R=25V,$ $di_s/dt=-100A/\mu S$	---	30	---	

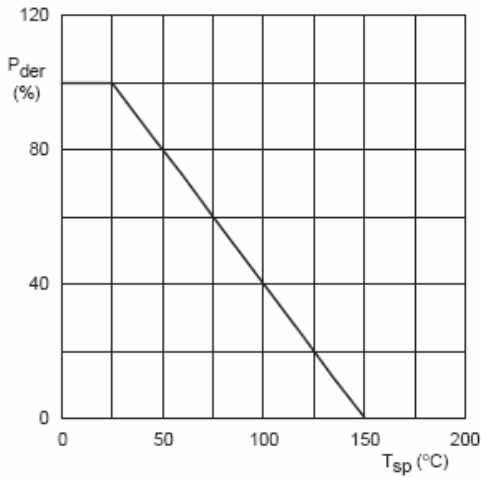

$$P_{der} = \frac{P_{tot}}{P_{tot(25^{\circ}C)}} \times 100\%$$

Fig 1. Normalized total power dissipation as a function of solder point temperature.

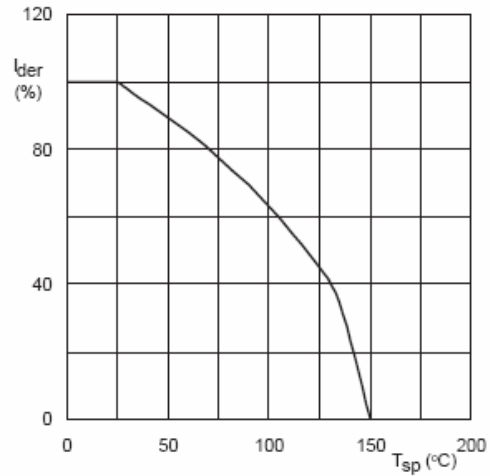

$$I_{der} = \frac{I_D}{I_{D(25^{\circ}C)}} \times 100\%$$

Fig 2. Normalized continuous drain current as a function of solder point temperature.

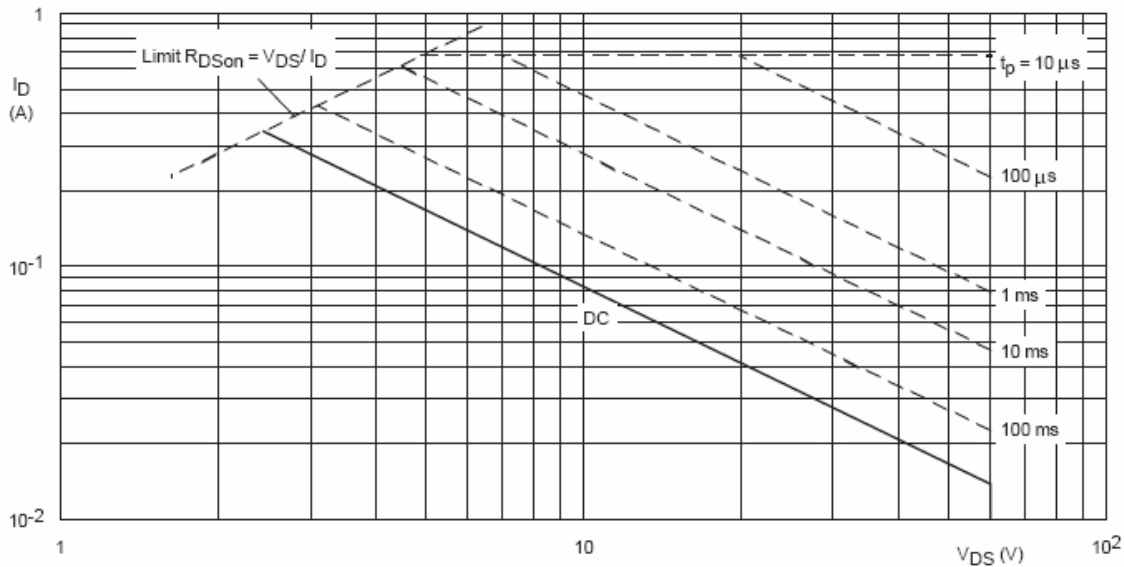

T_{sp} = 25 °C; I_{DM} is single pulse; V_{GS} = 10 V

Fig 3. Safe operating area; continuous and peak drain currents as a function of drain-source voltage.

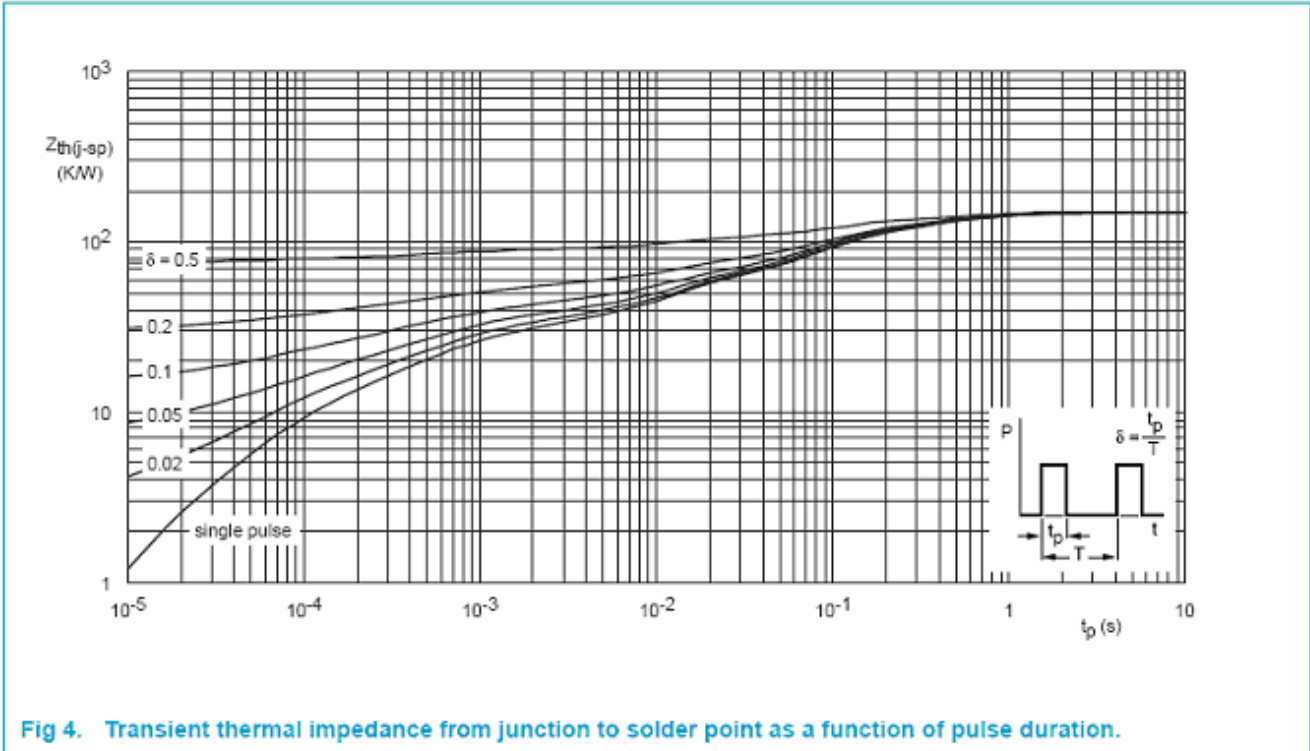

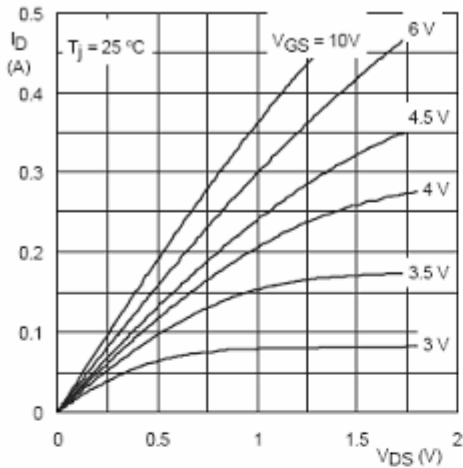

$T_j = 25^\circ\text{C}$

Fig 5. Output characteristics: drain current as a function of drain-source voltage; typical values.

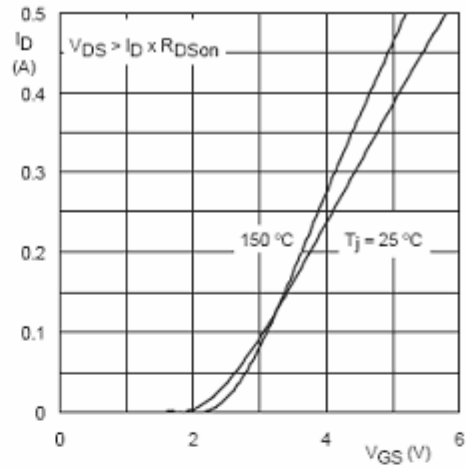

$T_j = 25^\circ\text{C}$ and 150°C ; $V_{DS} > I_D \times R_{DSon}$

Fig 6. Transfer characteristics: drain current as a function of gate-source voltage; typical values.

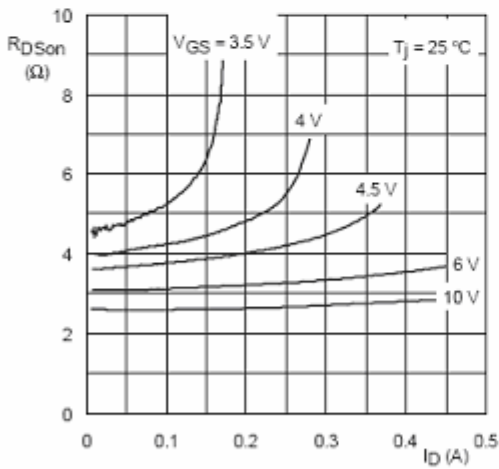

$T_j = 25^\circ\text{C}$

Fig 7. Drain-source on-state resistance as a function of drain current; typical values.

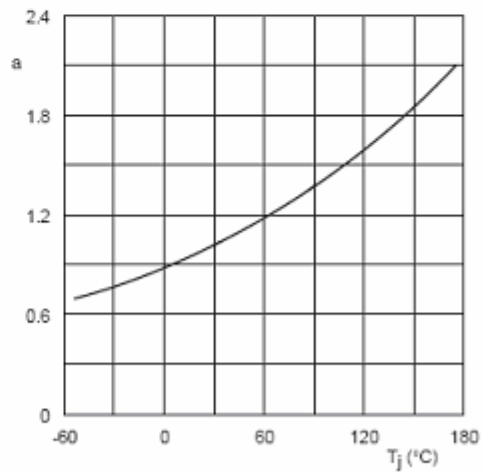

$$a = \frac{R_{DSon}}{R_{DSon(25^\circ\text{C})}}$$

Fig 8. Normalized drain-source on-state resistance factor as a function of junction temperature.

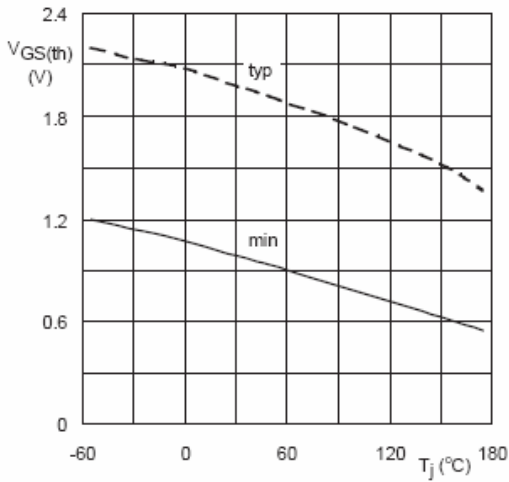

$I_D = 1 \text{ mA}; V_{DS} = V_{GS}$

Fig 9. Gate-source threshold voltage as a function of junction temperature.

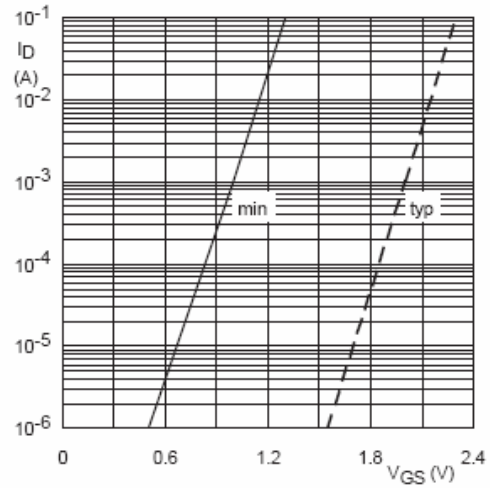

$T_j = 25 \text{ °C}; V_{DS} = 5 \text{ V}$

Fig 10. Sub-threshold drain current as a function of gate-source voltage.

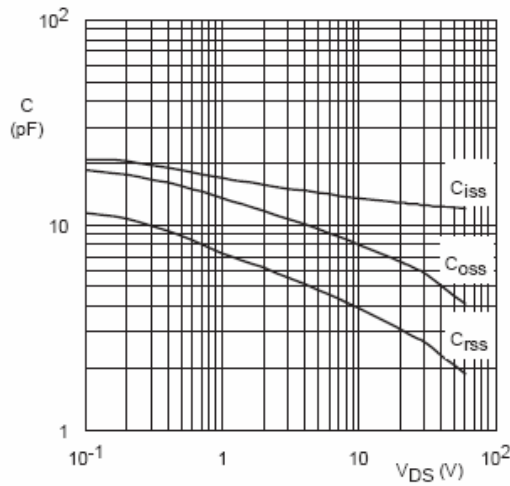

$V_{GS} = 0 \text{ V}; f = 1 \text{ MHz}$

Fig 11. Input, output and reverse transfer capacitances as a function of drain-source voltage; typical values.

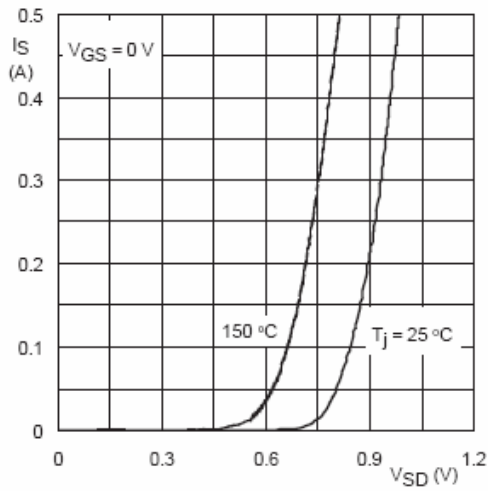

$T_j = 25^\circ\text{C}$ and 150°C ; $V_{GS} = 0$ V

Fig 12. Source (diode forward) current as a function of source-drain (diode forward) voltage; typical values.

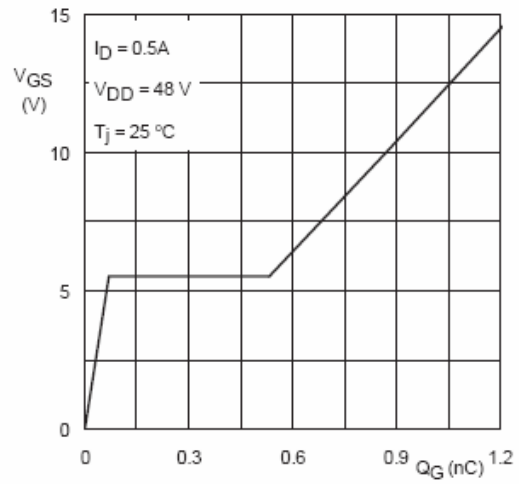

$I_D = 0.5$ A; $V_{DD} = 48$ V

Fig 13. Gate-source voltage as a function of gate charge; typical values.



Micro Commercial Components

Ordering Information :

Device	Packing
Part Number-TP	Tape&Reel: 3Kpcs/Reel

Note : Adding "-HF" suffix for halogen free, eg. Part Number-TP-HF

IMPORTANT NOTICE

Micro Commercial Components Corp. reserves the right to make changes without further notice to any product herein to make corrections, modifications , enhancements , improvements , or other changes . **Micro Commercial Components Corp .** does not assume any liability arising out of the application or use of any product described herein; neither does it convey any license under its patent rights ,nor the rights of others . The user of products in such applications shall assume all risks of such use and will agree to hold **Micro Commercial Components Corp .** and all the companies whose products are represented on our website, harmless against all damages.

LIFE SUPPORT

MCC's products are not authorized for use as critical components in life support devices or systems without the express written approval of Micro Commercial Components Corporation.

CUSTOMER AWARENESS

Counterfeiting of semiconductor parts is a growing problem in the industry. Micro Commercial Components (MCC) is taking strong measures to protect ourselves and our customers from the proliferation of counterfeit parts. MCC strongly encourages customers to purchase MCC parts either directly from MCC or from Authorized MCC Distributors who are listed by country on our web page cited below. Products customers buy either from MCC directly or from Authorized MCC Distributors are genuine parts, have full traceability, meet MCC's quality standards for handling and storage. **MCC will not provide any warranty coverage or other assistance for parts bought from Unauthorized Sources.** MCC is committed to combat this global problem and encourage our customers to do their part in stopping this practice by buying direct or from authorized distributors.

www.mccsemi.com