

## MBR10100CT&MBR10100FCT

### 10.0AMPS. SCHOTTKY BARRIER RECTIFIERS

#### FEATURE

- . High current capability
- . Low forward voltage drop
- . Low power loss, high efficiency
- . High surge capability
- . High temperature soldering guaranteed  
260°C /10seconds, 0.25"(6.35mm)from case.

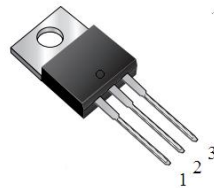

TO-220AB  
MBR10100CT

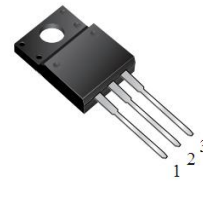

ITO-220AB  
MBR10100FCT

#### MECHANICAL DATA

- . Case: Molded with UL-94 Class V-0 recognized  
Flame Retardant Epoxy
- . Mounting position: any

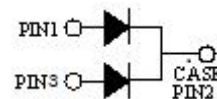

Single phase, half wave, 60Hz, resistive or inductive load.

For capacitive load, derate current by 20%

#### MAXIMUM RATINGS (T<sub>C</sub>=25°C unless otherwise noted)

Parameter	Symbol	MBR10100CT&MBR10100FCT	Units
Maximum Recurrent Peak Reverse Voltage	V <sub>RRM</sub>	100	V
Maximum RMS Voltage	V <sub>RMS</sub>	70	V
Maximum DC blocking Voltage	V <sub>DC</sub>	100	V
Maximum Average Forward Rectified Current <i>Per Leg</i> at T <sub>C</sub> =100°C <i>Total device</i>	I <sub>F(AV)</sub>	5.0 10.0	A
Peak Forward Surge Current 8.3ms single half sine-wave superimposed on rated load (JEDEC method) <i>Per Leg</i>	I <sub>FSM</sub>	120.0	A
Typical Junction Capacitance (Note 1)	C <sub>J</sub>	220	pF
Operation Junction Temperature and Storage Temperature	T <sub>J</sub> , T <sub>STG</sub>	-55 to +150	°C
Maximum Mounting torque, M3 or 6-32 screw		1.1N•m (10 lbf•in)	

#### ELECTRICAL CHARACTERISTICS (T<sub>C</sub>=25°C unless otherwise noted)

Parameter	Symbol	Test conditions	Typ	Max	Units	
Forward voltage drop	V <sub>F</sub>	T <sub>J</sub> =25°C	I <sub>F</sub> =3A	0.68	---	V
			I <sub>F</sub> =5A	0.73	0.80	
		T <sub>J</sub> =125°C	I <sub>F</sub> =3A	0.55	---	
			I <sub>F</sub> =5A	0.60	0.70	
Reverse leakage current	I <sub>R</sub>	T <sub>J</sub> =25°C	V <sub>R</sub> =100V	---	0.1	mA
		T <sub>J</sub> =125°C	V <sub>R</sub> =100V	---	6	

#### THERMAL CHARACTERISTICS (T<sub>C</sub>=25°C unless otherwise noted)

Parameter	Symbol	MBR10100CT	MBR10100FCT	Units
Typical Thermal Resistance (Note 2)	R <sub>(JC)</sub>	2.5	3.5	°C/W

#### Notes:

1. Measured at 1.0 MHz and applied reverse voltage of 4.0Vdc
2. Thermal Resistance from Junction to Case

RATING AND CHARACTERISTIC CURVES

FIG.1-TYPICAL FORWARD CURRENT DERATING CURVE

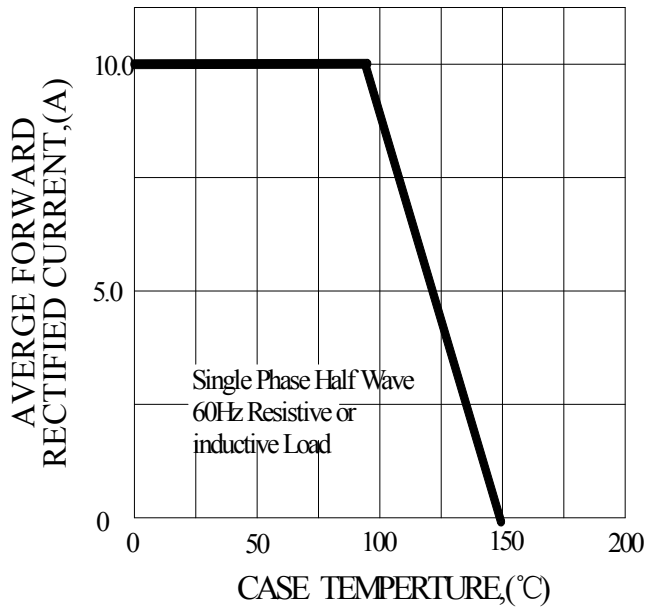

FIG.2-TYPICAL INSTANTANEOUS FORWARD CHARACTERISTICS

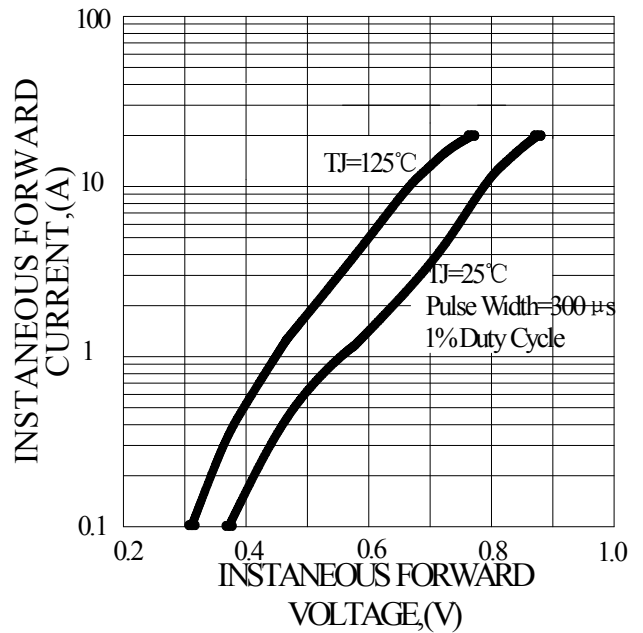

FIG.3-MAXIMUM NON-REPETITIVE FORWARD SURGE CURRENT

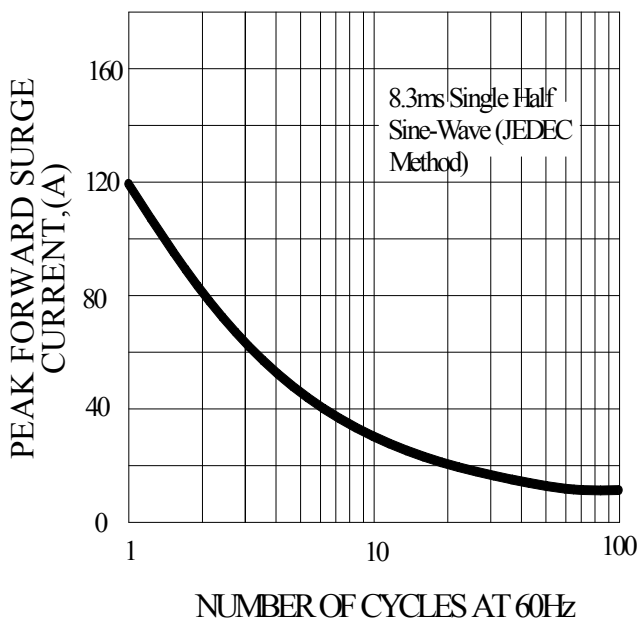
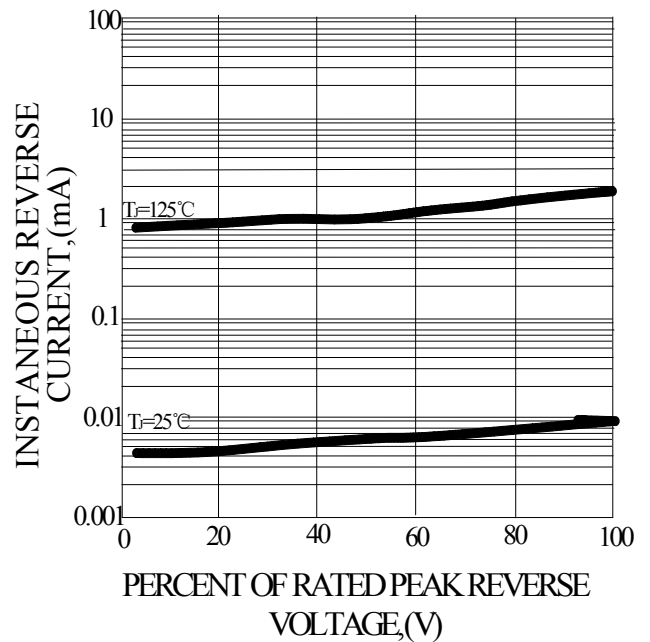
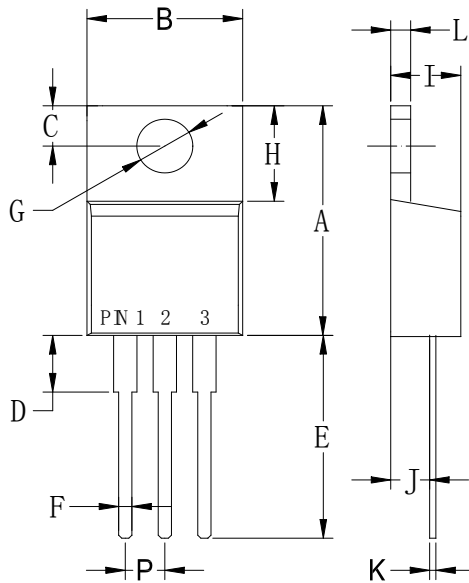

FIG.4-TYPICAL REVERSE CHARACTERISTICS



**PACKAGE OUTLINE DIMENSIONS**

**TO-220AB**



TO-220AB		
Dim	Min	Max
A	.573 (14.55)	.603 (15.32)
B	—	.412 (10.5)
C	.103 (2.62)	.113 (2.87)
D	.140 (3.56)	.160 (4.06)
E	.510 (13.0)	.560 (14.3)
F	.027 (0.68)	.037 (0.94)
G	.148 (3.74)	.154 (3.91)
H	.230 (5.84)	.270 (6.86)
I	.175 (4.44)	.185 (4.86)
J	.100 (2.54)	.110 (2.79)
K	.014 (0.35)	.025 (0.64)
L	.045 (1.14)	.055 (1.40)
P	.095 (2.41)	.105 (2.67)

Dimensions in inches and (millimeters)

**ITO-220AB**

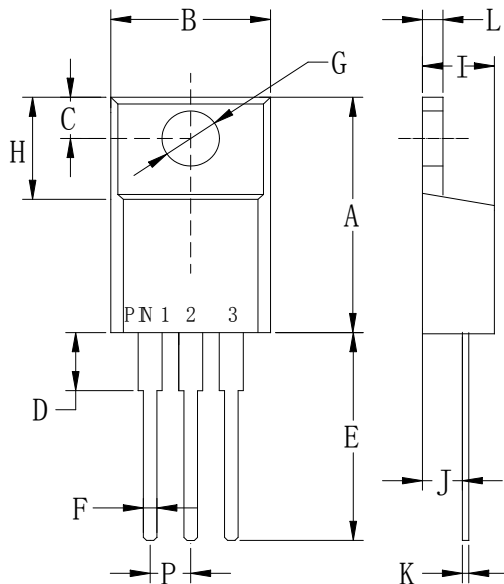

ITO-220AB		
Dim	Min	Max
A	.571 (14.5)	.610 (15.5)
B	.383 (9.72)	.406 (10.3)
C	.110 (2.80)	.126 (3.20)
D	.133 (3.38)	.162 (4.10)
E	.512 (13.0)	.551 (14.0)
F	.028 (0.70)	.035 (0.90)
G	.114 (2.90)	.138 (3.50)
H	.268 (6.80)	.291 (7.40)
I	.162 (4.10)	.185 (4.70)
J	.102 (2.60)	.110 (2.80)
K	.018 (0.45)	.026 (0.65)
L	.097 (2.46)	.113 (2.86)
P	.890 (2.25)	.113 (2.85)

Dimensions in inches and (millimeters)

## Marking and packaging illustration

### 1、Marking

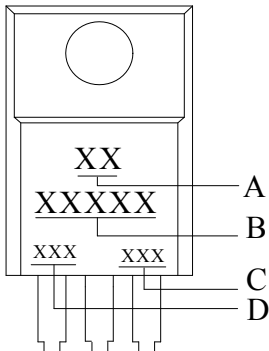

SYMBOL	Explanation
<b>A</b>	Trademark
<b>B</b>	Product Name
<b>C</b>	Date Code
<b>D</b>	Product Information

### 2、Packaging

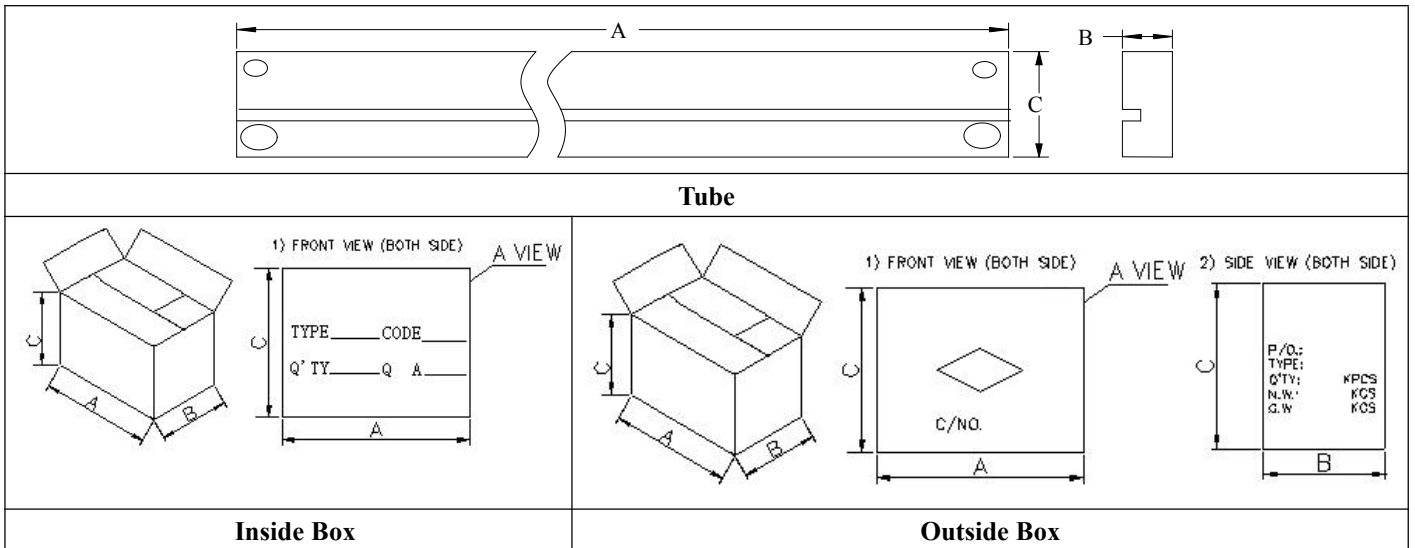

类别	A (mm)	B (mm)	C (mm)
T0-220 Tube (50EA per tube )	530±5	7±0.8	33±1
T0-220 Inside Box (1K per box)	542±5	82±2	78±1
T0-220 outside Box (6K per box)	555±5	285±5	245±5