

MESSRS

S P E C I F I C A T I O N

METALLIZED POLYESTER FILM CAPACITORS

TYPE M M C

NISSEI ELECTRIC CO., LTD.

SPECIFICATION	METALLIZED POLYESTER FILM CAPACITORS	SPEC No. P S C 3 0 5 0 0 0																																										
<p>1. SCOPE This specification defines general requirements for Metallized Polyester Film capacitor MMC type (hereinafter called capacitor).</p> <p>2. PARTS NUMBER CODE SYSTEM</p> <table border="1" data-bbox="231 577 1481 698"> <tr> <td>M</td><td>M</td><td>C</td><td></td> <td>*</td> <td>0</td><td>2</td><td>5</td><td>0</td> <td>J</td> <td>1</td><td>0</td><td>4</td> <td>0</td><td>0</td><td>0</td><td>0</td> <td>0</td><td>0</td><td>0</td><td>0</td> </tr> <tr> <td colspan="4" style="text-align: center;">①</td> <td style="text-align: center;">②</td> <td colspan="4" style="text-align: center;">③</td> <td style="text-align: center;">④</td> <td colspan="3" style="text-align: center;">⑤</td> <td colspan="4" style="text-align: center;">⑥</td> <td colspan="4" style="text-align: center;">⑦</td> </tr> </table> <p>①Designation MMC : Straight lead type MMCF : Single-formed lead type MMCC : Cut lead type MMCV : Automatic vertical insersion type (Formed lead type)</p> <p>②Internal use</p> <p>③Rated DC voltage 250 , 400 , 450 , 630 , 1000 , 1250V.DC</p> <p>④Tolerance on capacitance J : $\pm 5\%$, K : $\pm 10\%$</p> <p>⑤Capacitance Code Capacitance value shall be given by 3-digit figure of which unit used is expressed in pF. The first 2 digits are significant figures of the capacitance value, the third digit to indicate the number of additional zeros to follow the significant figure.</p> <p>⑥Model code (Internal use)</p>			M	M	C		*	0	2	5	0	J	1	0	4	0	0	0	0	0	0	0	0	①				②	③				④	⑤			⑥				⑦			
M	M	C		*	0	2	5	0	J	1	0	4	0	0	0	0	0	0	0	0																								
①				②	③				④	⑤			⑥				⑦																											
<u>REVISIONS</u>	SIGNATURE		DATE																																									
	DESIGNED	<i>H. Takayama</i>	5.23.00																																									
	CHECKED	<i>H. Kawagoe</i>	5.23.00																																									
APPROVED	<i>T. OIKAWA</i>	5.23.00																																										

SPECIFICATION

METALLIZED POLYESTER FILM CAPACITORS

SPEC No.

P S C 3 0 5 0 0 0

⑦Lead dimension / Packing mode

Designation	code			
MMC	0 0 0 0			
MMCF	code	Lead spacing	code	Lead spacing
	0 0 5 0	5.0mm	0 1 5 0	15.0mm
	0 0 7 5	7.5mm	0 1 7 5	17.5mm
	0 1 0 0	10.0mm	0 2 2 5	22.5mm
	0 1 2 5	12.5mm	0 2 7 5	27.5mm
MMCC	0 0 5 0			
MMCV	code	Style		
	0 2 0 0	1 , 5 , 6		
	D 2 0 0	2		
	D 2 1 0	3		

3. RATING

3.1 Operating Temperature Range : Operating temperature range to capacitors shall be $-40^{\circ}\text{C} \sim +105^{\circ}\text{C}$ (Voltage derating in case of over 85°C).

3.1.1 Maximum Operating Temperature : Maximum value of capacitor's surface temperature (ambient temperature + self heating temperature rise + radiation and conduction heat from other electric supply sources) at which capacitors shall be capable of applying continuously.

3.1.2 Minimum Operating Temperature : Minimum temperature range at which capacitors shall be capable of applying continuously.

3.2 Rated Voltage : Rated voltage is defined the voltage which shall be capable of applying to capacitors continuously in the operating temperature range. However, rated voltage shall be derated 1.5% at each 1°C in the range of $+85^{\circ}\text{C} \sim +105^{\circ}\text{C}$ as shown in the Fig. below.

The voltage : 250, 400, 450, 630, 1000, 1250V. DC

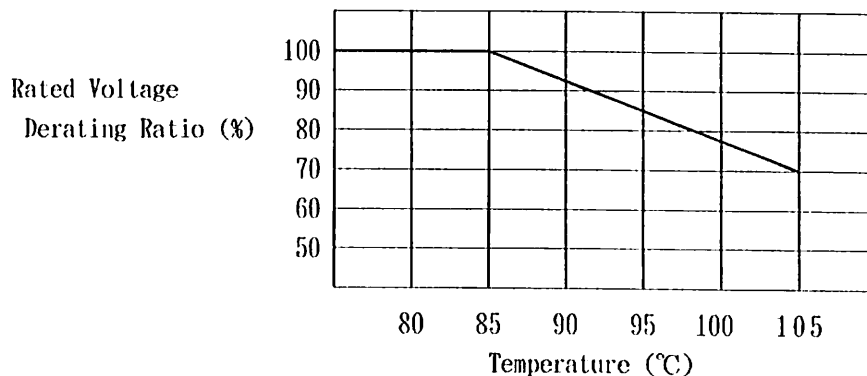

SPECIFICATION

METALLIZED POLYESTER FILM CAPACITOR

SPEC No.

P S C 3 0 5 0 0 0

3.3 Capacitance range

250V. DC	0.0010 ~ 10.0 μ F	E-12
400V. DC	0.0010 ~ 4.7 μ F	E-12
450V. DC	0.0010 ~ 3.3 μ F	E-12
630V. DC	0.0010 ~ 2.2 μ F	E-12
1000V. DC	0.0010 ~ 0.47 μ F	E-12
1250V. DC	0.0010 ~ 0.22 μ F	E-12

3.4 Tolerance on capacitance

 $\pm 5\%$, $\pm 10\%$

4. CONSTRUCTION OF CAPACITOR

Construction shall satisfy the provision of CF922 type of JIS C 5101-1:1998. Capacitor shall be non-inductive wound construction with dielectric of metallized polyester film, and wire lead shall be connected to capacitor element. An exterior coating shall be given dampproofing and insulation treatments by using a flame-retardant epoxy resin (Recognized UL94V-0).

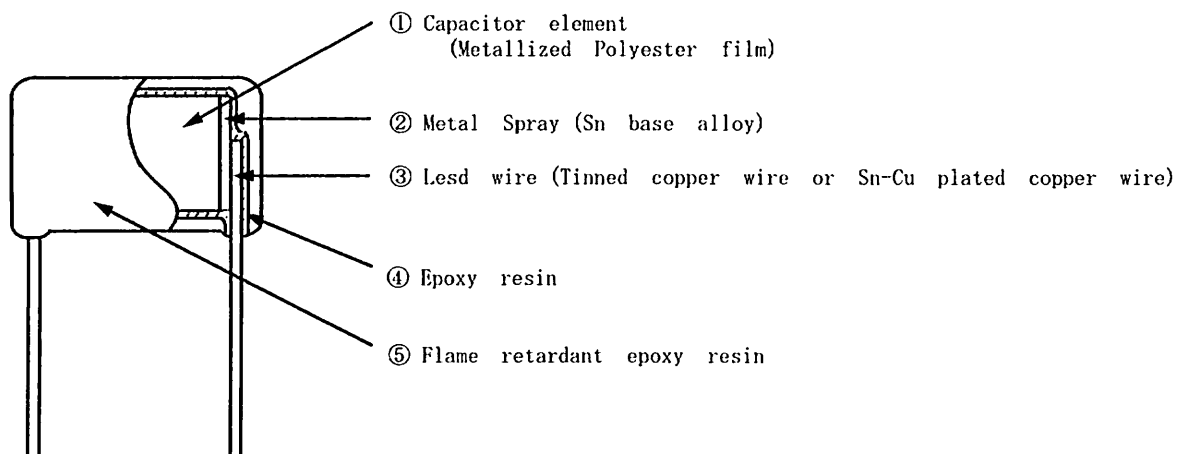

5. DIMENSIONS

Dimensions are specified in the attached sheet.

SPECIFICATION

METALLIZED POLYESTER FILM CAPACITORS

SPEC No.

P S C 3 0 5 0 0 0

6. MARKING

6.1 Marking item

The capacitors shall be marked clearly by an indelible way.

1) Nominal capacitance

Shall be marked with 3-digit code. Example 333, 104

2) Tolerance on capacitance

J or K

3) Production date code

Month year	1	2	3	4	5	6	7	8	9	10	11	12
Odd year	A	B	C	D	E	F	G	H	Φ	Θ	L	Σ
Even year	N	P	Q	R	S	T	U	V	W	X	Y	Z

4) Rated DC voltage

Unit code V is omitted.

5) Manufacturer's Identification

N I S

6.2 Marking position

(Example)

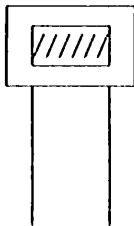

1 0 5 K 2 5 0
N I S A

SPECIFICATION	METALLIZED POLYESTER FILM CAPACITOR	SPEC No. P S C 3 0 5 0 0 0
---------------	-------------------------------------	-------------------------------

7. PACKING

1) Straight leads, formed leads and cutted leads type.

The capacitors shall be put in poly-bag and packed in box marked with necessary information.

Inside packing case

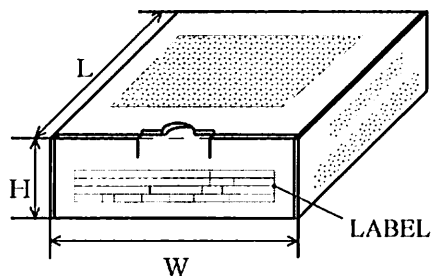

Dimension (mm)

W	L	H
198	176	74

External packing case

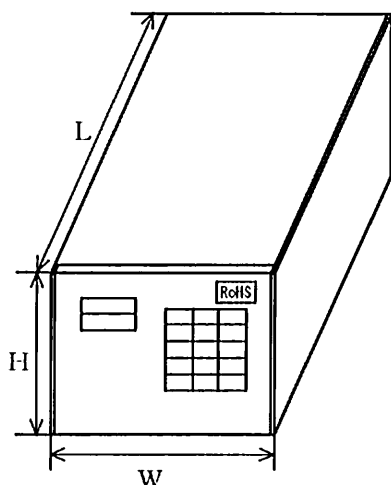

Dimension (mm)

Inside packing case quantity	W	L	H
2	165	210	200
4	210	310	"
6	235	410	"
8	310	410	"
12	410	450	"

Example)

CODE CUSTOMER				INSP DATE		PKG NO	
①				②			
PARTS NO				MACH NO		QTY/PKG	
③				④			
ORDER NO			LOT NO			ROHS	
⑤			⑥			⑦	
TYPE	WV	TOL	CAP	EDP CODE		QT (PCS)	
⑧	⑨	⑩	⑪	⑫		⑬	

- ①CODE CUSTOMER ④MACH NO ⑦PRODUCTION COUNTRY ⑩TOL (%)
- ②INSP DATE ⑤ORDER NO ⑧TYPE ⑪CAP
- ③PARTS NO ⑥LOT NO ⑨W V ⑫EDP CODE
- ⑬QT (PCS)

2) Automatic vertical insertion type.

This is specified by the specification of automatic vertical insertion type.

SPECIFICATION	METALLIZED POLYESTER FILM CAPACITOR	SPEC No. P S C 3 0 5 0 0 0
<p>8. APPLICABLE STANDARD Unless otherwise specified, performance and a testing method shall comply with JIS C 5101-1:1998.</p> <p>9. DISUSE OF O.D.C. No ozone depleting chemicals are used at any stage of the manufacturing process.</p> <p>10. DISUSE OF PBBO, PBDPO, PBDPE, PBBs This products does not contain PBBO, PBDPO, PBDPE, PBBs.</p> <p>11. CERTAIN HAZARDOUS SUBSTANCES RESTRICTED BY RoHS DIRECTIVE In the product, materials to which certain hazardous substances restricted by RoHS Directive (2002/95/EC) (cadmium, hexavalent chromium, mercury, lead, PBB and PBDE) are added on purpose aren't used.</p> <p>12. PRODUCTION COUNTRY <ul style="list-style-type: none"> • JAPAN • CHINA <p>Production country shall be distinguished in the colum ⑦.</p> <p>Example) blank : JAPAN SH : CHINA</p> </p>		

SPECIFICATION	METALLIZED POLYESTER FILM CAPACITOR	SPEC No. P S C 3 0 5 0 0 0
<p>1 3. CHARACTERISTICS AND TEST CONDITIONS</p> <p>13.1 TEST CONDITIONS</p> <p>The test and measurement, unless otherwise specified, the standard range of atmospheric conditions for marking measurements and test is as follows</p> <p style="padding-left: 40px;">Ambient temperature : 5 to 35°C</p> <p style="padding-left: 40px;">Relative humidity : 45 to 85%</p> <p>If there may be anydoubt on the results, measurements shall be made within the following limits,</p> <p style="padding-left: 40px;">Ambient temperature : 20±2°C</p> <p style="padding-left: 40px;">Relative humidity : 60 to 75%</p> <p>13.2 Electrical characteristics test</p>		
Item	Characteristics	Test conditions
Dielectric strength	Between terminations	No breakdown. However momentary breakdown is permissible. Capacitors shall withstand 150% of rated DC voltage for 1 minute or 175% of rated DC voltage for 1~5 seconds. (Charge or discharge current : 1A max)
	Between termination and case	No breakdown. Capacitors shall withstand 200% of rated DC voltage for 1~5 seconds.
Insulation resistance (Between terminations)	$C \leq 0.33 \mu F$ 15,000M Ω or more <hr style="border-top: 1px dashed black;"/> $C > 0.33 \mu F$ 5,000 ΩF or more	DC voltage specified below shall be applied for 1 minute, after which measurement shall be made. Test voltage : 100V.DC
Capacitance	Within the nominal tolerance.	Capacitance shall be measured with 1kHz±20%, 5Vrms max.
Tangent of loss angle	0.008 or less	

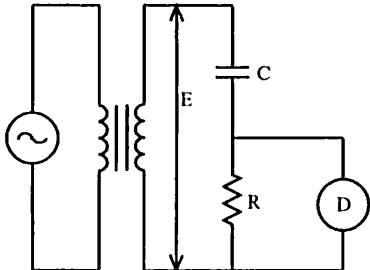
SPECIFICATION		METALLIZED POLYESTER FILM CAPACITOR	SPEC No. P S C 3 0 5 0 0 0
Item	Characteristics	Test conditions	
Connection of element	There shall be no intermittent contacts or open circuiting which would result in any needle deflection on the voltage detector.	<p>As in the diagramed circuit measure the variation of terminal voltage for the series resistor (R) while a weak impact is made on the test capacitor to check the bonding strength of the terminals to the capacitor.</p>  <p>C : Capacitor R : Series resistor R=150 Ω/C (Ω) μF C=Nominal capacitance μF Ⓧ : Detector Internal impedance shall be large enough as compared with c. E : 100mV (peak value) Max at 10k~1MHz</p>	
13.3 Mechanical characteristics test			
Item	Characteristics	Test conditions	
Termination strength	Tensile strength	Test capacitors shall be fixed, and unless otherwise specified, a tensile force of 10N shall be gradually applied to the axial of the leads, and then maintained for 30 ± 5 seconds.	
	Bending strength	Without mechanical damage, such as break of terminal damage.	<p>The bend test shall consist of hanging a weight of 5N to the end of the leads and then rotating the capacitors 90° in one direction, then to the starting point. This test shall be applied for 2.5 seconds per each time.</p> <p>At the same test speed, the capacitors shall be rotated 90° in alternating direction, then return to the starting point.</p>

SPECIFICATION		METALLIZED POLYESTER FILM CAPACITOR		SPEC No. P S C 3 0 5 0 0 0
Item		Characteristics		Test conditions
Vibration resistance		No electrical discontinuity such as opening, short-circuit of 0.5ms or more. Also, no abnormality on appearance after test.		Capacitors shall be capable of withstanding without malfunctioning such as short, open circuit or a damage to a vibration test in three directions against perpendicularity at a frequency range from 10Hz to 55Hz. The frequency shall be varied uniformly from 10Hz to 55Hz at 1.5mm amplitude and back to 10Hz in approximately 1 minute intervals. This test shall be applied 2 hours per each direction, total 6 hours.
Solderability		At least 3/4 of the circumferential face of termination up to immersed level shall be covered with new solder.		Capacitor's leads shall be immersed into Flux (10% rosin) for 5~10 seconds using sheltering board from radial test, then immersed into soldering bath at $230 \pm 5^\circ\text{C}$ for 2 ± 0.5 seconds up to the depth of to the depth of 1.5~2mm from the bottom of the body. Immersed and removing speed shall be 25 ± 2.5 mm/sec.
Resistance to soldering heat	Appearance	No visible damage.		Using sheltering board from the radial heat, capacitor's leads shall be immersed into soldering bath at $260 \pm 5^\circ\text{C}$ for 10 ± 1 seconds up to the depth of 1.5~2mm from the bottom of the body. The capacitors shall withstand 150% of rated DC voltage for 1 minute.
	Dielectric strength (Between terminations)	No breakdown.		
	Capacitance change	Within $\pm 3\%$ of the initial value.		
13.4 Climatic test				
Item		Characteristics		Test conditions
Cold	Capacitance change	Within +0, -7% of the initial value.		Measured at $-40 \pm 2^\circ\text{C}$.
Dry heat	Insulation resistance	$C \leq 0.33 \mu\text{F}$ $900\text{M}\Omega$ or more ----- $C > 0.33 \mu\text{F}$ $300 \Omega \text{ F}$ or more		Measured at $85 \pm 2^\circ\text{C}$.
	Capacitance change	Within +5, -2% of the initial value.		

SPECIFICATION		METALLIZED POLYESTER FILM CAPACITOR	SPEC No. P S C 3 0 5 0 0 0	
Item	Characteristics	Test conditions		
Humidity resistance (steady state)	Appearance	No visible damage.		
	Dielectric strength (Between terminations)	No breakdown.		
	Insulation resistance	$C \leq 0.33 \mu F$ 2,700M Ω or more	The capacitor shall be put into the test chamber and left under the condition of relative humidity 90~95% at $40 \pm 2^\circ C$ for 240 ± 8 hours. After the test, the capacitor shall be left under the ordinally condition for 16 hours. The capacitors shall withstand 130% of rated DC voltage for 1 minutes.	
		$C > 0.33 \mu F$ 900 ΩF or more		
	Tangent of loss angle	0.01 or less		
Capacitance change	Within $\pm 7\%$ of the initial value.			
Endurance test for humidity	Appearance	No visible damage.		
	Dielectric strength (Between terminations)	No breakdown.		
	Insulation resistance	$C \leq 0.33 \mu F$ 2,700M Ω or more	The rated voltage shall be continuously applied to the capacitor in the test chamber at a relative humidity of 90~95% at $40 \pm 2^\circ C$ for 500^{+2}_-4 hours. After the test, the capacitor shall be left under the ordinally condition for 1~2 hours. The capacitors shall withstand 130% of rated DC voltage for 1 minute. The load resistor in series with the capacitor shall be 20~1,000 Ω .	
		$C > 0.33 \mu F$ 900 ΩF or more		
	Tangent of loss angle	0.01 or less		
Capacitance change	Within $\pm 7\%$ of the initial value.			
Endurance test for high temperature	Appearance	No visible damage.		
	Insulation resistance	$C \leq 0.33 \mu F$ 2,700M Ω or more	The voltage of 125% of rated voltage shall be continuously applied to the capacitor through a series of 20~1,000 Ω per 1 voltage in the test chamber at $85 \pm 3^\circ C$ for $1,000^{+4}_-8$ hours.	
		$C > 0.33 \mu F$ 900 ΩF or more		
	Tangent of loss angle	0.01 or less		
Capacitance change	Within $\pm 5\%$ of the initial value.			

SPECIFICATION

METALLIZED POLYESTER FILM CAPACITOR

SPEC No.

P S C 3 0 5 0 0 0

14. SPECIAL STANDARD

For rated voltage 1,000V and 1,250V, special standard described below shall be followed.

14.1 Minimum thickness of the exterior coating

For rated voltage 1,000V and 1,250V, thickness of the exterior coating shall be more than 0.3mm.

The limit of the standard for the exterior coating of capacitors is shown below.

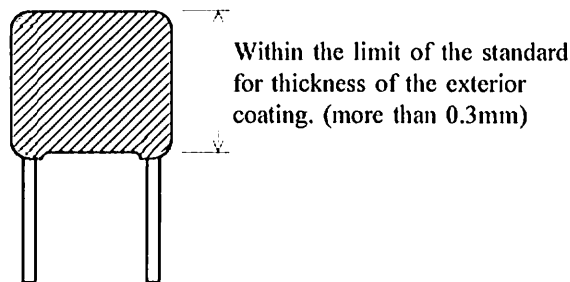

14.2 Damp - proof insulation test :

Capacitors shall be put in 40°C & 90~95%RH for 8 hours and then test at room temperature for 16 hours.

After 5 cycles test, capacitors shall meet the requirements of the following test.

(1) Dielectric Strength

Between terminations : Applied 1,000V.AC for 1 minute.

After the test, there shall be no dielectric breakdown or other damage.

Between termination and case : Applied 1,500V.AC for 1 minute.

After the test, there shall be no dielectric breakdown or other damage.

(2) Insulation resistance

Between terminations : More than 2,000MΩ

Between termination and case : More than 500MΩ

14.3 Dielectric Strength

Between terminations : Applied 1,000V.AC for 1 minute.

After the test, there shall be no dielectric breakdown or other damage.

Between termination and case : Applied 1,500V.AC for 1 minute.

After the test, there shall be no dielectric breakdown or other damage.

SPECIFICATION

METALLIZED POLYESTER FILM CAPACITOR

SPEC No.

P S C 3 0 5 0 0 0

15. REGULATION IN USAGE

15.1 Voltage derating for frequency

15.1.1 A.C. maximum operating voltage in case of operating with commercial frequency (50 or 60Hz) is as shown in the table below. However, it can not be used for "Across-the-line" application.

Rated voltage	A. C. maximum operating voltage
250 V. DC	125 V r m s
400 V. DC	200 V r m s
450 V. DC	200 V r m s
630 V. DC	250 V r m s
1000 V. DC	400 V r m s
1250 V. DC	500 V r m s

15.1.2 When containing a portion of D.C. Bias, the crasy value (peak voltage V_{o-p}) waveform shall not exceed the rated voltage.

15.2 Permissible current to frequency

A permissible current is regulated by both a root-mean-square value current and a peak current. A root-mean-square value current is to be a permissible current value to frequency attached. A permissible peak current is determined by a permissible peak current value attached.

The values of continuous peak current in the allowable peak current shall be those of continuous current, and the values of single peak current shall be those of discontinuous current such as rush current in switching on or off. The highest number of times of single peak current shall be limited to 10,000 times. (In case of exceeding 10,000 times, please contact us.)

15.3 Permissible current to temperature

When operating in the range of $+85^{\circ}\text{C} \sim +105^{\circ}\text{C}$ with waveform except direct current, the value for characteristic of permissible current to frequency shown in Fig. shall be derated 1.5% at each 1°C .

SPECIFICATION

METALLIZED POLYESTER FILM CAPACITOR

SPEC No.

P S C 3 0 5 0 0 0

15.4 Soldering

When soldering a capacitor, heat in soldering is conducted to the elements of the capacitor from lead wire and an enclosure, and hence it should be noted that soldering under high temperature and a long period may cause deterioration of characteristic or breakdown of capacitors.

Be sure to solder within the following temperature condition range.

(1) Flow soldering

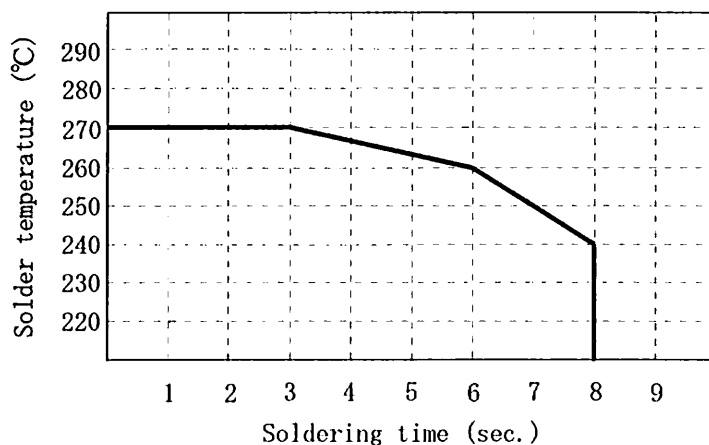

Preheating condition : 120°C,
for 90 seconds

(2) When using soldering iron

Iron tip temperature less than 350°C

Soldering time (sec.) within 5 seconds

(3) When soldering a capacitor mounted on the board with chip-type components

When applying the curing heat for fixing the chip components, the duration for which a capacitor is exposed to heat shall be within the permissible time, which changes according to the ambient temperature of the capacitor as shown in the annex.

周波数に対する許容電流特性 (正弦波)

CHARACTERISTICS OF PERMISSIBLE CURRENT TO FREQUENCY (SINUSOIDAL WAVE)

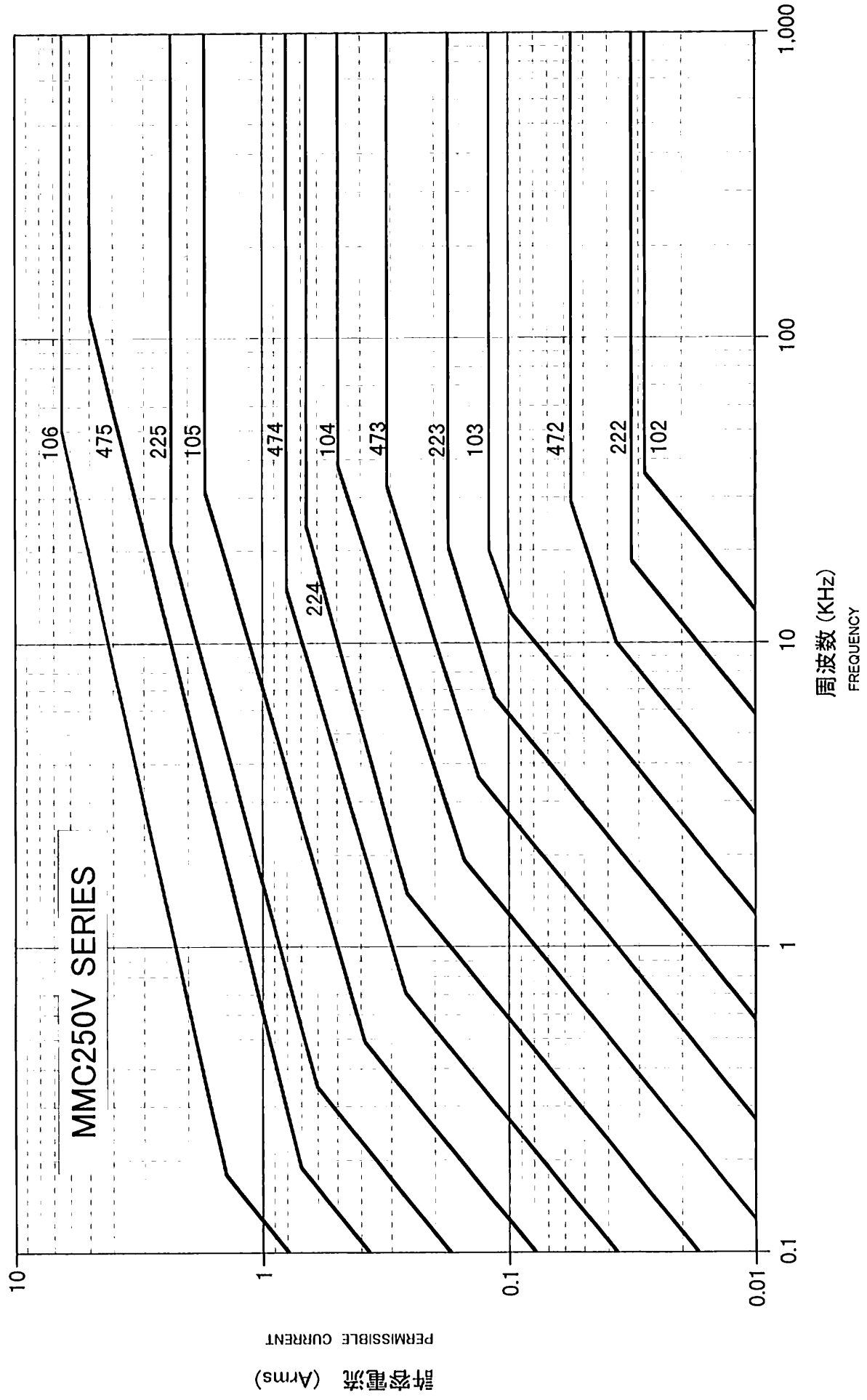

許容電流 (Arms)
PERMISSIBLE CURRENT

周波数 (KHz)
FREQUENCY

周波数に対する許容電流特性 (正弦波)

CHARACTERISTICS OF PERMISSIBLE CURRENT TO FREQUENCY (SINUSOIDAL WAVE)

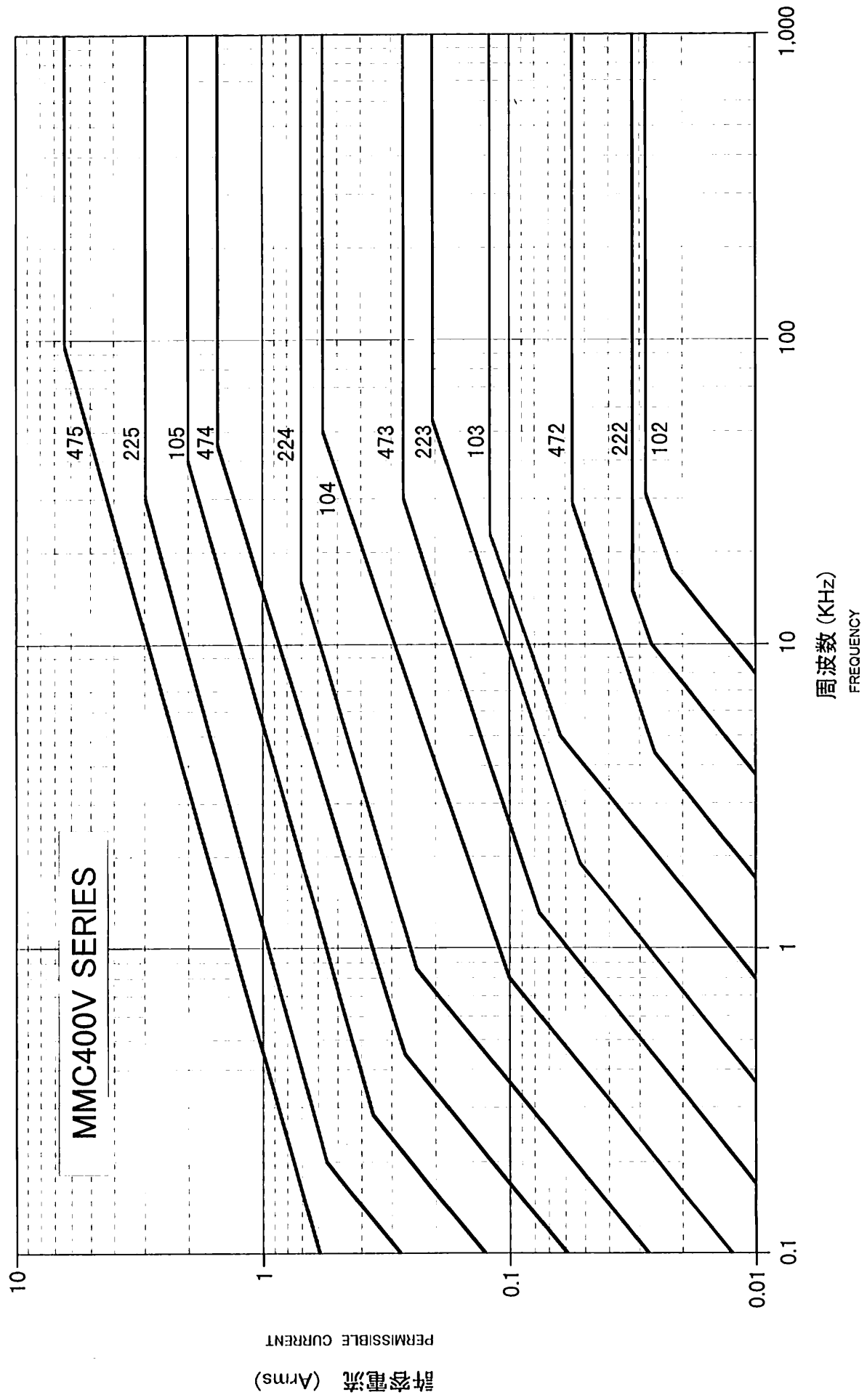

周波数に対する許容電流特性 (正弦波)

CHARACTERISTICS OF PERMISSIBLE CURRENT TO FREQUENCY (SINUSOIDAL WAVE)

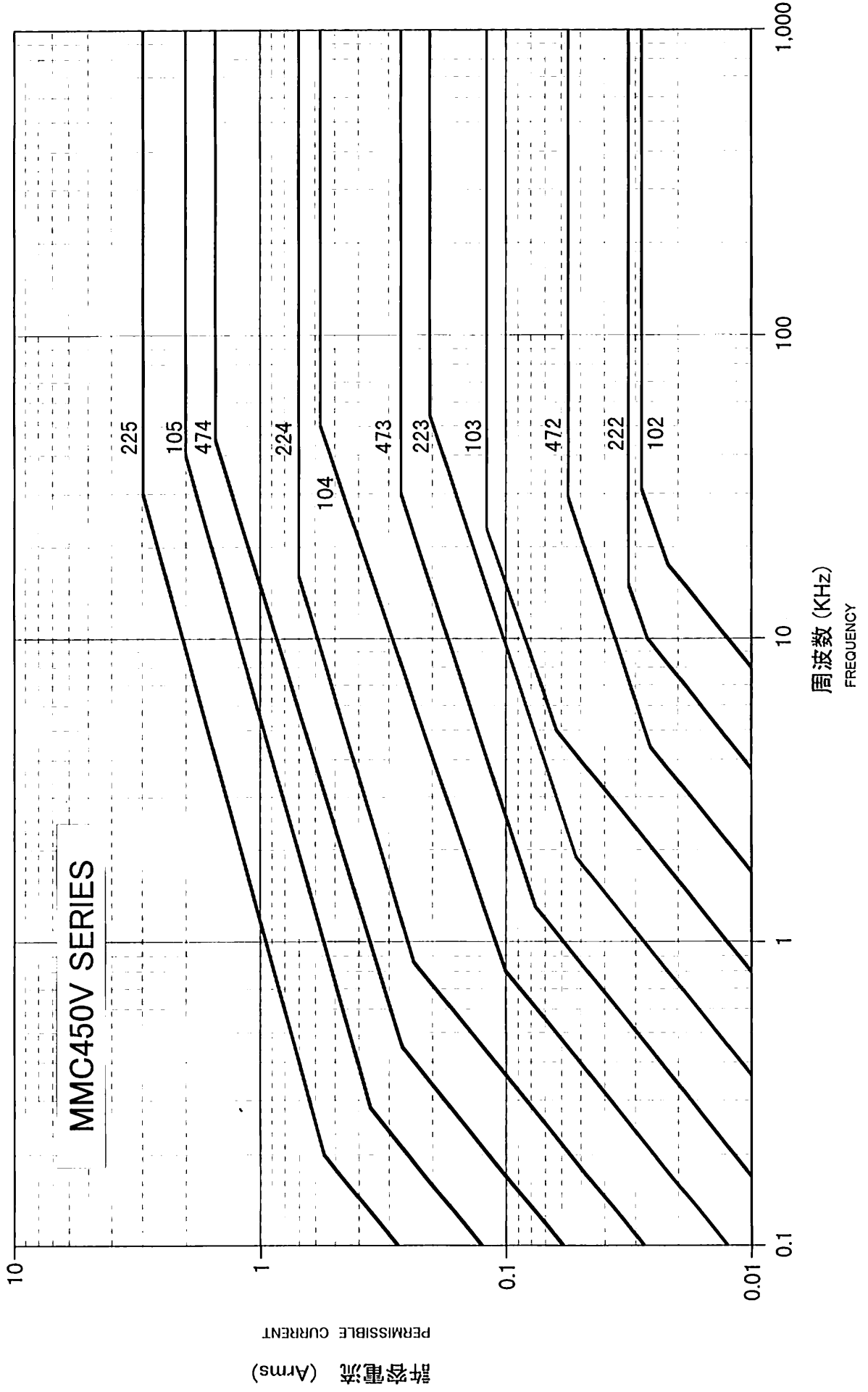

周波数に対する許容電流特性 (正弦波)

CHARACTERISTICS OF PERMISSIBLE CURRENT TO FREQUENCY (SINUSOIDAL WAVE)

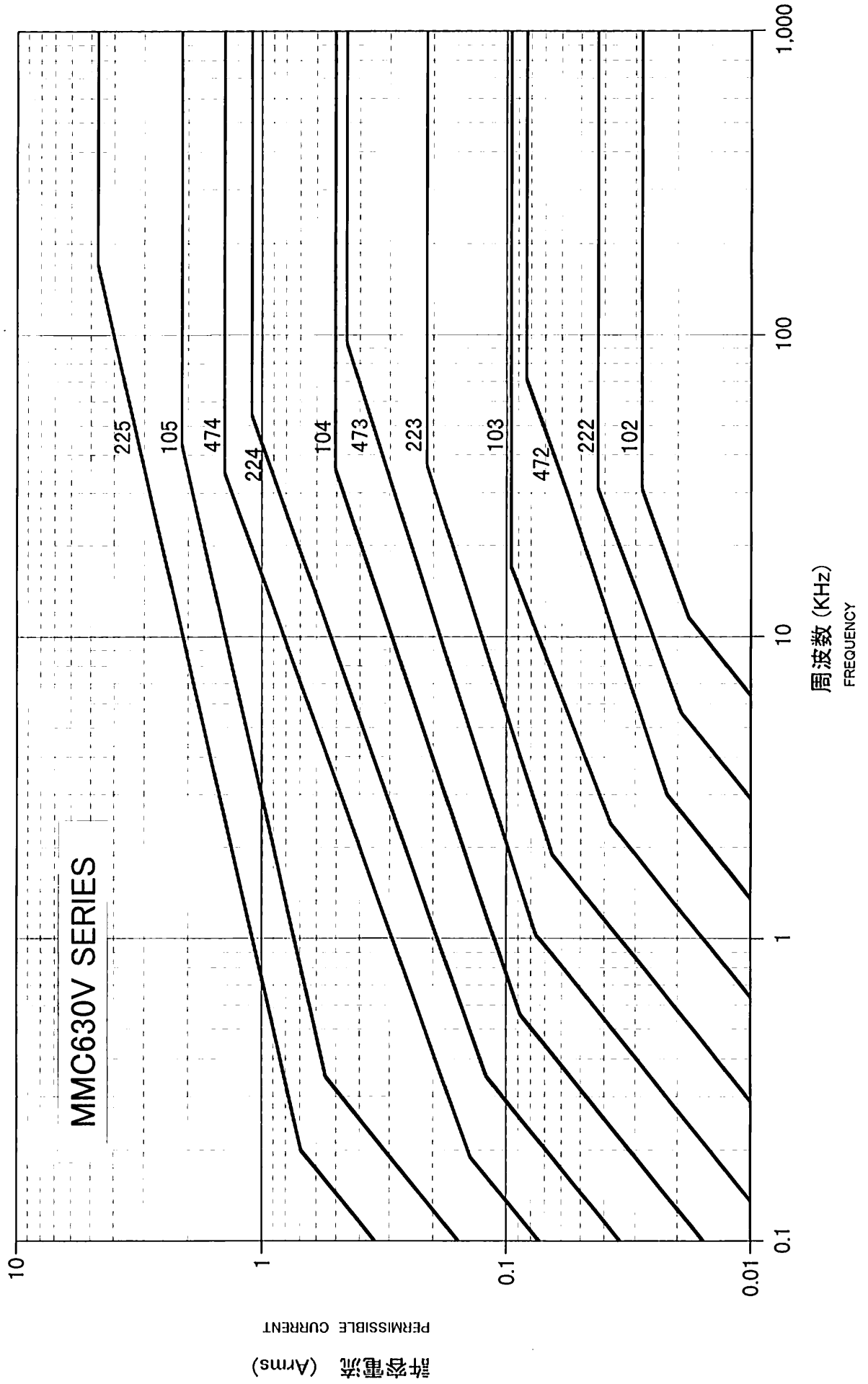

周波数に対する許容電流特性 (正弦波)

CHARACTERISTICS OF PERMISSIBLE CURRENT TO FREQUENCY (SINUSOIDAL WAVE)

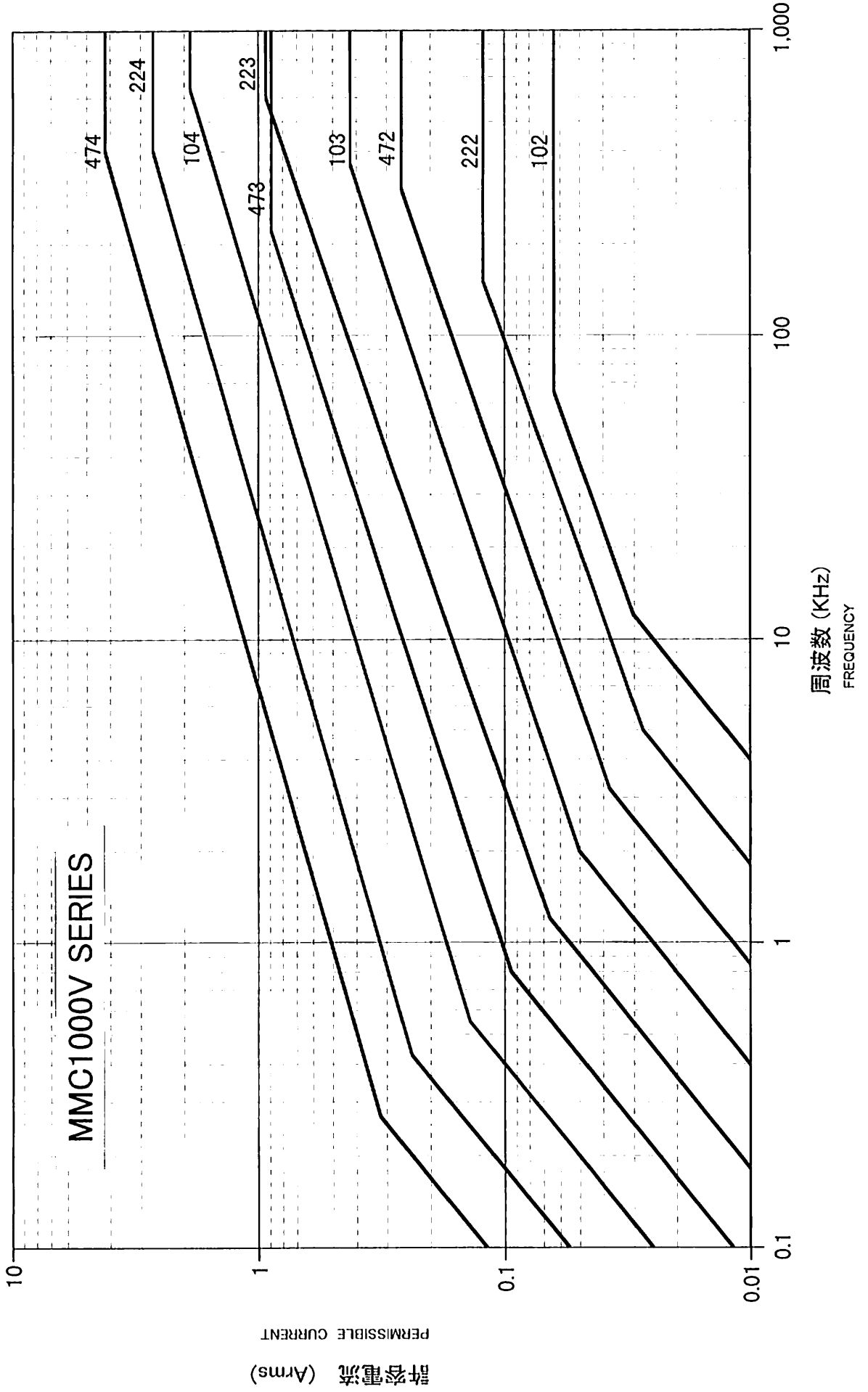

周波数に対する許容電流特性 (正弦波)

CHARACTERISTICS OF PERMISSIBLE CURRENT TO FREQUENCY (SINUSOIDAL WAVE)

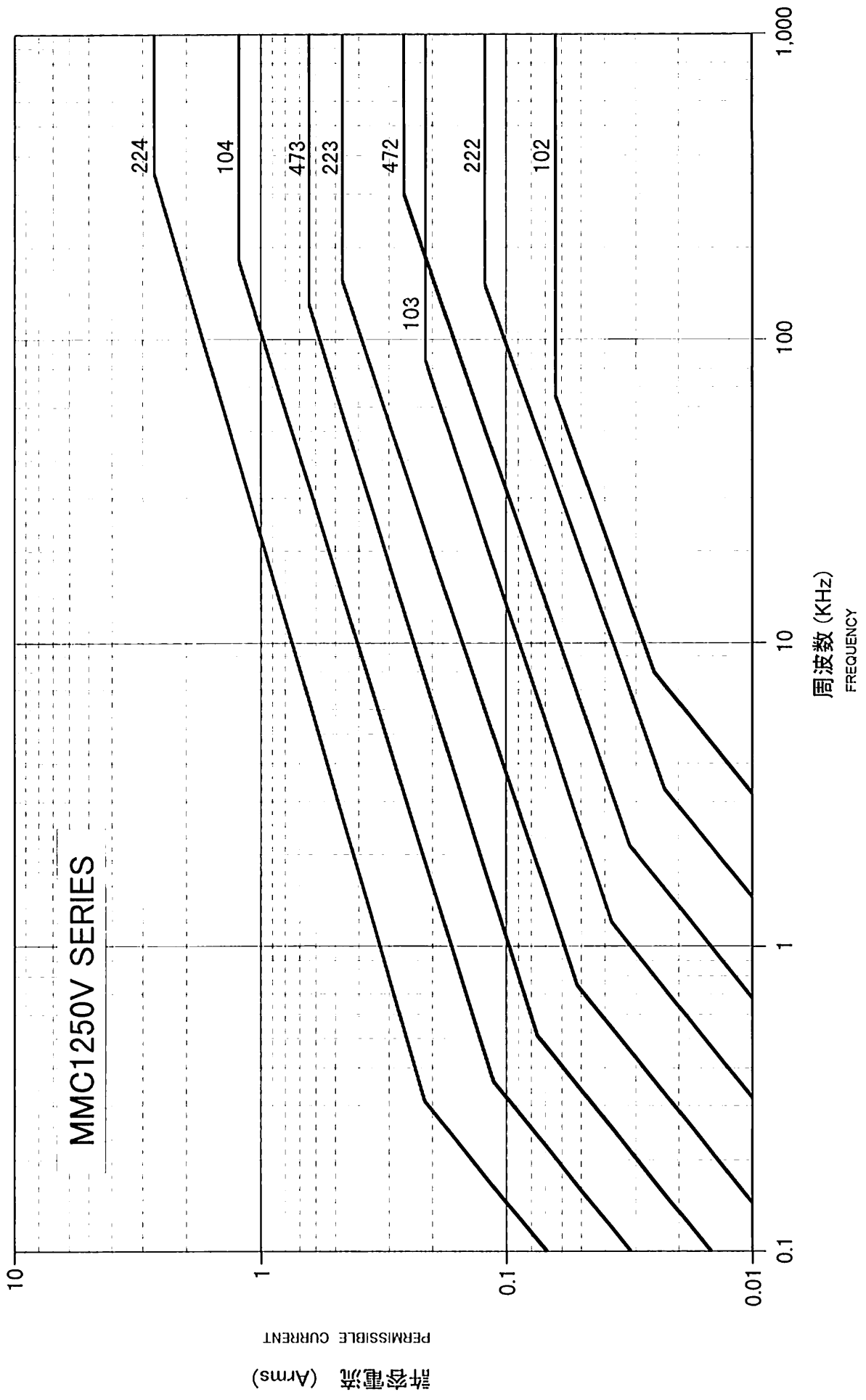

周囲温度による許容さらし時間

Permissible time to be exposed to the ambient temperature

Type: MMC

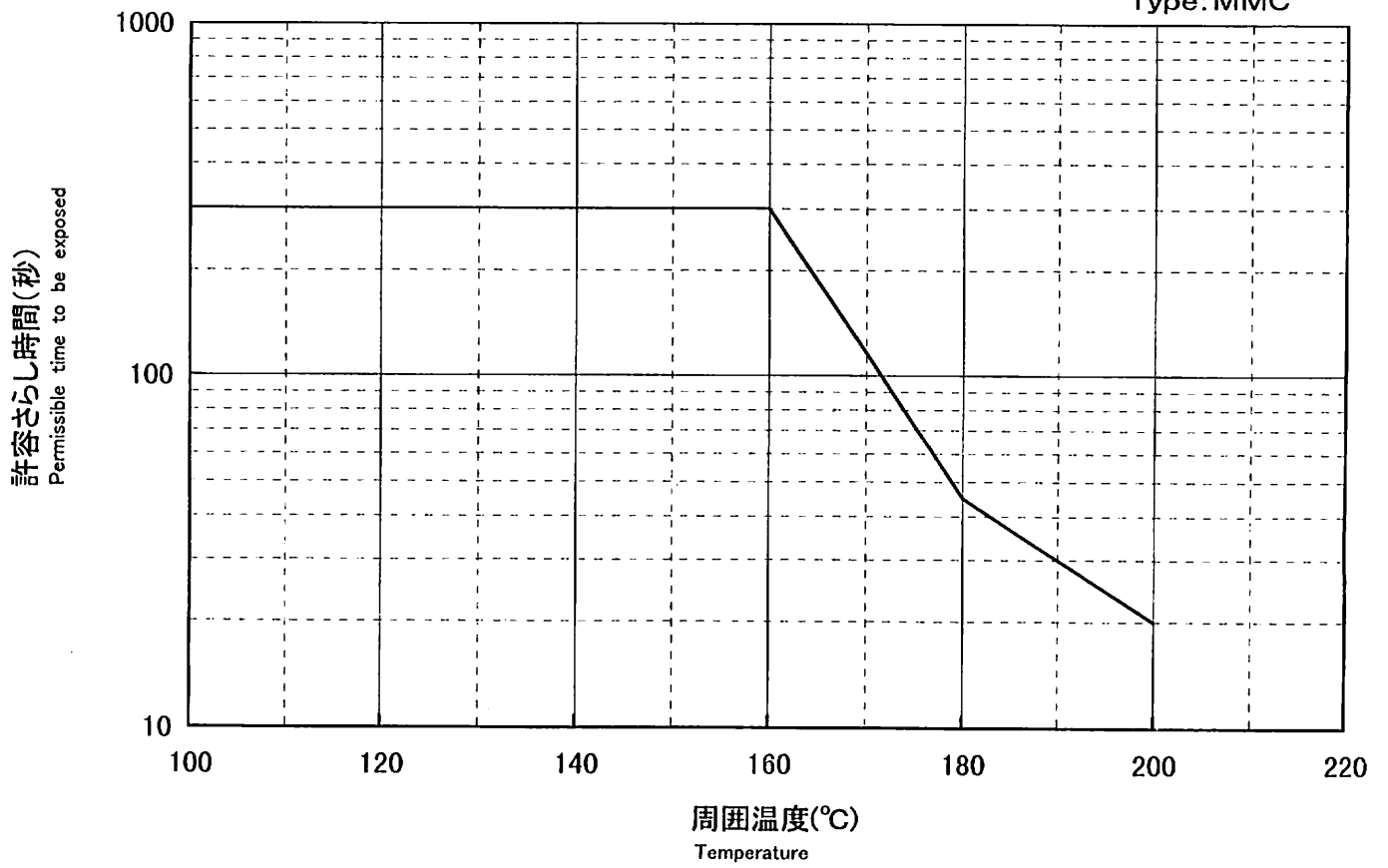

SPECIFICATION

METALLIZED POLYESTER FILM CAPACITORS

SPEC No.

PSC305000

Drawing of dimension

• MMC : Straight lead type

• MMCC : Cut lead type

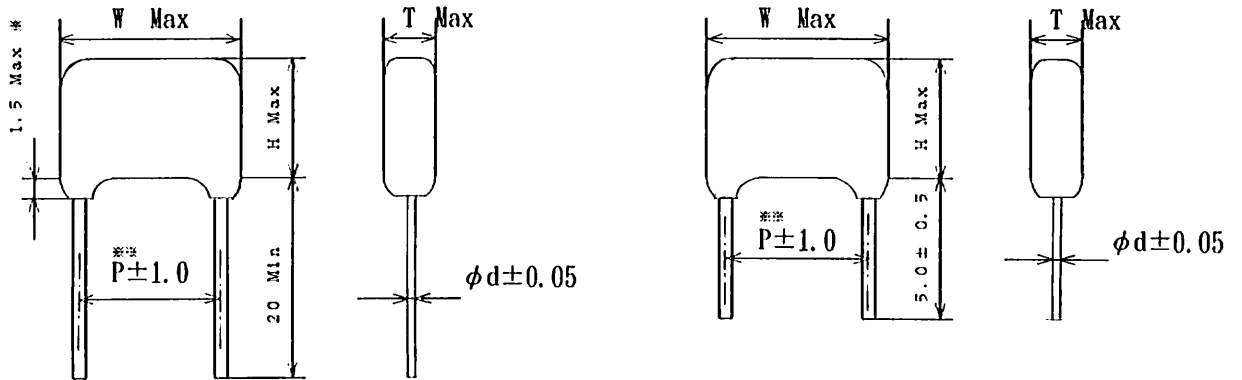

※ 2.0mmMax, when dimension of H are more than 20mm.

※※ 1000, 1250V. DC : P ± 1.5mm

• MMCF : Single-formed lead type

《Type A》

《Type B》

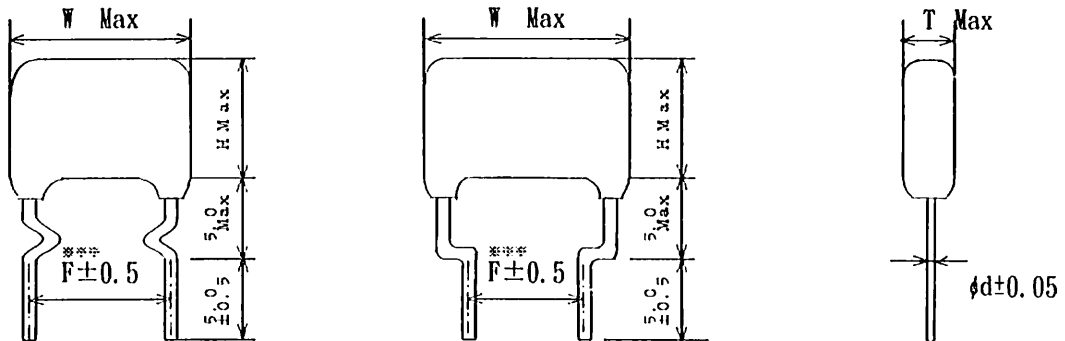

※※※ 1000, 1250V. DC : F ± 0.8mm

SPECIFICATION

METALLIZED POLYESTER FILM CAPACITORS

SPEC No.

PSC305000

MMC, MMCF, MMCC-250V.DC

Parts No.	Capacitance (μ F)	Dimensions (mm)										
		W	H	T	P	F	F	F	F	ϕ d		
MMC□□0250□1020000□□□□	0.0010	10.3	7.0	4.0	7.5	5.0	A	7.5	A		0.6	
MMC□□0250□1220000□□□□	0.0012	"	"	"	"	"	"	"	"		"	
MMC□□0250□1520000□□□□	0.0015	"	"	"	"	"	"	"	"		"	
MMC□□0250□1820000□□□□	0.0018	"	"	"	"	"	"	"	"		"	
MMC□□0250□2220000□□□□	0.0022	"	"	"	"	"	"	"	"		"	
MMC□□0250□2720000□□□□	0.0027	"	"	"	"	"	"	"	"		"	
MMC□□0250□3320000□□□□	0.0033	"	"	"	"	"	"	"	"		"	
MMC□□0250□3920000□□□□	0.0039	"	"	"	"	"	"	"	"		"	
MMC□□0250□4720000□□□□	0.0047	"	"	"	"	"	"	"	"		"	
MMC□□0250□5620000□□□□	0.0056	"	"	"	"	"	"	"	"		"	
MMC□□0250□6820000□□□□	0.0068	"	"	"	"	"	"	"	"		"	
MMC□□0250□8220000□□□□	0.0082	"	"	"	"	"	"	"	"		"	
MMC□□0250□1030000□□□□	0.010	"	7.4	4.3	"	"	"	"	"		"	
MMC□□0250□1230000□□□□	0.012	"	"	4.4	"	"	"	"	"		"	
MMC□□0250□1530000□□□□	0.015	"	7.5	"	"	"	"	"	"		"	
MMC□□0250□1830000□□□□	0.018	"	"	"	"	"	"	"	"		"	
MMC□□0250□2230000□□□□	0.022	"	"	"	"	"	"	"	"		"	
MMC□□0250□2730000□□□□	0.027	"	"	"	"	"	"	"	"		"	
MMC□□0250□3330000□□□□	0.033	"	"	"	"	"	"	"	"		"	
MMC□□0250□3930000□□□□	0.039	"	"	4.5	"	"	"	"	"		"	
MMC□□0250□4730000□□□□	0.047	"	7.9	4.4	"	"	"	"	"		"	
MMC□□0250□5630000□□□□	0.056	"	"	4.8	"	"	"	"	"		"	
MMC□□0250□6830000□□□□	0.068	"	7.5	4.5	"	"	"	"	"		"	
MMC□□0250□8230000□□□□	0.082	"	8.0	4.8	"	"	"	"	"		"	
MMC□□0250□1040000□□□□	0.10	"	8.4	5.8	"	"	"	"	"		"	
MMC□□0250□1240000□□□□	0.12	"	9.0	6.0	"	"	"	"	"		"	
MMC□□0250□1540000□□□□	0.15	"	10.8	"	"	"	"	"	"		"	
MMC□□0250□1840000□□□□	0.18	12.5	10.0	5.0	10.0	"	B	"	"	10.0	A	"
MMC□□0250□2240000□□□□	0.22	"	10.3	5.5	"	"	"	"	"	"	"	"
MMC□□0250□2740000□□□□	0.27	"	11.0	6.0	"	"	"	"	"	"	"	"
MMC□□0250□3340000□□□□	0.33	"	11.5	6.5	"	"	"	"	"	"	"	"
MMC□□0250□3940000□□□□	0.39	18.0	12.0	4.9	15.0	"	"	"	B	15.0	"	"
MMC□□0250□4740000□□□□	0.47	"	12.5	5.3	"	"	"	"	"	"	"	"
MMC□□0250□5640000□□□□	0.56	"	13.0	5.5	"	"	"	"	"	"	"	"
MMC□□0250□6840000□□□□	0.68	"	13.5	6.0	"	"	"	"	"	"	"	0.8
MMC□□0250□8240000□□□□	0.82	"	14.5	6.5	"	"	"	"	"	"	"	"
MMC□□0250□9040000□□□□	0.90	"	"	7.0	"	"	"	"	"	"	"	"

SPECIFICATION	METALLIZED POLYESTER FILM CAPACITORS	SPEC No. P S C 3 0 5 0 0 0
---------------	--------------------------------------	-------------------------------

MMC , MMCF , MMCC - 250 V.DC

Parts No.	Capacitance (μ F)	Dimensions (mm)										
		W	H	T	P	F	F	F	F	A	ϕ d	
MMC□□0250□1050000□□□□	1.0	18.0	15.0	7.4	15.0	5.0	B	7.5	B	15.0	A	0.8
MMC□□0250□1250000□□□□	1.2	"	15.9	8.0	"	"	"	"	"	"	"	"
MMC□□0250□1550000□□□□	1.5	"	16.8	9.0	"			"	"	"	"	"
MMC□□0250□1850000□□□□	1.8	25.0	15.5	7.5	22.5					22.5	"	"
MMC□□0250□2250000□□□□	2.2	"	16.3	8.5	"					"	"	"
MMC□□0250□2750000□□□□	2.7	"	17.1	9.4	"					"	"	"
MMC□□0250□3350000□□□□	3.3	"	18.0	10.3	"					"	"	"
MMC□□0250□3950000□□□□	3.9	"	20.5	11.0	"					"	"	"
MMC□□0250□4750000□□□□	4.7	"	21.5	12.0	"					"	"	"
MMC□□0250□5650000□□□□	5.6	30.0	21.0	11.8	27.5					27.5	"	"
MMC□□0250□6850000□□□□	6.8	"	22.4	13.0	"					"	"	"
MMC□□0250□8250000□□□□	8.2	"	23.5	14.3	"					"	"	"
MMC□□0250□1060000□□□□	10.0	"	25.8	15.9	"					"	"	"

SPECIFICATION

METALLIZED POLYESTER FILM CAPACITORS

SPEC No.

PSC305000

MMC, MMCF, MMCC-400V.DC

Parts No.	Capacitance (μ F)	Dimensions (mm)										
		W	H	T	P	F		F		ϕ d		
MMC□□0400□1020000□□□□	0.0010	10.3	7.0	4.0	7.5	5.0	A	7.5	A		0.6	
MMC□□0400□1220000□□□□	0.0012	"	"	"	"	"	"	"	"		"	
MMC□□0400□1520000□□□□	0.0015	"	"	"	"	"	"	"	"		"	
MMC□□0400□1820000□□□□	0.0018	"	"	"	"	"	"	"	"		"	
MMC□□0400□2220000□□□□	0.0022	"	"	"	"	"	"	"	"		"	
MMC□□0400□2720000□□□□	0.0027	"	"	"	"	"	"	"	"		"	
MMC□□0400□3320000□□□□	0.0033	"	"	"	"	"	"	"	"		"	
MMC□□0400□3920000□□□□	0.0039	"	"	"	"	"	"	"	"		"	
MMC□□0400□4720000□□□□	0.0047	"	"	"	"	"	"	"	"		"	
MMC□□0400□5620000□□□□	0.0056	"	"	"	"	"	"	"	"		"	
MMC□□0400□6820000□□□□	0.0068	"	"	"	"	"	"	"	"		"	
MMC□□0400□8220000□□□□	0.0082	"	"	"	"	"	"	"	"		"	
MMC□□0400□1030000□□□□	0.010	"	7.6	4.4	"	"	"	"	"		"	
MMC□□0400□1230000□□□□	0.012	"	7.8	"	"	"	"	"	"		"	
MMC□□0400□1530000□□□□	0.015	"	"	"	"	"	"	"	"		"	
MMC□□0400□1830000□□□□	0.018	"	7.6	"	"	"	"	"	"		"	
MMC□□0400□2230000□□□□	0.022	"	7.9	4.5	"	"	"	"	"		"	
MMC□□0400□2730000□□□□	0.027	"	8.2	4.8	"	"	"	"	"		"	
MMC□□0400□3330000□□□□	0.033	"	9.0	5.5	"	"	"	"	"		"	
MMC□□0400□3930000□□□□	0.039	12.5	8.0	4.9	10.0	"	B	"	"	10.0	A	"
MMC□□0400□4730000□□□□	0.047	"	8.3	5.2	"	"	"	"	"	"	"	"
MMC□□0400□5630000□□□□	0.056	"	10.0	"	"	"	"	"	"	"	"	"
MMC□□0400□6830000□□□□	0.068	"	10.5	5.5	"	"	"	"	"	"	"	"
MMC□□0400□8230000□□□□	0.082	"	11.0	6.0	"	"	"	"	"	"	"	"
MMC□□0400□1040000□□□□	0.10	"	12.0	"	"	"	"	"	"	"	"	"
MMC□□0400□1240000□□□□	0.12	18.0	10.2	5.5	15.0	"	"	"	B	15.0	"	"
MMC□□0400□1540000□□□□	0.15	"	12.0	"	"	"	"	"	"	"	"	"
MMC□□0400□1840000□□□□	0.18	"	12.5	6.0	"	"	"	"	"	"	"	"
MMC□□0400□2240000□□□□	0.22	"	13.0	6.5	"	"	"	"	"	"	"	"
MMC□□0400□2740000□□□□	0.27	"	13.5	7.0	"	"	"	"	"	"	"	0.8
MMC□□0400□3340000□□□□	0.33	"	14.0	7.7	"	"	"	"	"	"	"	"
MMC□□0400□3940000□□□□	0.39	"	15.0	8.5	"	"	"	"	"	"	"	"
MMC□□0400□4740000□□□□	0.47	"	16.5	"	"	"	"	"	"	"	"	"
MMC□□0400□5640000□□□□	0.56	25.0	15.3	7.5	22.5					22.5	"	"
MMC□□0400□6840000□□□□	0.68	"	16.0	8.2	"					"	"	"
MMC□□0400□8240000□□□□	0.82	"	16.8	9.0	"					"	"	"

SPECIFICATION	METALLIZED POLYESTER FILM CAPACITORS	SPEC No. P S C 3 0 5 0 0 0
---------------	--------------------------------------	-------------------------------

MMC , MMCF , MMCC - 4 0 0 V. D C

Parts No	Capacitance (μ F)	Dimensions (mm)								
		W	H	T	P	F	F	F	ϕ d	
MMC□□0400□1050000□□□□	1.0	25.0	17.7	10.0	22.5			22.5	A	0.8
MMC□□0400□1250000□□□□	1.2	"	18.8	11.0	"			"	"	"
MMC□□0400□1550000□□□□	1.5	30.0	19.5	10.0	27.5			27.5	"	"
MMC□□0400□1850000□□□□	1.8	"	18.7	9.3	"			"	"	"
MMC□□0400□2250000□□□□	2.2	"	19.8	10.4	"			"	"	"
MMC□□0400□2750000□□□□	2.7	"	21.0	11.6	"			"	"	"
MMC□□0400□3350000□□□□	3.3	"	22.3	13.0	"			"	"	"
MMC□□0400□3950000□□□□	3.9	"	23.6	14.2	"			"	"	"
MMC□□0400□4750000□□□□	4.7	"	25.2	15.8	"			"	"	"

SPECIFICATION

METALLIZED POLYESTER FILM CAPACITORS

SPEC No.

P S C 3 0 5 0 0 0

MMC , MMCF , MMCC - 4 5 0 V . D C

Parts No.	Capacitance (μ F)	Dimensions (mm)									
		W	H	T	P	F		F		ϕ d	
MMC□□0450□1020000□□□□	0.0010	10.3	7.0	4.0	7.5	5.0	A	7.5	A		0.6
MMC□□0450□1220000□□□□	0.0012	"	"	"	"	"	"	"	"		"
MMC□□0450□1520000□□□□	0.0015	"	"	"	"	"	"	"	"		"
MMC□□0450□1820000□□□□	0.0018	"	"	"	"	"	"	"	"		"
MMC□□0450□2220000□□□□	0.0022	"	"	"	"	"	"	"	"		"
MMC□□0450□2720000□□□□	0.0027	"	"	"	"	"	"	"	"		"
MMC□□0450□3320000□□□□	0.0033	"	"	"	"	"	"	"	"		"
MMC□□0450□3920000□□□□	0.0039	"	"	"	"	"	"	"	"		"
MMC□□0450□4720000□□□□	0.0047	"	"	"	"	"	"	"	"		"
MMC□□0450□5620000□□□□	0.0056	"	"	"	"	"	"	"	"		"
MMC□□0450□6820000□□□□	0.0068	"	"	"	"	"	"	"	"		"
MMC□□0450□8220000□□□□	0.0082	"	"	"	"	"	"	"	"		"
MMC□□0450□1030000□□□□	0.010	"	7.6	4.4	"	"	"	"	"		"
MMC□□0450□1230000□□□□	0.012	"	7.8	"	"	"	"	"	"		"
MMC□□0450□1530000□□□□	0.015	"	"	"	"	"	"	"	"		"
MMC□□0450□1830000□□□□	0.018	"	7.6	"	"	"	"	"	"		"
MMC□□0450□2230000□□□□	0.022	"	7.9	4.5	"	"	"	"	"		"
MMC□□0450□2730000□□□□	0.027	"	8.2	4.8	"	"	"	"	"		"
MMC□□0450□3330000□□□□	0.033	"	9.0	5.5	"	"	"	"	"		"
MMC□□0450□3930000□□□□	0.039	12.5	8.0	4.9	10.0	"	B	"	"	10.0	A
MMC□□0450□4730000□□□□	0.047	"	8.3	5.2	"	"	"	"	"	"	"
MMC□□0450□5630000□□□□	0.056	"	10.0	"	"	"	"	"	"	"	"
MMC□□0450□6830000□□□□	0.068	"	10.5	5.5	"	"	"	"	"	"	"
MMC□□0450□8230000□□□□	0.082	"	11.0	6.0	"	"	"	"	"	"	"
MMC□□0450□1040000□□□□	0.10	"	12.0	"	"	"	"	"	"	"	"
MMC□□0450□1240000□□□□	0.12	18.0	10.2	5.5	15.0	"	"	"	B	"	"
MMC□□0450□1540000□□□□	0.15	"	12.0	"	"	"	"	"	"	"	"
MMC□□0450□1840000□□□□	0.18	"	12.5	6.0	"	"	"	"	"	15.0	"
MMC□□0450□2240000□□□□	0.22	"	13.0	6.5	"	"	"	"	"	"	"
MMC□□0450□2740000□□□□	0.27	"	13.5	7.0	"	"	"	"	"	"	0.8
MMC□□0450□3340000□□□□	0.33	"	14.0	7.7	"	"	"	"	"	"	"
MMC□□0450□3940000□□□□	0.39	"	15.0	8.5	"	"	"	"	"	"	"
MMC□□0450□4740000□□□□	0.47	"	16.5	"	"	"	"	"	"	"	"
MMC□□0450□5640000□□□□	0.56	25.0	15.3	7.5	22.5					22.5	"
MMC□□0450□6840000□□□□	0.68	"	16.0	8.2	"					"	"
MMC□□0450□8240000□□□□	0.82	"	16.8	9.0	"					"	"

SPECIFICATION

METALLIZED POLYESTER FILM CAPACITORS

SPEC No.

P S C 3 0 5 0 0 0

MMC , MMCF , MMCC - 4 5 0 V . D C

Parts No	Capacitance (μ F)	Dimensions (mm)								
		W	H	T	P	F	F	F	ϕ d	
MMC□□0450□1050000□□□□	1.0	25.0	17.7	10.0	22.5			22.5	A	0.8
MMC□□0450□1250000□□□□	1.2	"	18.8	11.0	"			"	"	"
MMC□□0450□1550000□□□□	1.5	30.0	19.5	10.0	27.5			27.5	"	"
MMC□□0450□1850000□□□□	1.8	"	21.5	11.0	"			"	"	"
MMC□□0450□2250000□□□□	2.2	"	23.0	12.5	"			"	"	"
MMC□□0450□2750000□□□□	2.7	"	25.0	14.0	"			"	"	"
MMC□□0450□3350000□□□□	3.3	"	26.5	15.5	"			"	"	"

SPECIFICATION

METALLIZED POLYESTER FILM CAPACITORS

SPEC No.

P S C 3 0 5 0 0 0

MMC, MMCF, MMCC-630V.DC

Parts No	Capacitance (μ F)	Dimensions (mm)										
		W	H	T	P	F		F		ϕ d		
MMC□□0630□1020000□□□□	0.0010	10.3	7.5	4.5	7.5	5.0	A	7.5	A		0.6	
MMC□□0630□1220000□□□□	0.0012	"	"	"	"	"	"	"	"		"	
MMC□□0630□1520000□□□□	0.0015	"	"	"	"	"	"	"	"		"	
MMC□□0630□1820000□□□□	0.0018	"	"	"	"	"	"	"	"		"	
MMC□□0630□2220000□□□□	0.0022	"	"	"	"	"	"	"	"		"	
MMC□□0630□2720000□□□□	0.0027	"	"	"	"	"	"	"	"		"	
MMC□□0630□3320000□□□□	0.0033	"	"	"	"	"	"	"	"		"	
MMC□□0630□3920000□□□□	0.0039	"	"	"	"	"	"	"	"		"	
MMC□□0630□4720000□□□□	0.0047	"	"	"	"	"	"	"	"		"	
MMC□□0630□5620000□□□□	0.0056	"	"	"	"	"	"	"	"		"	
MMC□□0630□6820000□□□□	0.0068	"	"	"	"	"	"	"	"		"	
MMC□□0630□8220000□□□□	0.0082	"	"	"	"	"	"	"	"		"	
MMC□□0630□1030000□□□□	0.010	12.5	"	4.0	10.0	"	B	"	"	10.0	A	"
MMC□□0630□1230000□□□□	0.012	"	"	4.5	"	"	"	"	"	"	"	"
MMC□□0630□1530000□□□□	0.015	"	8.2	5.0	"	"	"	"	"	"	"	"
MMC□□0630□1830000□□□□	0.018	"	10.0	"	"	"	"	"	"	"	"	"
MMC□□0630□2230000□□□□	0.022	"	10.5	5.3	"	"	"	"	"	"	"	"
MMC□□0630□2730000□□□□	0.027	"	"	5.5	"	"	"	"	"	"	"	"
MMC□□0630□3330000□□□□	0.033	"	11.0	6.0	"	"	"	"	"	"	"	"
MMC□□0630□3930000□□□□	0.039	"	12.5	"	"	"	"	"	"	"	"	"
MMC□□0630□4730000□□□□	0.047	"	13.0	6.5	"	"	"	"	"	"	"	"
MMC□□0630□5630000□□□□	0.056	18.0	10.5	5.5	15.0	"	"	"	B	15.0	"	"
MMC□□0630□6830000□□□□	0.068	"	11.0	6.0	"	"	"	"	"	"	"	"
MMC□□0630□8230000□□□□	0.082	"	11.5	6.5	"	"	"	"	"	"	"	"
MMC□□0630□1040000□□□□	0.10	"	13.0	"	"	"	"	"	"	"	"	"
MMC□□0630□1240000□□□□	0.12	"	13.5	7.0	"	"	"	"	"	"	"	0.8
MMC□□0630□1540000□□□□	0.15	"	14.5	8.0	"	"	"	"	"	"	"	"
MMC□□0630□1840000□□□□	0.18	"	16.0	"	"	"	"	"	"	"	"	"
MMC□□0630□2240000□□□□	0.22	"	16.5	9.0	"	"	"	"	"	"	"	"
MMC□□0630□2740000□□□□	0.27	25.0	16.8	7.5	22.5					22.5	"	"
MMC□□0630□3340000□□□□	0.33	"	17.5	8.0	"					"	"	"
MMC□□0630□3940000□□□□	0.39	"	18.0	8.7	"					"	"	"
MMC□□0630□4740000□□□□	0.47	"	19.0	9.5	"					"	"	"
MMC□□0630□5640000□□□□	0.56	"	20.0	10.5	"					"	"	"
MMC□□0630□6840000□□□□	0.68	"	21.5	11.5	"					"	"	"
MMC□□0630□8240000□□□□	0.82	30.0	20.0	10.5	27.5					27.5	"	"

SPECIFICATION

METALLIZED POLYESTER FILM CAPACITORS

SPEC No.

P S C 3 0 5 0 0 0

MMC , MMCF , MMCC - 6 3 0 V. D C

Parts No	Capacitance (μ F)	Dimensions (mm)									
		W	H	T	P	F	F	F	ϕ d		
MMC□□0630□1050000□□□□	1.0	30.0	21.0	11.5	27.5				27.5	A	0.8
MMC□□0630□1250000□□□□	1.2	"	22.0	12.5	"				"	"	"
MMC□□0630□1550000□□□□	1.5	"	24.0	14.3	"				"	"	"
MMC□□0630□1850000□□□□	1.8	"	25.5	15.5	"				"	"	"
MMC□□0630□2250000□□□□	2.2	"	27.3	17.5	"				"	"	"

SPECIFICATION	METALLIZED POLYESTER FILM CAPACITOR	SPEC No. P S C 3 0 5 0 0 0
---------------	-------------------------------------	-------------------------------

MMC, MMCF, MMCC-1000V. DC

Parts No.	Capacitance (μ F)	Dimensions (mm)						
		W	H	T	P	F	ϕ d	
MMC□□1000□1020000□□□□□	0.0010	15.5	11.0	6.0	12.5	10.0	Λ	0.6
MMC□□1000□1220000□□□□□	0.0012	"	"	"	"	"	"	"
MMC□□1000□1520000□□□□□	0.0015	"	"	"	"	"	"	"
MMC□□1000□1820000□□□□□	0.0018	"	"	"	"	"	"	"
MMC□□1000□2220000□□□□□	0.0022	"	11.5	"	"	"	"	"
MMC□□1000□2720000□□□□□	0.0027	"	12.0	6.5	"	"	"	"
MMC□□1000□3320000□□□□□	0.0033	"	11.5	6.0	"	"	"	"
MMC□□1000□3920000□□□□□	0.0039	"	12.0	6.5	"	"	"	"
MMC□□1000□4720000□□□□□	0.0047	"	12.5	7.0	"	"	"	"
MMC□□1000□5620000□□□□□	0.0056	"	13.0	7.5	"	"	"	"
MMC□□1000□6820000□□□□□	0.0068	"	11.0	6.0	"	"	"	"
MMC□□1000□8220000□□□□□	0.0082	"	"	"	"	12.5	"	"
MMC□□1000□1030000□□□□□	0.010	"	"	"	"	"	"	"
MMC□□1000□1230000□□□□□	0.012	"	12.0	"	"	"	"	"
MMC□□1000□1530000□□□□□	0.015	"	12.5	7.0	"	"	"	"
MMC□□1000□1830000□□□□□	0.018	"	13.0	7.5	"	"	"	0.8
MMC□□1000□2230000□□□□□	0.022	"	15.5	"	"	"	"	"
MMC□□1000□2730000□□□□□	0.027	21.0	13.0	6.0	17.5	"	Β	"
MMC□□1000□3330000□□□□□	0.033	"	14.0	6.5	"	"	"	"
MMC□□1000□3930000□□□□□	0.039	"	14.5	7.0	"	"	"	"
MMC□□1000□4730000□□□□□	0.047	"	15.5	7.5	"	"	"	"
MMC□□1000□5630000□□□□□	0.056	"	17.0	"	"	"	"	"
MMC□□1000□6830000□□□□□	0.068	"	18.0	8.5	"	"	"	"
MMC□□1000□8230000□□□□□	0.082	"	18.5	9.0	"	"	"	"
MMC□□1000□1040000□□□□□	0.10	"	20.0	10.0	"	"	"	"
MMC□□1000□1240000□□□□□	0.12	26.0	18.5	9.0	22.5	17.5	"	"
MMC□□1000□1540000□□□□□	0.15	"	20.0	10.0	"	"	"	"
MMC□□1000□1840000□□□□□	0.18	"	22.0	10.5	"	"	"	"
MMC□□1000□2240000□□□□□	0.22	"	23.0	12.0	"	"	"	"
MMC□□1000□2740000□□□□□	0.27	"	25.0	13.5	"	"	"	"
MMC□□1000□3340000□□□□□	0.33	31.0	24.0	13.0	27.5	22.5	"	"
MMC□□1000□3940000□□□□□	0.39	"	26.0	14.0	"	"	"	"
MMC□□1000□4740000□□□□□	0.47	"	27.5	15.5	"	"	"	"

SPECIFICATION

METALLIZED POLYESTER FILM CAPACITORS

SPEC No.

P S C 3 0 5 0 0 0

MMC , MMCF , MMCC - 1 2 5 0 V . D C

Parts No.	Capacitance (μ F)	Dimensions (mm)						ϕ d
		W	H	T	P	F		
MMC□□1250□1020000□□□□	0.0010	15.5	11.0	6.0	12.5	10.0	A	0.6
MMC□□1250□1220000□□□□	0.0012	"	"	"	"	"	"	"
MMC□□1250□1520000□□□□	0.0015	"	"	"	"	"	"	"
MMC□□1250□1820000□□□□	0.0018	"	"	"	"	"	"	"
MMC□□1250□2220000□□□□	0.0022	"	11.5	"	"	"	"	"
MMC□□1250□2720000□□□□	0.0027	"	12.0	6.5	"	"	"	"
MMC□□1250□3320000□□□□	0.0033	"	11.5	6.0	"	"	"	"
MMC□□1250□3920000□□□□	0.0039	"	12.0	6.5	"	"	"	"
MMC□□1250□4720000□□□□	0.0047	"	12.5	7.0	"	"	"	"
MMC□□1250□5620000□□□□	0.0056	"	13.0	7.5	"	"	"	"
MMC□□1250□6820000□□□□	0.0068	"	15.0	"	"	"	"	"
MMC□□1250□8220000□□□□	0.0082	21.0	12.0	5.0	17.5	12.5	B	"
MMC□□1250□1030000□□□□	0.010	"	12.5	"	"	"	"	"
MMC□□1250□1230000□□□□	0.012	"	13.0	5.5	"	"	"	"
MMC□□1250□1530000□□□□	0.015	"	13.5	6.0	"	"	"	"
MMC□□1250□1830000□□□□	0.018	"	14.5	6.5	"	"	"	0.8
MMC□□1250□2230000□□□□	0.022	"	15.0	7.0	"	"	"	"
MMC□□1250□2730000□□□□	0.027	26.0	15.5	6.0	22.5	17.5	"	"
MMC□□1250□3330000□□□□	0.033	"	16.0	6.5	"	"	"	"
MMC□□1250□3930000□□□□	0.039	"	16.5	7.0	"	"	"	"
MMC□□1250□4730000□□□□	0.047	"	17.0	8.0	"	"	"	"
MMC□□1250□5630000□□□□	0.056	31.0	"	7.5	27.5	22.5	"	"
MMC□□1250□6830000□□□□	0.068	"	17.5	8.0	"	"	"	"
MMC□□1250□8230000□□□□	0.082	"	18.5	9.0	"	"	"	"
MMC□□1250□1040000□□□□	0.10	"	19.5	10.0	"	"	"	"
MMC□□1250□1240000□□□□	0.12	"	20.5	11.5	"	"	"	"
MMC□□1250□1540000□□□□	0.15	"	23.0	12.0	"	"	"	"
MMC□□1250□1840000□□□□	0.18	"	24.5	13.0	"	"	"	"
MMC□□1250□2240000□□□□	0.22	"	26.5	14.5	"	"	"	"

SPECIFICATION

METALLIZED POLYESTER FILM CAPACITOR

SPEC No.

P S C 3 0 5 0 0 0

SPECIFICATION OF TAPING FOR AUTOMATIC INSERTION (Type MMCV)

1. SCOPE

This specification applies to the taping dimensions and performance required for film capacitors used in the automatic radial insertion system.

Style of packing : Ammo pack

2. TAPING DIMENSIONS

Type	Taping style	STYLE-1	STYLE-2	STYLE-3	STYLE-5	STYLE-6
	Rated Voltage					
MMCV	250V, DC	102~154	184~334	394~125	184~334	394~155
	400V, DC	102~333	393~104	124~474	393~104	124~474
	450V, DC	102~333	393~104	124~474	393~104	124~474
	630V, DC	102~822	103~473	563~224	103~473	563~224

3. TAPING PERFORMANCE (to be satisfied with the following point)

3-1. Appearance : To be no damages or cracks on components and the tape.

3-2. Missing components : A maximum of 3 consecutive components may be missing.

3-3. Tip of the tape : To leave the blank tape more than 4.5 feed hole pitch from the start, and the end of the tape.

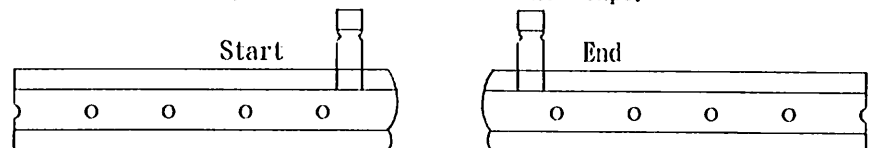

3-4. Tape splicing : Tape splicing may be done with (1) or (2).

(1) The carrier tape (include hold-down tape) shall be cut at the center of hole and hole, and spliced with tape.

(2) The carrier tape (include hold down tape) shall be cut at the center of hole, and spliced with splicing tape.

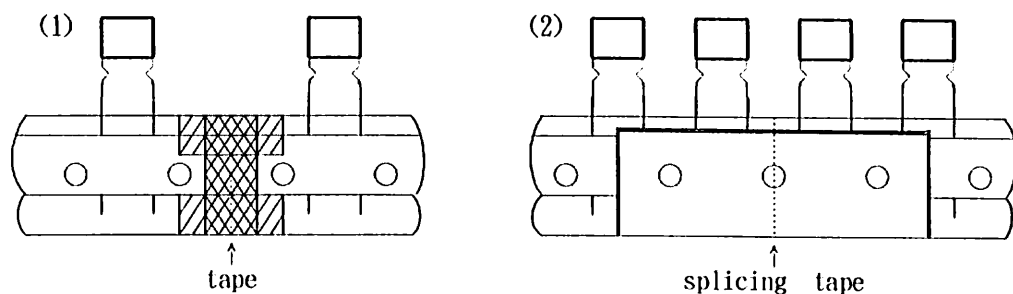

SPECIFICATION

METALLIZED POLYESTER FILM CAPACITORS

SPEC No.

P S C 3 0 5 0 0 0

3-5. Adhesive strength : When pulling an adhesive tape in \uparrow direction (upward) using a push-and-pull scale, adhesive strength shall be 3N or more.

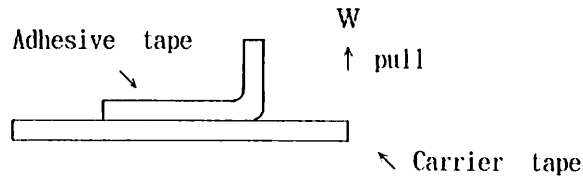

3-6. Tensile test : When pulling a test sample by the force 10N, there shall be no gaps or breakdowns.

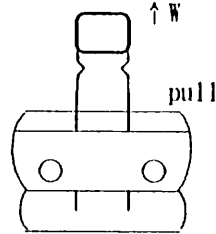

3-7. Moisture resistance test : A taped test sample shall be left in a chamber with a temperature of 40°C and RH95% for 96 hours. Then after being left for one hour at room temperature, the test sample shall be submitted to a tensile test of item 3.6.

3-8. Temperature cycling test : A test sample shall be submitted to 5 cycles of temperature cycling test.

One cycle consists of : 2 hours at -40°C

2 hours at +85°C

Then after being left for one hour at room temperature, the test sample shall be submitted to a tensile test of item 3.6.

4. BOX DIMENSIONS

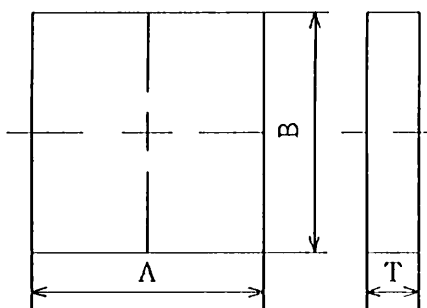

(unit : mm)

Type	A	B	T
c	330±7	330±7	45±5
d	330±7	330±7	50±5
e	330±7	330±7	55±5

SPECIFICATION

METALLIZED POLYESTER FILM CAPACITOR

SPEC No.

P S C 3 0 5 0 0 0

5. STYLE OF PACKING (Ammo pack)

5-1. Packaging

- * Fold the tape in the cardboard box, with hold-down tepe turning up against an outlet opening.
- * Thread the feed hole with a axle and fix the tape.

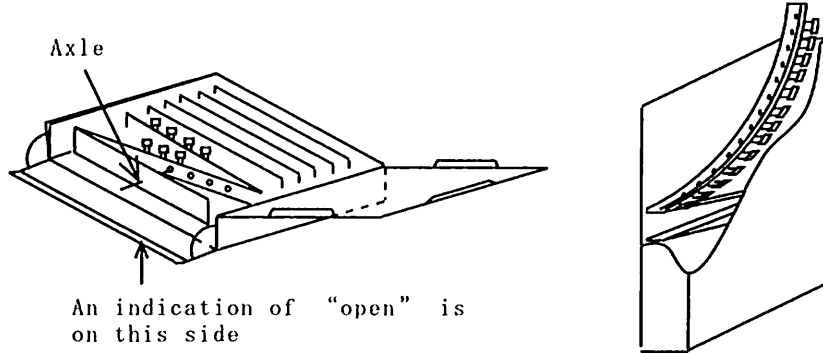

5-2. Marking

The following particulars shall be labelled on the surface of a box.

Example)

CODE CUSTOMER				INSP DATE		PKG NO	
PARTS NO				MACH NO		QTY/PKG	
ORDER NO			LOT NO			ROHS	
TYPE		WV	TOL	CAP	EDP CODE		QT (PCS)

- ①CODE CUSTOMER ④MACH NO ⑦PRODUCTION COUNTRY ⑩TOL (%)
- ②INSP DATE ⑤ORDER NO ⑧TYPE ⑪CAP
- ③PARTS NO ⑥LOT NO ⑨W V ⑫EDP CODE
- ⑬QT (PCS)

		SPEC No.
SPECIFICATION	METALLIZED POLYESTER FILM CAPACITORS	PSC305000

Type MMCV	102 ~ 154	250V. DC
STYLE - 1	102 ~ 333	400V. DC
	102 ~ 333	450V. DC
	102 ~ 822	630V. DC

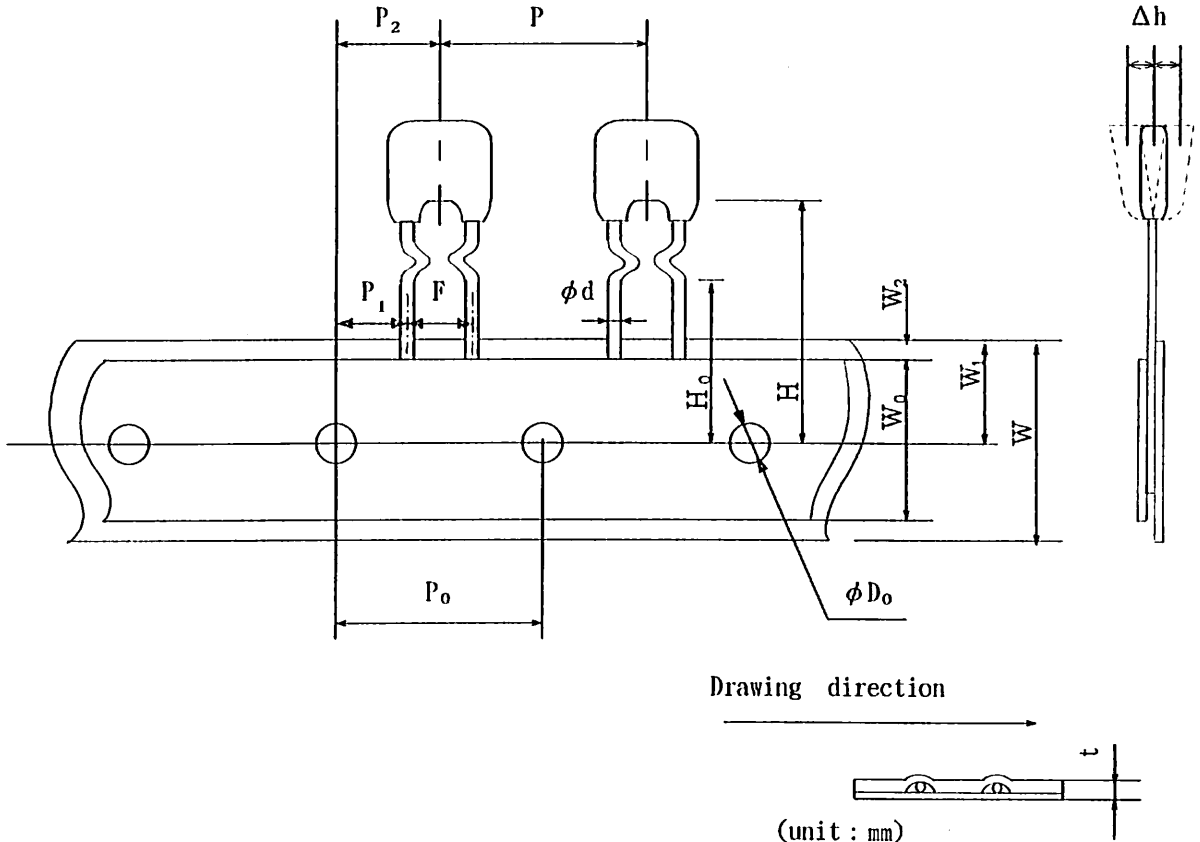

(unit : mm)

P	P_0	(1) P_1	P_2	ϕd	(1) F	(2) Δh	W	W_0	W_1	(3) W_2	H	(1) H_0	ϕD_0	t
12.7	12.7	3.85	6.35	0.6	5.0	0	18.0	≥ 5.0	9.0	3.0 Max	21.25 Max	16.0	4.0	0.7
± 1.0	± 0.3	± 0.7	± 1.3	± 0.05	± 0.8 ± 0.2	± 2.0	± 1.0 ± 0.5	—	± 0.5	—	—	± 0.5	± 0.2	± 0.2

- (1) To be measured under the clinch-position.
- (2) To be measured the top of component.
- (3) Hold-down tape is not to exceed over the carrier tape.

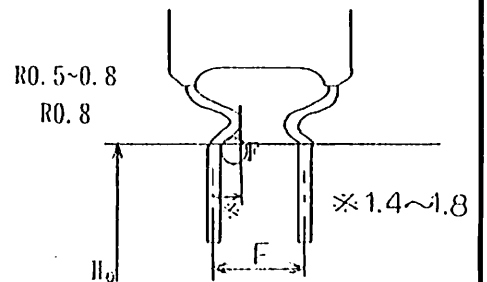

SPECIFICATION

METALLIZED POLYESTER FILM CAPACITORS

SPEC No.

PSC305000

Type MMCV	184 ~ 334	250V. DC
STYLE - 2	393 ~ 104	400V. DC
	393 ~ 104	450V. DC
	103 ~ 473	630V. DC

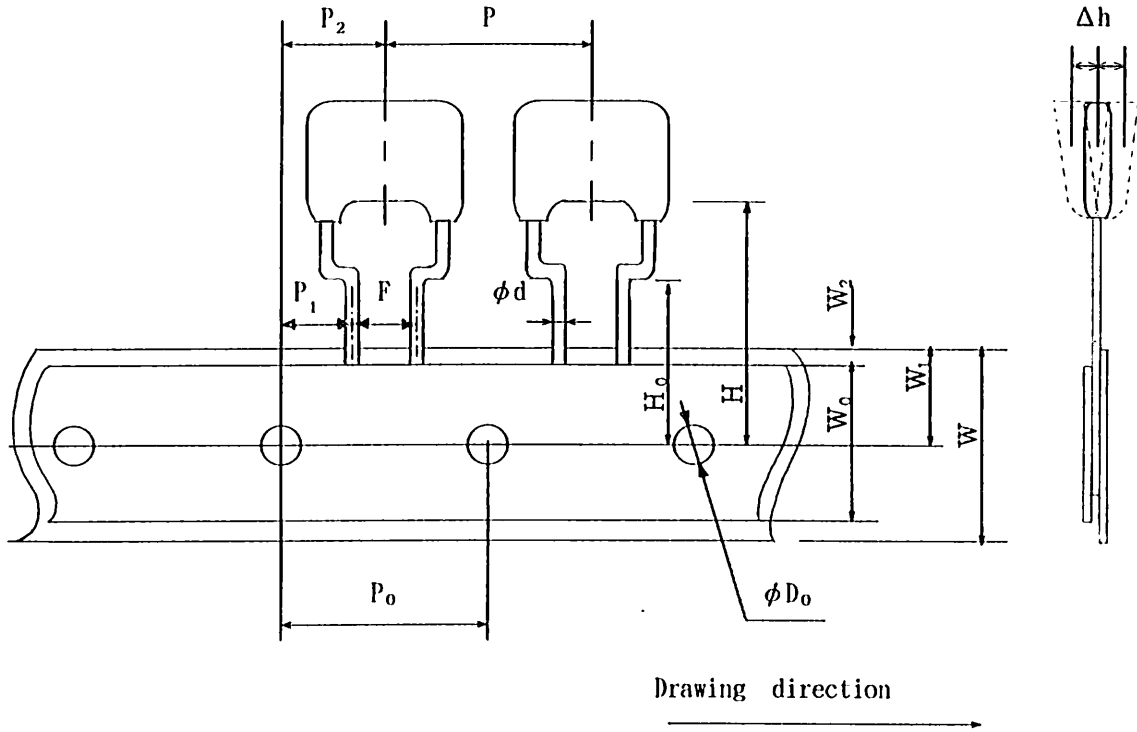

(unit : mm)

P	P ₀	(1) P ₁	P ₂	φ d	(1) F	(2) Δ h	W	W ₀	W ₁	(3) W ₂	H	(1) H ₀	φ D ₀	t
15.0	15.0	5.0	7.5	0.6 or 0.8	5.0	0	18.0	≥ 5.0	9.0	3.0 Max	22.0 Max	16.0	4.0	0.7
±1.0	±0.3	±0.7	±1.3	±0.05	±0.8 ±0.2	±2.0	±1.0 ±0.5	—	±0.5	—	—	±0.5	±0.2	±0.2

- (1) To be measured under the clinch-position.
- (2) To be measured the top of component.
- (3) Hold-down tape is not to exceed over the carrire tape.

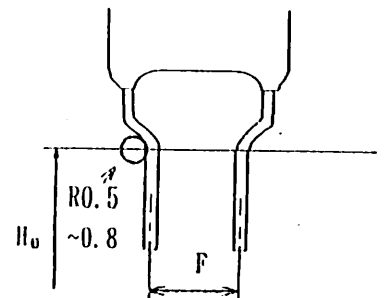

SPECIFICATION

METALLIZED POLYESTER FILM CAPACITORS

SPEC No.

P S C 3 0 5 0 0 0

Type MMCV	394 ~ 125	250V. DC
STYLE - 3	124 ~ 474	400V. DC
	124 ~ 474	450V. DC
	563 ~ 224	630V. DC

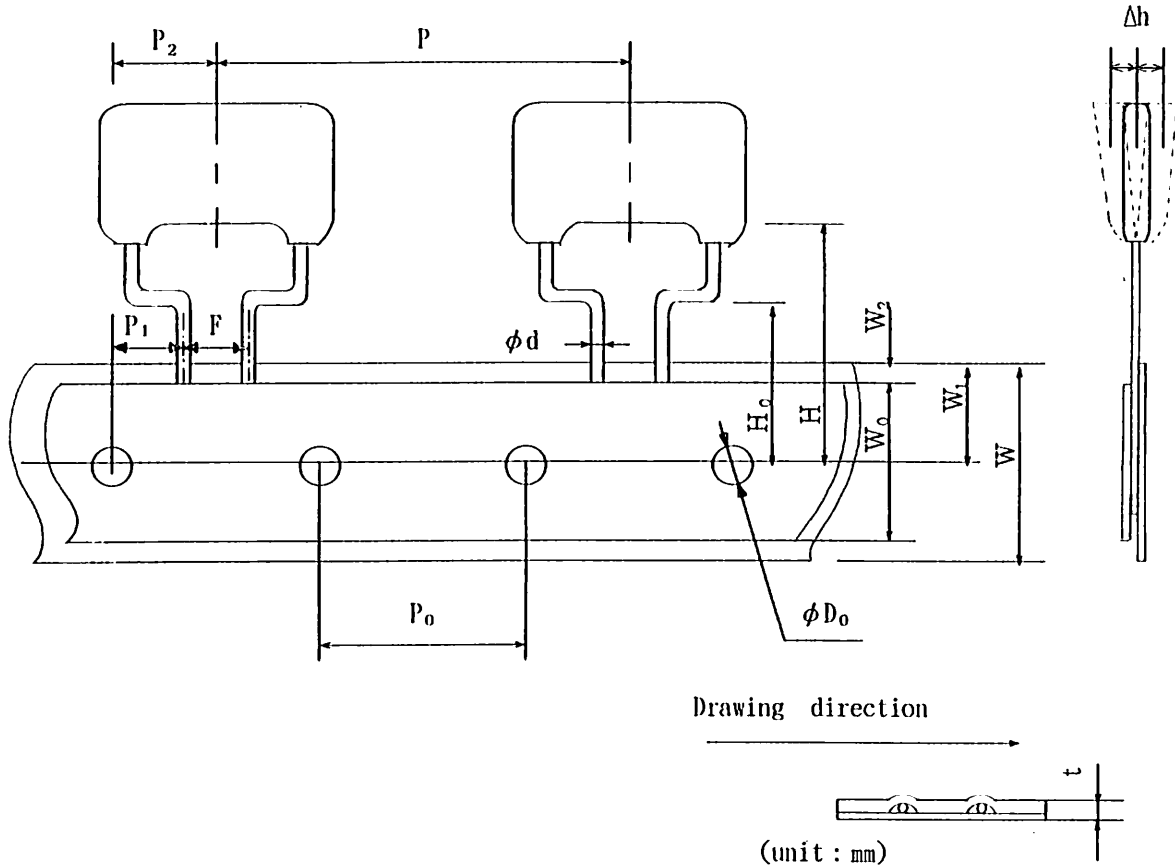

P	P ₀	(1) P ₁	P ₂	φ d	(1) F	(2) Δ h	W	W ₀	W ₁	(3) W ₂	H	(1) H ₀	φ D ₀	t
25.4	12.7	3.85	6.35	0.6 or 0.8	5.0	0	18.0	≥5.0	9.0	3.0 Max	22.0 Max	16.0	4.0	0.7
±1.0	±0.3	±0.7	±1.3	±0.05	±0.8 ±0.2	±2.0	±1.0 ±0.5	—	±0.5	—	—	±0.5	±0.2	±0.2

- (1) To be measured under the clinch-position.
- (2) To be measured the top of component.
- (3) Hold-down tape is not to exceed over the carrire tape.

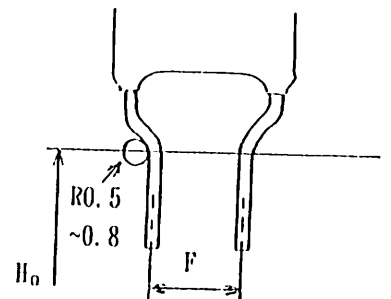

		SPEC No.
SPECIFICATION	METALLIZED POLYESTER FILM CAPACITORS	PSC305000

Type MMCV 184 ~ 334 250V. DC
 STYLE - 5 393 ~ 104 400V. DC
 393 ~ 104 450V. DC
 103 ~ 473 630V. DC

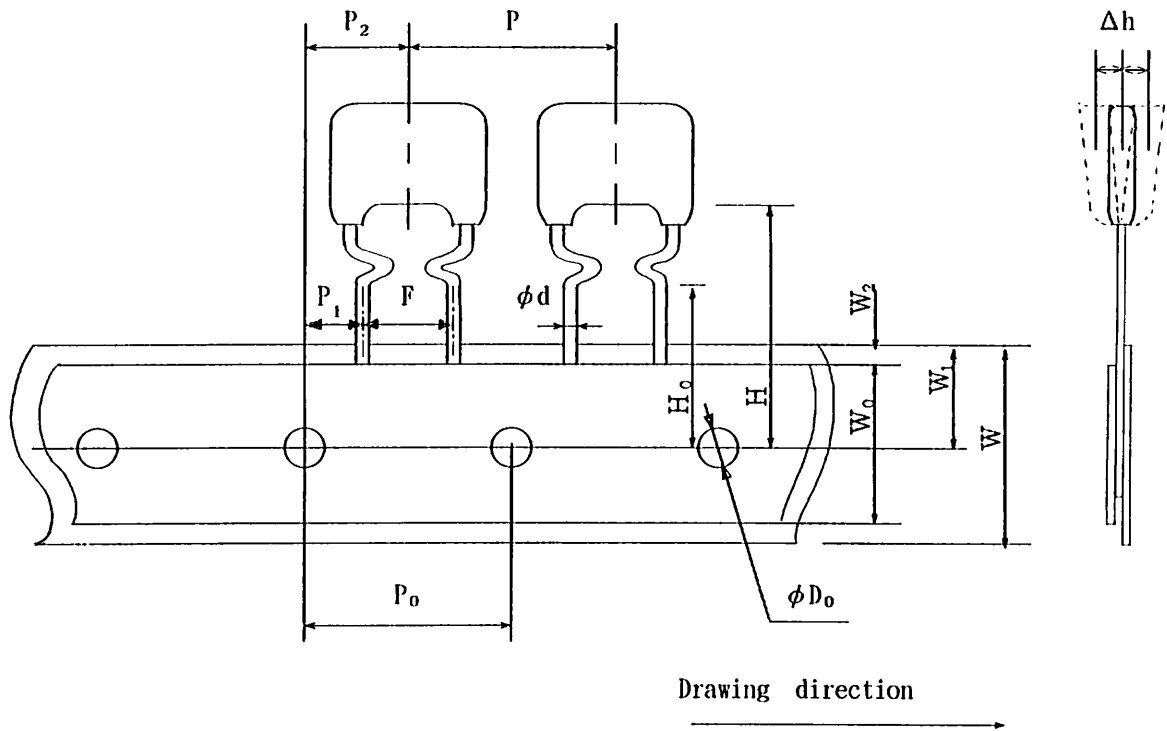

(unit : mm)

P	P ₀	(1) P ₁	P ₂	φ d	(1) F	(2) Δ h	W	W ₀	W ₁	(3) W ₂	H	(1) H ₀	φ D ₀	t
15.0	15.0	3.75	7.5	0.6 or 0.8	7.5	0	18.0	≥5.0	9.0	3.0 Max	22.0 Max	16.0	4.0	0.7
±1.0	±0.3	±0.7	±1.3	±0.05	±0.8 ±0.2	±2.0	±1.0 ±0.5	—	±0.5	—	—	±0.5	±0.2	±0.2

- (1) To be measured under the clinch-position.
- (2) To be measured the top of component.
- (3) Hold-down tape is not to exceed over the carrire tape.

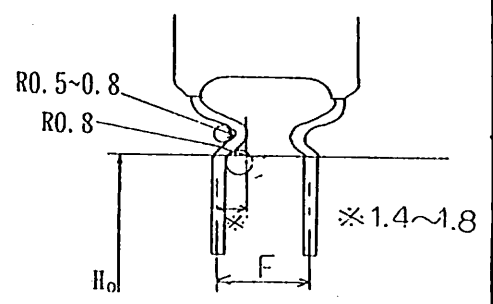

SPECIFICATION

METALLIZED POLYESTER FILM CAPACITORS

SPEC No.

PSC305000

Type MMCV	394 ~ 155	250V. DC
STYLE - 6	124 ~ 474	400V. DC
	124 ~ 474	450V. DC
	563 ~ 224	630V. DC

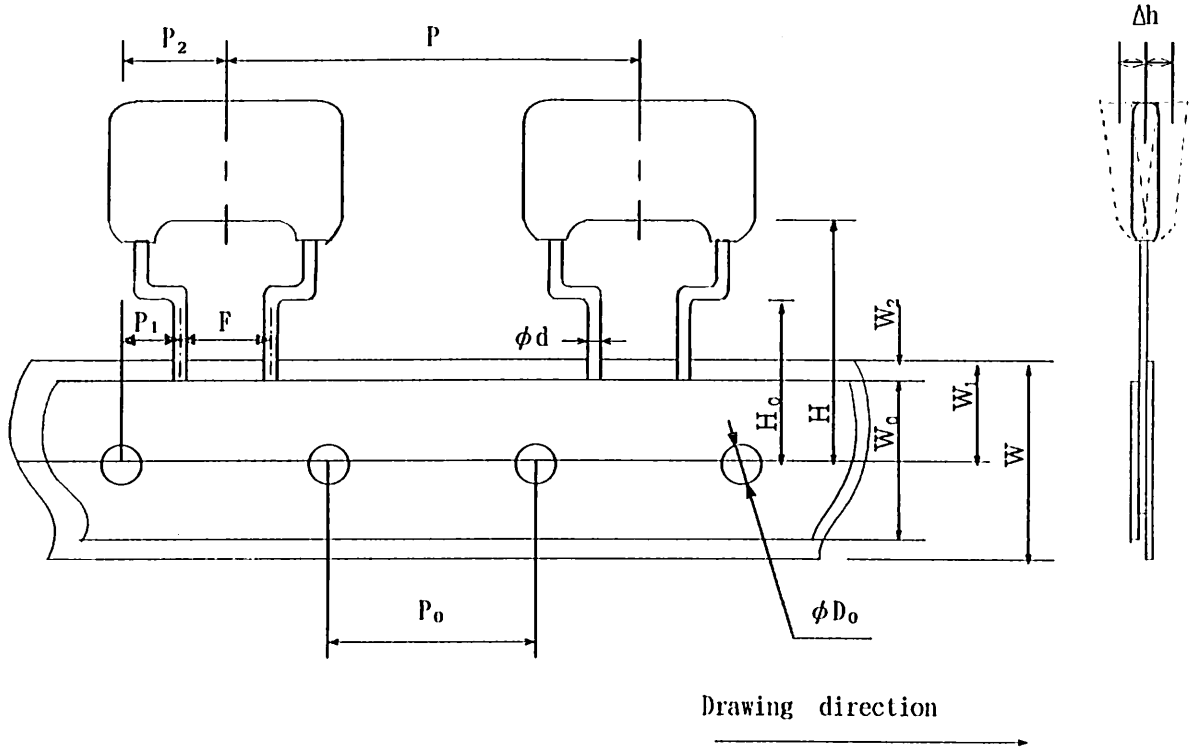

(unit : mm)

P	P ₀	(1) P ₁	P ₂	φ d	(1) F	(2) Δ h	W	W ₀	W ₁	(3) W ₂	H	(1) H ₀	φ D ₀	t
30.0	15.0	3.75	7.5	0.6 or 0.8	7.5	0	18.0	≥5.0	9.0	3.0 Max	22.0 Max	16.0	4.0	0.7
±1.0	±0.3	±0.7	±1.3	±0.05	±0.8 ±0.2	±2.0	±1.0 ±0.5	—	±0.5	—	—	±0.5	±0.2	±0.2

- (1) To be measured under the clinch-position.
- (2) To be measured the top of component.
- (3) Hold-down tape is not to exceed over the carrier tape.

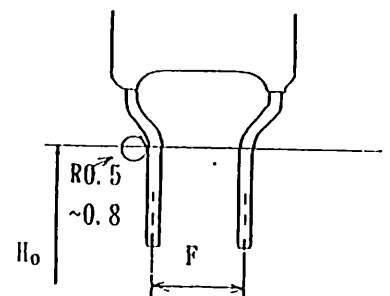

SPECIFICATION

METALLIZED POLYESTER FILM CAPACITORS

SPEC No

P S C 3 0 5 0 0 0

Packing quantity

MNCV-250V.DC

Capacitance (μ F)	Standard quantity (pcs)				
	STYLE-1	STYLE-2	STYLE-3	STYLE-5	STYLE-6
0.0010	1.000				
0.0012	"				
0.0015	"				
0.0018	"				
0.0022	"				
0.0027	"				
0.0033	"				
0.0039	"				
0.0047	"				
0.0056	"				
0.0068	"				
0.0082	"				
0.010	"				
0.012	"				
0.015	"				
0.018	"				
0.022	"				
0.027	"				
0.033	"				
0.039	"				
0.047	"				
0.056	"				
0.068	"				
0.082	"				
0.10	"				
0.12	"				
0.15	"				
0.18		1.000		1.000	
0.22		"		"	
0.27		"		"	
0.33		500		500	
0.39			500		500
0.47			"		"
0.56			"		"
0.68			"		"
0.82			"		400
0.90			"		"
1.0			400		"
1.2			"		"
1.5					300

SPECIFICATION

METALLIZED POLYESTER FILM CAPACITORS

SPEC No.

P S C 3 0 5 0 0 0

Packing quantity

MNCV-400V. DC

Capacitance (μ F)	Standard quantity (pcs)				
	STYLE-1	STYLE-2	STYLE-3	STYLE-5	STYLE-6
0.0010	1,000				
0.0012	"				
0.0015	"				
0.0018	"				
0.0022	"				
0.0027	"				
0.0033	"				
0.0039	"				
0.0047	"				
0.0056	"				
0.0068	"				
0.0082	"				
0.010	"				
0.012	"				
0.015	"				
0.018	"				
0.022	"				
0.027	"				
0.033	"				
0.039		1,000		1,000	
0.047		"		"	
0.056		"		"	
0.068		"		"	
0.082		"		"	
0.10		"		"	
0.12			500		500
0.15			"		"
0.18			"		"
0.22			"		400
0.27			"		"
0.33			400		300
0.39			"		"
0.47			"		"

SPECIFICATION

METALLIZED POLYESTER FILM CAPACITORS

SPEC No

P S C 3 0 5 0 0 0

Packing quantity

MNCV-450V. DC

Capacitance (μ F)	Standard quantity (pcs)				
	STYLE-1	STYLE-2	STYLE-3	STYLE-5	STYLE-6
0.0010	1.000				
0.0012	"				
0.0015	"				
0.0018	"				
0.0022	"				
0.0027	"				
0.0033	"				
0.0039	"				
0.0047	"				
0.0056	"				
0.0068	"				
0.0082	"				
0.010	"				
0.012	"				
0.015	"				
0.018	"				
0.022	"				
0.027	"				
0.033	"				
0.039		1.000		1.000	
0.047		"		"	
0.056		"		"	
0.068		"		"	
0.082		"		"	
0.10		"		"	
0.12			500		500
0.15			"		"
0.18			"		"
0.22			"		400
0.27			"		"
0.33			400		300
0.39			"		"
0.47			"		"

SPECIFICATION

METALLIZED POLYESTER FILM CAPACITORS

SPEC No

P S C 3 0 5 0 0 0

Packing quantity

MNCV-630V. DC

Capacitance (μ F)	Standard quantity (pcs)				
	STYLE-1	STYLE-2	STYLE-3	STYLE-5	STYLE-6
0.0010	1,000				
0.0012	"				
0.0015	"				
0.0018	"				
0.0022	"				
0.0027	"				
0.0033	"				
0.0039	"				
0.0047	"				
0.0056	"				
0.0068	"				
0.0082	"				
0.010		1,000		1,000	
0.012		"		"	
0.015		"		"	
0.018		"		"	
0.022		"		"	
0.027		"		"	
0.033		"		"	
0.039		"		"	
0.047		500		500	
0.056			500		500
0.068			"		"
0.082			"		400
0.10			"		"
0.12			"		"
0.15			400		300
0.18			"		"
0.22			"		"



Cautions about safety In use of Capacitors

(MMC type)

仕様番号

HWC305000

版

02

シート

1 / 2

When using a capacitor, please use one within the range of the specified values in the specification after checking the environments of using and mounting.

If used beyond the range specified in the specification or the attached cautions, it may lead to short circuit, open, smoking and firing.

Be sure to inquire of us as to the items which are not specified in the specification or are unclear to you.

Also, in case of using capacitors for such equipment or apparatus as may possibly affect human lives like life-support systems, aircraft and automotive control system, etc., please never fail to inquire of us as to further details.

1. Operating temperature and humidity

- (1) In actual use, make sure that the operating temperature is within the range specified in the specification.
- (2) Even if the operating temperature is within the specified range, sudden change in the operating temperature may lead to cracks on the enclosure and result in deterioration of the insulation resistance or the increase in tangent of loss angle by absorbing moisture through cracks on the enclosure.
Please take good care of the operating temperature.
- (3) Please avoid using a capacitor for a long time in succession in high humidity which may lead to the condensation as much as possible.
Even if there are no cracks or damage on an enclosure, deterioration of the insulation resistance or the increase in tangent of loss angle and so on may be caused by absorbing moisture.
Therefore, please be careful when using a capacitor.

2. When using a capacitor in a circuit except a d.c. one

- (1) When using a capacitor in a circuit except a d.c. one, a capacitor shall be used below the permissible current to frequency.
When used beyond the specified values, the capacitor surface temperature may rise due to the occurrence of corona charge or self heat generation of a capacitor and it may result in a short life, the destruction of the dielectric or the lowering of the insulation resistance.
At worst smoking or firing may be led.
- (2) Especially when used in a charge-and-discharge circuit, sudden charge and discharge may cause large surge current because of sudden change in voltage, which may lead to inferior contact between the internal evaporation electrode and the external takeout electrode or the increase in contact resistance and result in open.
Also, in case that a flow of surge current is frequent, the rms current may increase and it may result in smoking or firing due to heating by capacitor's self temperature rise.
- (3) When an a.c. voltage is applied to a capacitor or charge and discharge current flows in a capacitor, mechanical vibrations may occur in the dielectric film due to the coulomb force and the hum may be produced.
Though the hum doesn't spoil electrical characteristics of a capacitor, please confirm that there are no problems in use.
Also, in case that the hum becomes into question, please consult us.

3. Soldering

Soldering at high temperature and for hours may cause deterioration or characteristics or breakdown of a capacitor.

Be sure to solder a capacitor within the range specified in the specification when soldering. In case of soldering beyond the range recommended by us, please inquire of us as to the details in advance.

- (1) When dipping again in order to correct, dipping must be applied after the temperature of a capacitor comes down to a room temperature and within twice.
- (2) Avoid any work that puts the stress on lead wires of a capacitor such as correction of the position right after soldering.
- (3) When soldering with a soldering iron, please see to it lest a soldering iron should touch the body of a capacitor directly.

	<h1>Cautions about safety In use of Capacitors</h1>	登録番号 HWC305000	
	(MMC type)	版 02	シート 2/2

4. Mounting

- (1) When inserting a termination of a lead wire into the printed circuit board, the stress put on a lead wire shall be within the following range.
 - ① Bending of lead wire
When bending a lead wire vertically and then restoring straight, bending of a lead wire in the same place shall be less than two cycles. (One cycle -- bending at 90° and restoring straight)
 - ② Twisting of lead wire
Twisting of a lead wire should be carried out within a turn (a 360° turn) in total.
 - ③ Pulling of lead wire
The load in pulling of a lead wire shall be less than 20N.
In case that the above stress is combined together, the value in application should be set less than half of each value.
- (2) When mounting a capacitor by force owing to the difference of the space between lead wires of a capacitor from the space between the holes on the printed circuit board, be careful.
It may cause breakage of a lead wire or cracks on coating resin.
- (3) When mounting a capacitor of large size or a capacitor on the equipment affected by vibrations, fix the body of a capacitor with fixing utensils or with resin and so on which has no effect on a capacitor.
However, resin used for fixing shall be a flame retardant and minimum.
- (4) Mount a capacitor lest it should touch other parts.
Especially in case of touching a part with self heat generation, a capacitor may deteriorate due to heat and short circuit may be easily caused owing to lowering of dielectric strength or deterioration of the insulation resistance, etc..

5. Cleaning

- (1) When using the solvents for cleaning, use alcohol derivative cleaning solvents (isopropyl alcohol etc).
- (2) Since a small amount of ingredient contained in flux may lead to corrosion of terminations of a capacitor or chemical change of a capacitor element, be sure to clean a printed circuit board right after soldering.
- (3) The temperature for drying after cleaning shall be less than the maximum operating temperature.
- (4) When cleaning with solvents but alcohol derivatives, please inquire of us in advance.

6. Storing and waste

- (1) Store under the conditions not exceeding -10 °C ~ +40 °C , 75%RH in the room and avoid storing in the place filled with a sudden change in the temperature, the direct sunlight or corrosive gases (hydrogen sulfide, sulfurous acid, chlorine and ammonia, etc.).
- (2) A long-term storage may cause deterioration of characteristics of a capacitor owing to absorbing moisture little by little.
Therefore, be sure to use after checking its characteristics and solderability if stored for more than a year.
- (3) As capacitors are classified into industrial waste, please ask experts to dispose of them.

7. The others

Please refer to "Guideline of notabilia for fixed plastic film capacitors for use in electronic equipment" published by Electronic Industries Association of Japan (EIAJ RCR-2350) unless specified in the specification.