

# PRODUCT SPECIFICATION

新弘智

SPEC. NO: T-0602-141E

DATE: Mar.14,2019

CUSTOMER'S PRODUCT NAME:

EMTEK PRODUCT NAME:

**CMF4532F-SERIES-Tms**

THIS SPECIFICATION IS:

- FULLY ACCEPTED  
 DENIED  
 ACCEPTED UNDER THE FOLLOWING CONDITIONS



SIGNATURE: \_\_\_\_\_ DATE: \_\_\_\_\_

NAME(PRINT): \_\_\_\_\_

TITLE: \_\_\_\_\_

 **EMTEK CO., LTD.**

FACTORY:  
39,Chingao Rd.,(305)Hsinpu,  
Hsinchu Hsien,Taiwan,R.O.C  
TEL: 03-5894-433  
FAX: 03-5894-523

本文件內容全部或部份,未經兆欣科技股份有限公司同意不得以任何形式複製或其他用途  
All rights reserved.This document or parts thereof,may  
not be reproduced by any means or used in any manner  
witout written permission of EMTEK CO.,LTD.

# PRODUCT SPECIFICATION

SPEC. NO.

T-0602-141E



## 1. Scope

This specification applies ferrite Chip common mode filters CMF4532F-Series-Tms to be delivered to user.

## 2. Product Identification

CMF 4532 F - 600 - 2P - Tms

(1) (2) (3) (4) (5) (6)

- (1) Product name
- (2) Shapes and dimensions
- (3) Shielding Type
- (4) Impedance 【 at 100MHz 】  
600:60Ω
- (5) Number of Line  
2P:2-Line
- (6) For Customer Design

## 3. Shapes and Dimensions [Dimensions in mm]

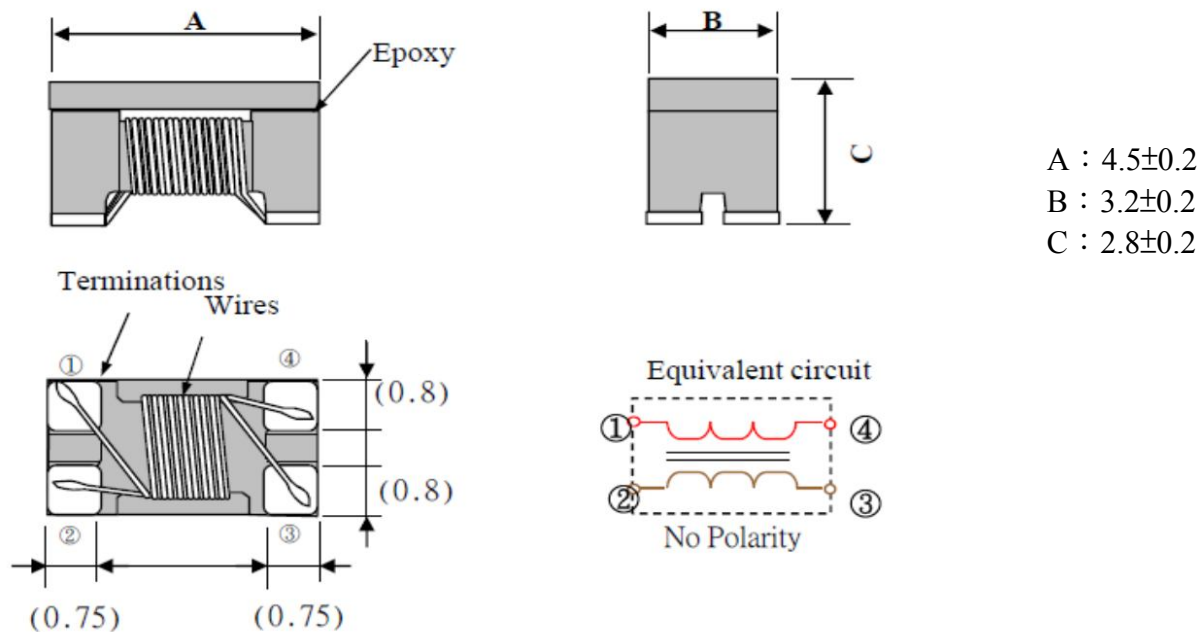

Drawn by	Checked by	Approved by
Cindy Dec. 1. 2016	Henry Dec. 1. 2016	Su Dec 1. 2016

# PRODUCT SPECIFICATION

SPEC. NO.

T-0602-141E



## 4. Electrical Characteristics

### 4-1 Electrical Spec.

Our Product Part Number	Common-Mode Impedance Z( $\Omega$ ) at 100MHz	Common-Mode Inductance uH at 100KHz	DC Resistance Rdc( $\Omega$ ) Max.	Rated Current Idc(A) Max.	Rated Voltage Vdc(V)	Withstanding Voltage Vdc(V)	Insulation Resistance (M $\Omega$ )Min.
CMF4532F-600-2P-Tms	60 $\pm$ 25%		0.05	2.0	50	125	10
CMF4532F-900-2P-Tms	90 $\pm$ 25%		0.05	2.0	50	125	10
CMF4532F-161-2P-Tms	160 $\pm$ 25%		0.08	2.0	50	125	10
CMF4532F-231-2P-Tms	230 $\pm$ 25%		0.10	1.8	50	125	10
CMF4532F-421-2P-Tms	420 $\pm$ 25%		0.10	1.6	50	125	10
CMF4532F-601-2P-Tms	600 $\pm$ 25%	2.0 $\pm$ 50%	0.07	2.8	50	125	10

Rated Current Idc : DC current (A) that will cause an approximate  $\Delta T$  of 40°C

### 4-2 Characteristics (Reference)

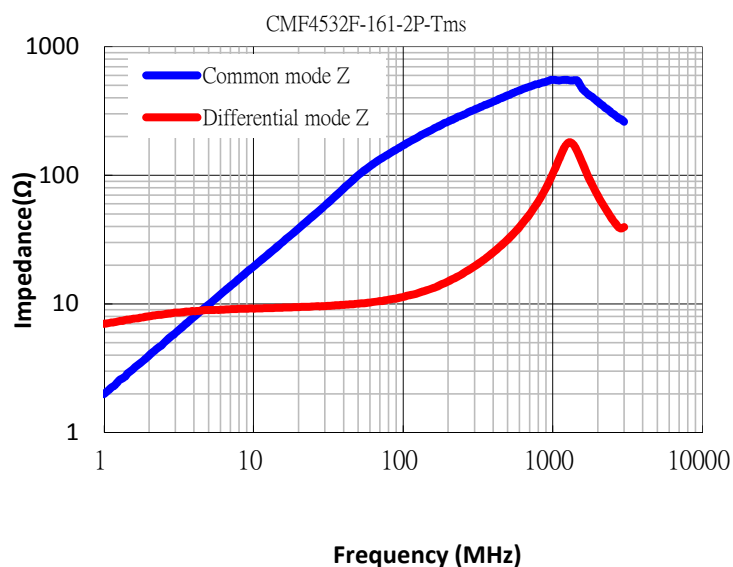
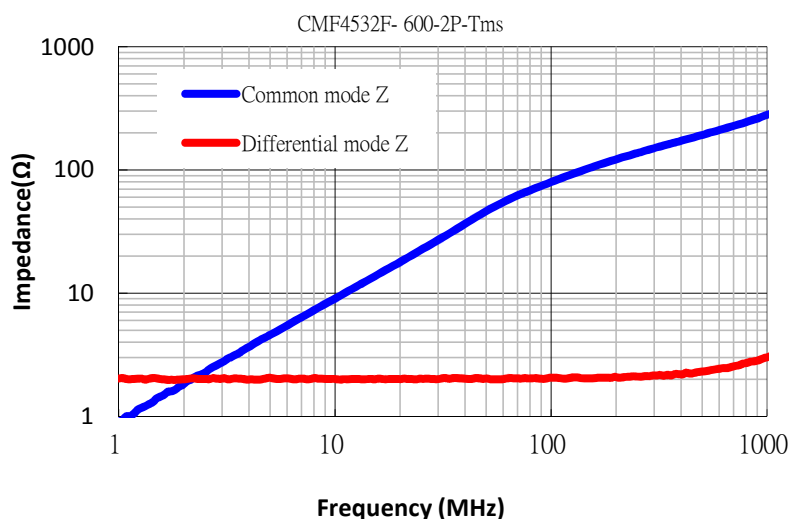

# PRODUCT SPECIFICATION

SPEC. NO.

T-0602-141E



## 4-2 Characteristics (Reference)

CMF4532F-421-2P-Tms

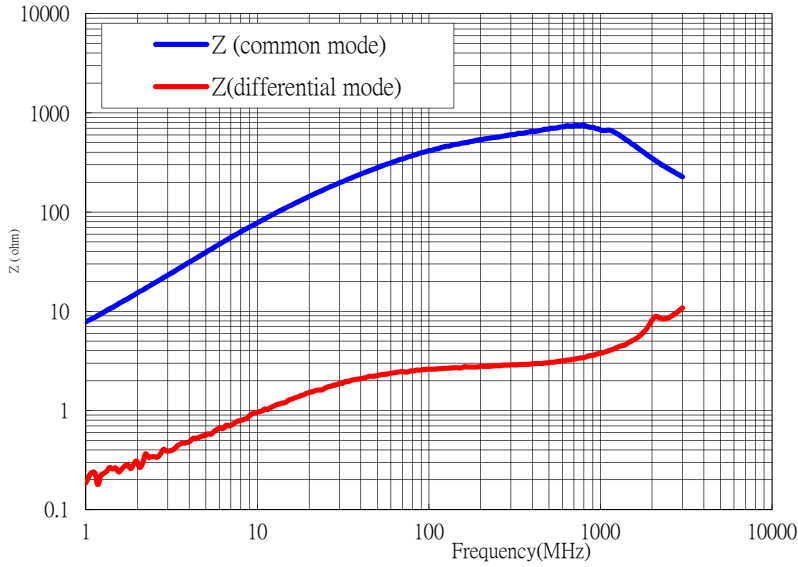

CMF4532F-601-2P-Tms

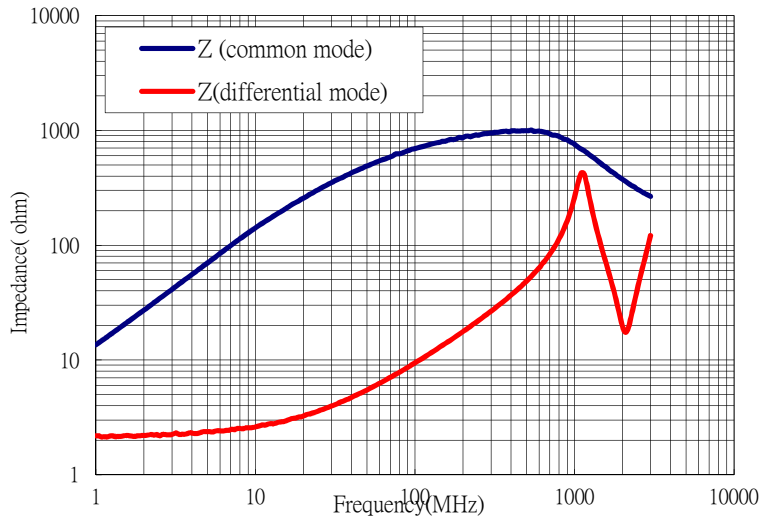

# PRODUCT SPECIFICATION

SPEC. NO.

T-0602-141E



## 4-3 Test Equipment

### 4-3-1 Impedance

Measured by using Agilent E4991A RF Impedance Analyzer.

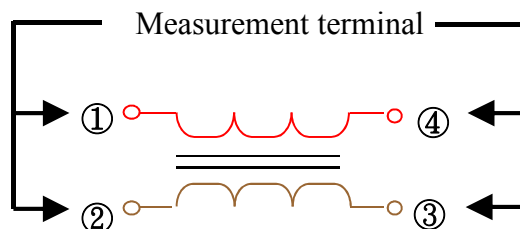

### 4-3-2 DC Resistance

Measured by using Chroma 16502 mill ohm meter.

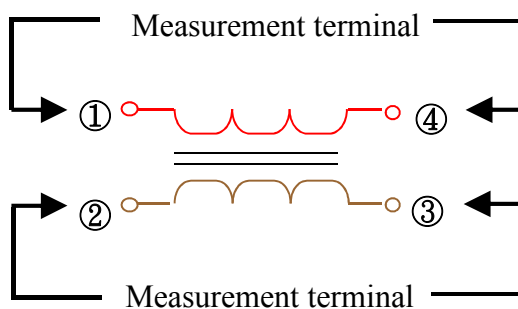

### 4-3-3 Insulation Resistance

Measured by using Chroma 19073

Measurement voltage : 50v, Measurement time: 60 sec.

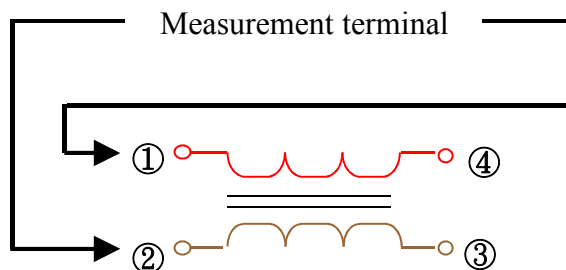

# PRODUCT SPECIFICATION

SPEC. NO.

T-0602-141E

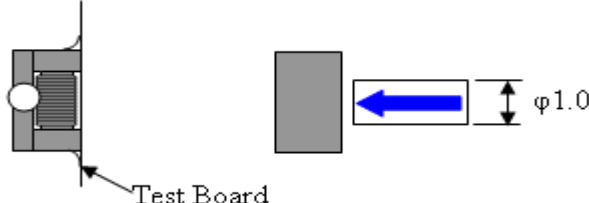
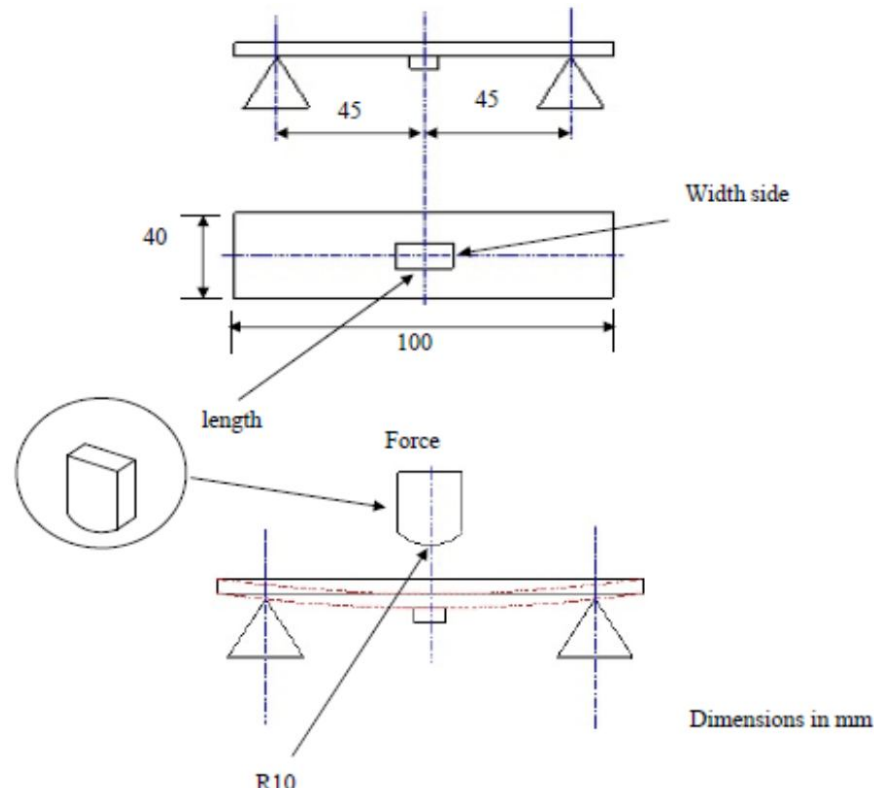

## 5. Reliability Test

Operating temperature : -40 to +125°C		Storage temp and humidity : -40 to 85°C, 70%RH max.
Item	Specifications	Test conditions
Solder-ability	It can be connected on the Recommendation soldering condition.	Apply cream solder to the test circuit board . It is mounted on the recommendation soldering condition.
Terminal strength	The terminal electrode and the ferrite must not be dam 160±25%	Solder a chip to test substrate, and then laterally apply a load 1.8Kg in the arrow direction. 
Strength on pc board bending	The terminal electrode and the ferrite must not be damaged.	Soldering a chip to a test substrate , bend the substrate by 2mm and then return.  <p>Dimensions in mm</p> <p>Test board : Glass base epoxy multiplayer board pc board pattern. PC board pattern : Recommended PC board pattern.</p>

# PRODUCT SPECIFICATION

SPEC. NO.

T-0602-141E

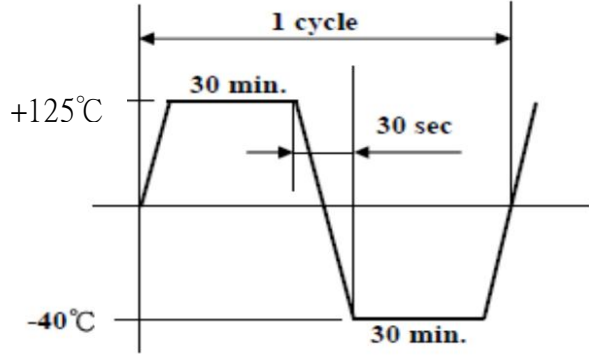

Item	Specifications	Test conditions
High temperature resistance	Appearance : Ferrite shall not be damaged. Impedance: Within $\pm 20\%$ of the initial value. insulation resistance: $>10(M\Omega)$ DC resistance : standard value	Temperature : $+125\pm 2^{\circ}C$ Applied voltage : Rated voltage Applied current : Rated current Testing time : $500\pm 12$ hours Measurement : After placing for 24 hours min.
Humidity resistance	inside.	Temperature : $+85\pm 2^{\circ}C$ Humidity : 90 to 95%RH Applied current : Rated current Applied voltage : Rated voltage Testing time : $500\pm 12$ hours Measurement : After placing for 24 hours min.
Thermal cycle		Temperature : $-40^{\circ}C, +125^{\circ}C$ kept stabilized for 30 minutes each. Cycle : 100 cycle Measurement : After placing for 24 hours min.  
Low temperature resistance		Temperature : $-40\pm 2^{\circ}C$ Testing time : $500\pm 12$ hours Measurement : After placing for 24 hours min.
Vibration	Appearance : Ferrite shall not be damaged.	Frequency : 10 to 50 Hz Amplitude : 1.52 mm Dimension and times : X ,Y and Z directions for 2 hours each.

# PRODUCT SPECIFICATION

SPEC. NO.

T-0602-141E



## 6. Packaging

The packaging must be done not to receive any damage during transporting and storing

### 6-1 Tape dimensions

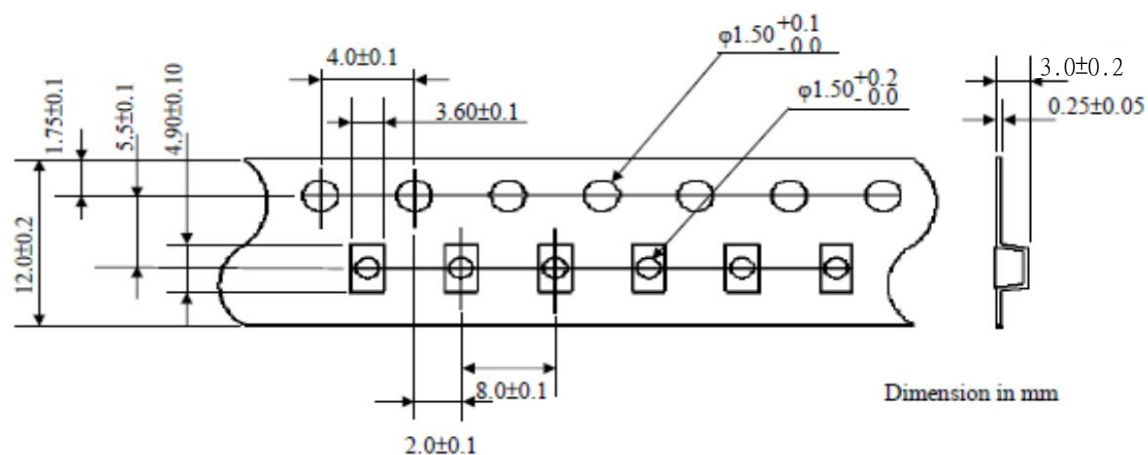

### 6-2 Reel dimensions

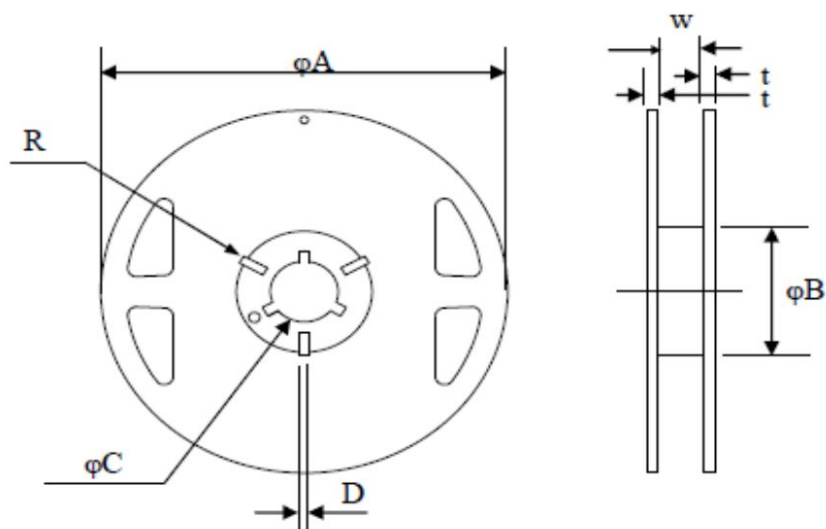

(Dimensions in mm)

Symbol	T
φA	180+0,-3
φB	60+1, -0
φC	13±0.2
D	2.2±0.5
W	12.0±0.3
t	1.2
R	1

### 6-3 Tapping figure

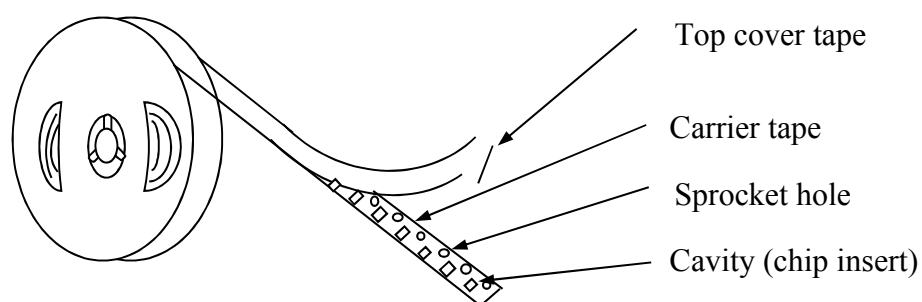



# PRODUCT SPECIFICATION

SPEC. NO.

T-0602-141E



## 6-4 Packaging Form

There shall not continuation more than two vacancies of the product.

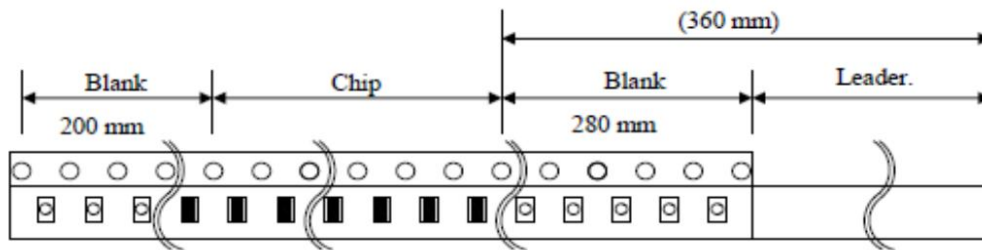

Material of carrier tape : Polystyrene

Material of cover tape : Polyester

## 6-5 Cover Tape Peel Strength

The force for tearing off cover tape is 0.05~0.69(N) in the arrow direction at the following conditions:

Temperature : 5 ~ 35°C

Humidity : 45 ~ 85%

Atmospheric pressure : 860 ~ 1060 hpa

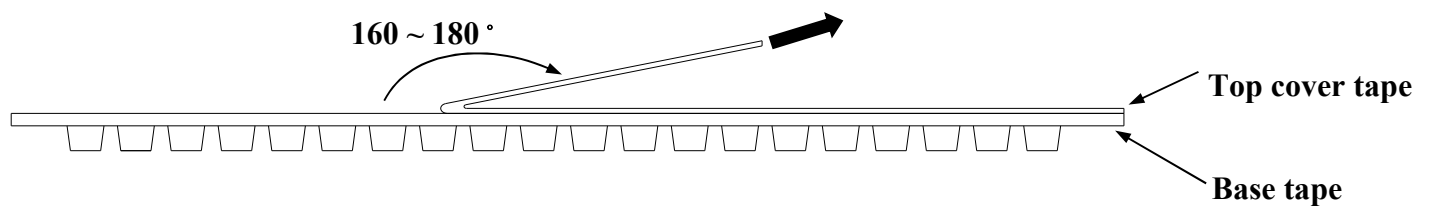

## 6-6 Packing Quantity

φ180 mm reel T type : 500 pcs./reel

# PRODUCT SPECIFICATION

SPEC. NO.

T-0602-141E



## 7. Recommended Soldering Conditions (Please use this product by reflow soldering)

### 7-1 Recommended Footprint

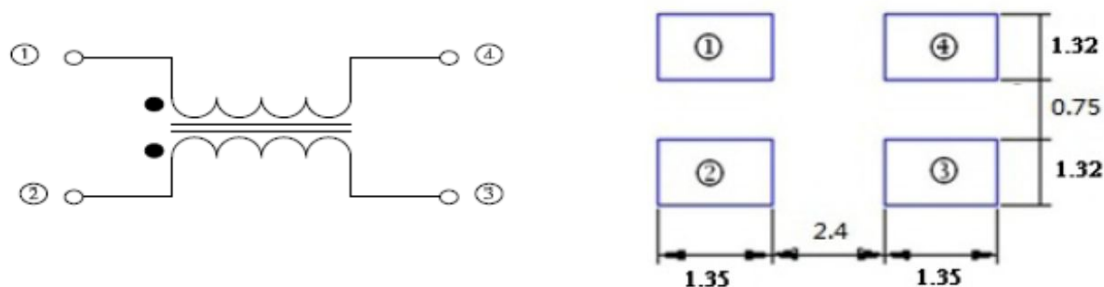

### 7-2 Recommended Reflow Pattern

Reflow: until two times

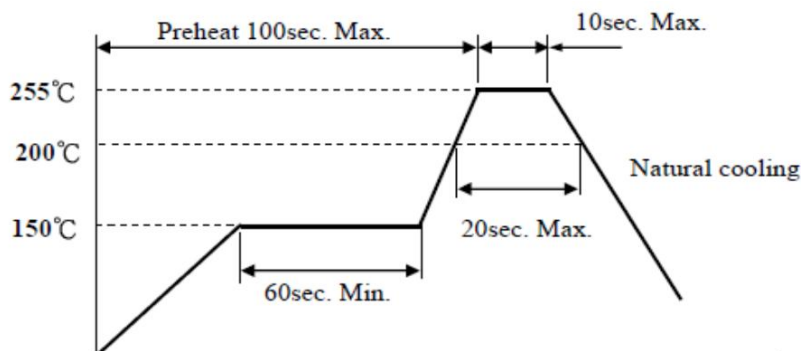

### 7-3 Iron Soldering

Use a solder iron of less than 30W when soldering, do not allow the soldering iron tip directly touch the ferrite body outside fo terminal electrode.

2 seconds max. at 280°C.

## 8. Attention in Case of Using

In case of using product, please avoid following matters:

- Splashing water or salt water
- Dew condenses
- Toxic gas (Hydrogen sulfide, Sulfurous acid, Chlorine, Ammonia)
- Vibrations or shocks which exceed the specified condition

Please be careful for the stress to this product by board flexure or something after the mounting.

\*Recommended wire wound inductors should be used within 6 months from the time of delivery.