

P-Channel Enhancement Mode Power Mosfet

BL2305

FEATURES

- Super High Dense Cell Design for Extremely Low $R_{DS(ON)}$
- Reliable and Rugged
- Electrostatic Sensitive Devices.
- MSL1

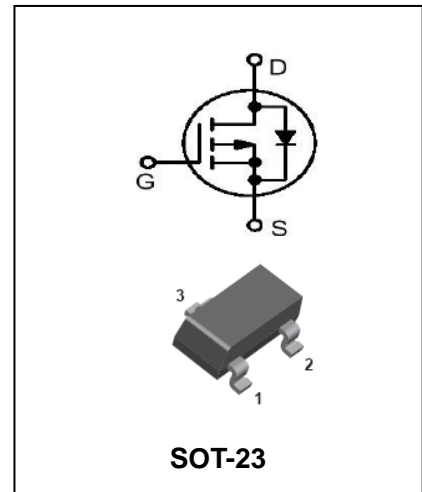

APPLICATIONS

- Power Management in Notebook.
- Portable Equipment.
- Battery Powered System.

ORDERING INFORMATION

Type No.	Marking	Package Code
BL2305□	2305	SOT-23

□: none is for Lead Free package;

“G” is for Halogen Free package.

MAXIMUM RATING @ $T_a=25^\circ\text{C}$ unless otherwise specified

Symbol	Parameter	Value	Units
V_{DSS}	Drain-Source voltage	-12	V
V_{GSS}	Gate -Source voltage	± 8	V
I_D	Maximum Drain current $T_A=25^\circ\text{C}$ $T_A=70^\circ\text{C}$	-4.2 -3.4	A
I_{DM}	Pulsed Drain current	-10	A
P_D	Power Dissipation	1.37	W
$R_{\theta JA}$	Thermal resistance, Junction-to-Ambient	90	$^\circ\text{C}/\text{W}$
T_J, T_{stg}	Operating Junction and Storage Temperature Range	-55~+150	$^\circ\text{C}$

P-Channel Enhancement Mode Power Mosfet

BL2305

ELECTRICAL CHARACTERISTICS @ Ta=25°C unless otherwise specified

Parameter	Symbol	Test conditions	MIN	TYP	MAX	UNIT
Drain-Source Breakdown Voltage	$V_{(BR)DSS}$	$V_{GS}=0V, I_D=-250\mu A$	-12	-	-	V
Gate Threshold Voltage	$V_{GS(th)}$	$V_{DS}=V_{GS}, I_D=-250\mu A$	-0.5	-	-	V
Forward Transconductance	gfs	$V_{DS}=-5V, I_D=-2.8A$	-	9	-	S
Gate-body Leakage	I_{GSS}	$V_{DS}=0V, V_{GS}=8V$	-	-	100	nA
		$V_{DS}=0V, V_{GS}=-8V$	-	-	-100	nA
Zero Gate Voltage Drain Current	I_{DSS}	$V_{DS}=-12V, V_{GS}=0V$	-	-	-1	μA
Drain-Source on-resistance	$R_{DS(ON)}$	$V_{GS}=-10V, I_D=-4.5A$	-	-	53	m Ω
		$V_{GS}=-4.5V, I_D=-4.2A$	-	-	65	
		$V_{GS}=-2.5V, I_D=-2.0A$	-	-	100	
		$V_{GS}=-1.8V, I_D=-1.0A$	-	-	250	
Diode forward voltage	V_{SD}	$V_{GS}=0V, I_S=-1.2A$	-	-	-1.2	V
Total Gate Charge	Qg	$V_{DS}=-16V, V_{GS}=-4.5V, I_D=-4.2A$	-	10.6	-	nC
Gate-Source Charge	Qgs		-	2.32	-	
Gate-Drain Charge	Qgd		-	3.68	-	
Input capacitance	C_{ISS}	$V_{DS}=-15V, V_{GS}=0V, f=1.0MHz$	-	740	-	pF
Output capacitance	C_{OSS}		-	167	-	
Reverse transfer capacitance	C_{RSS}		-	126	-	
Turn-On Delay Time	$t_{D(ON)}$	$V_{DS} = -15V, I_D = -4.2A, R_G = 6\Omega, V_{GS} = -10V, R_D = 3.6\Omega$	-	5.9	-	ns
Rise Time	t_R		-	3.6	-	
Turn-Off Delay Time	$t_{D(OFF)}$		-	32.4	-	
Fall Time	t_F		-	2.6	-	
Reverse Recovery Time	Trr	$I_S=-4.2A, V_{GS}=0$	-	27.7	-	ns
Reverse Recovery Charge	Qrr	$di/dt=100A/us$	-	22	-	nC

TYPICAL CHARACTERISTICS @ Ta=25°C unless otherwise specified

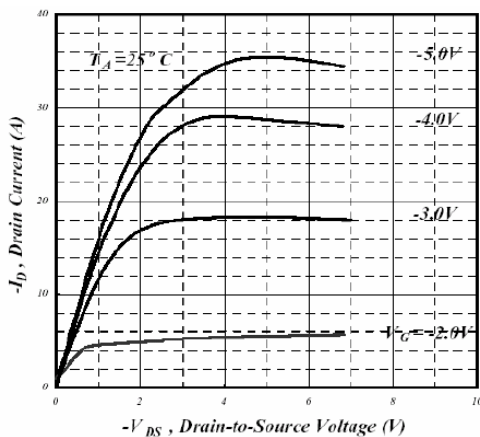

Fig 1. Typical Output Characteristics

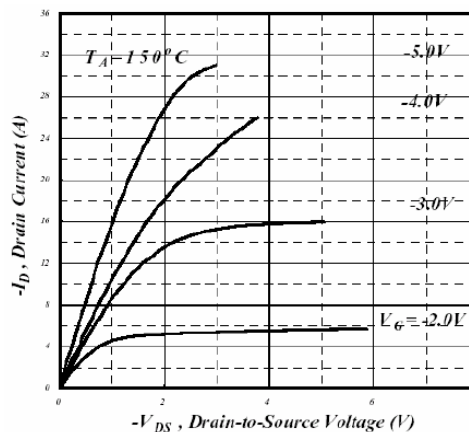

Fig 2. Typical Output Characteristics

P-Channel Enhancement Mode Power Mosfet

BL2305

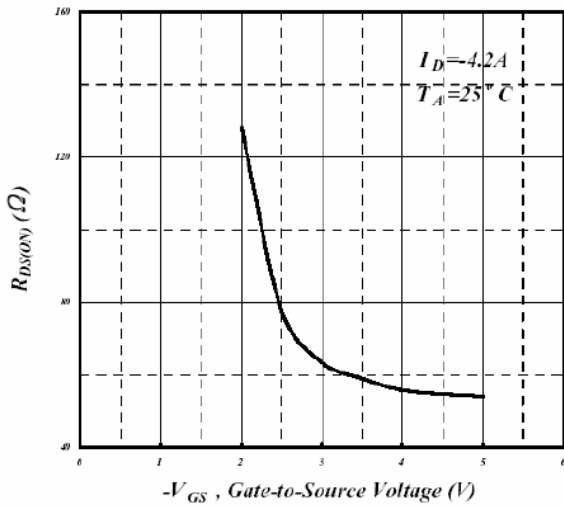

Fig 3. On-Resistance v.s. Gate Voltage

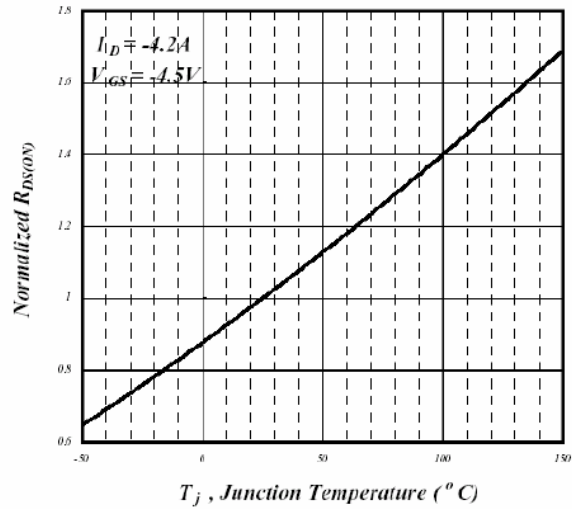

Fig 4. Normalized On-Resistance v.s. Junction Temperature

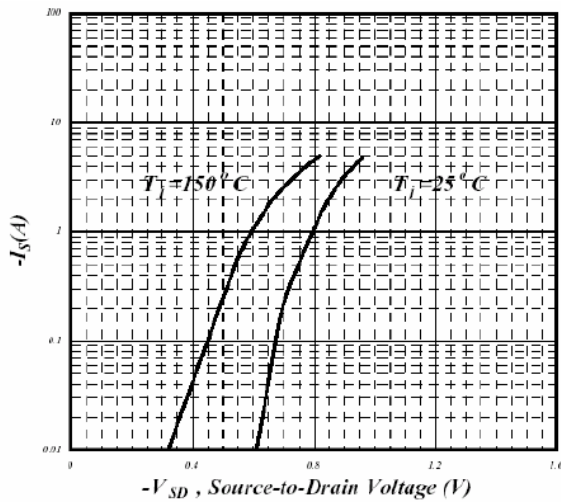

Fig 5. Forward Characteristic of Reverse Diode

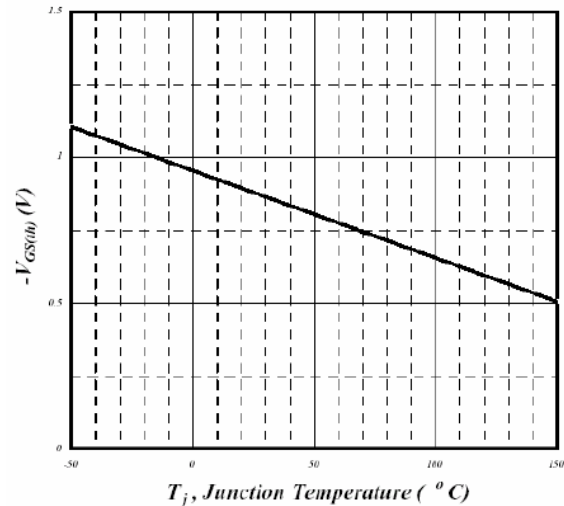

Fig 6. Gate Threshold Voltage v.s. Junction Temperature

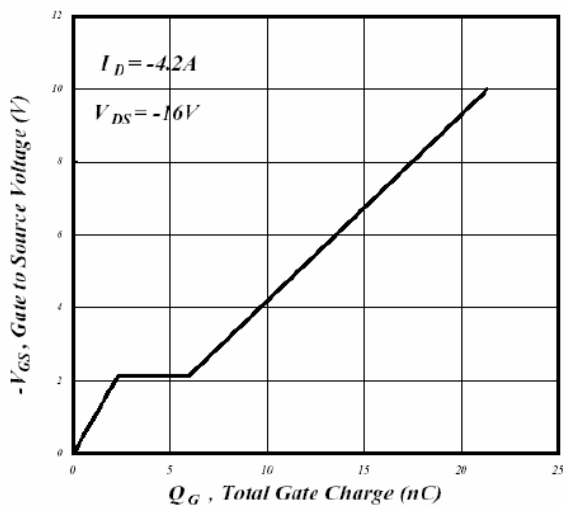

Fig 7. Gate Charge Characteristics

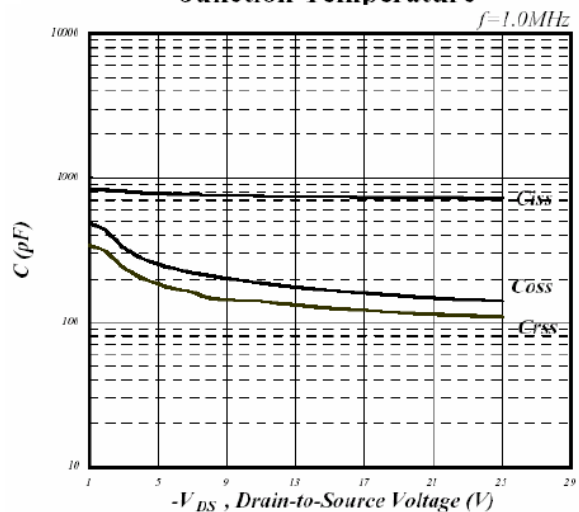

Fig 8. Typical Capacitance Characteristics

P-Channel Enhancement Mode Power Mosfet

BL2305

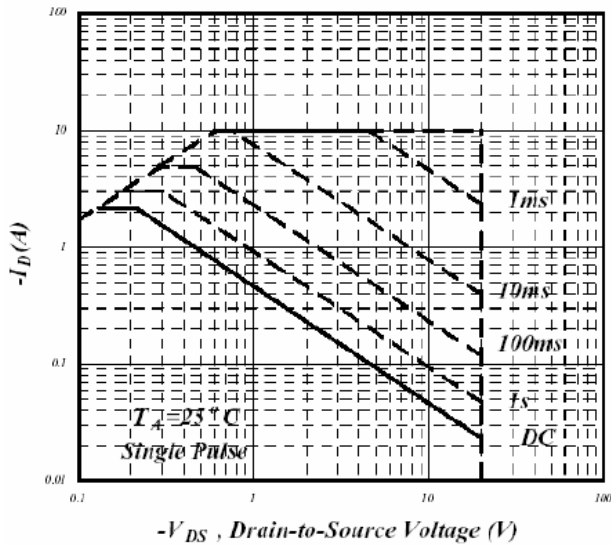

Fig 9. Maximum Safe Operating Area

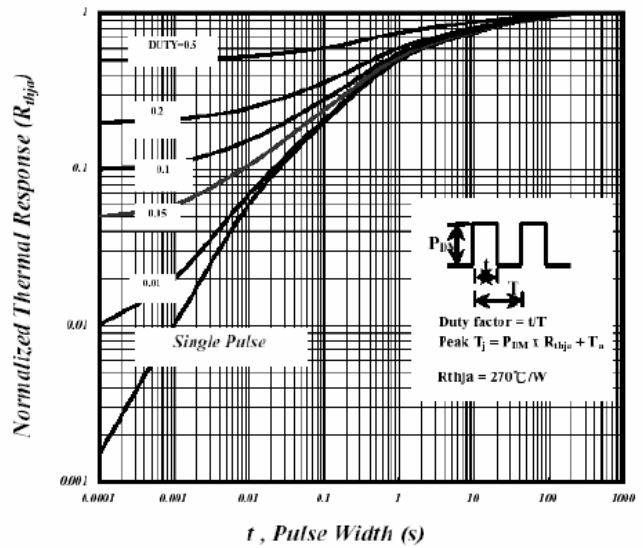

Fig 10. Effective Transient Thermal Impedance

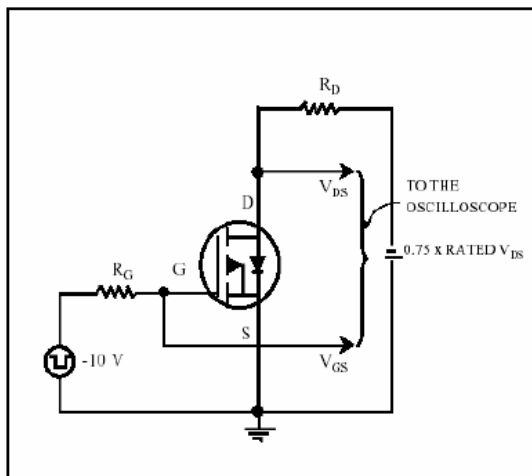

Fig 11. Switching Time Circuit

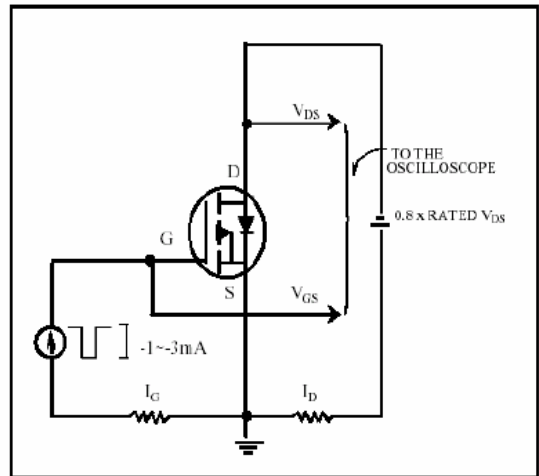

Fig 12. Gate Charge Circuit

P-Channel Enhancement Mode Power Mosfet

BL2305

PACKAGE OUTLINE

Plastic surface mounted package

SOT-23

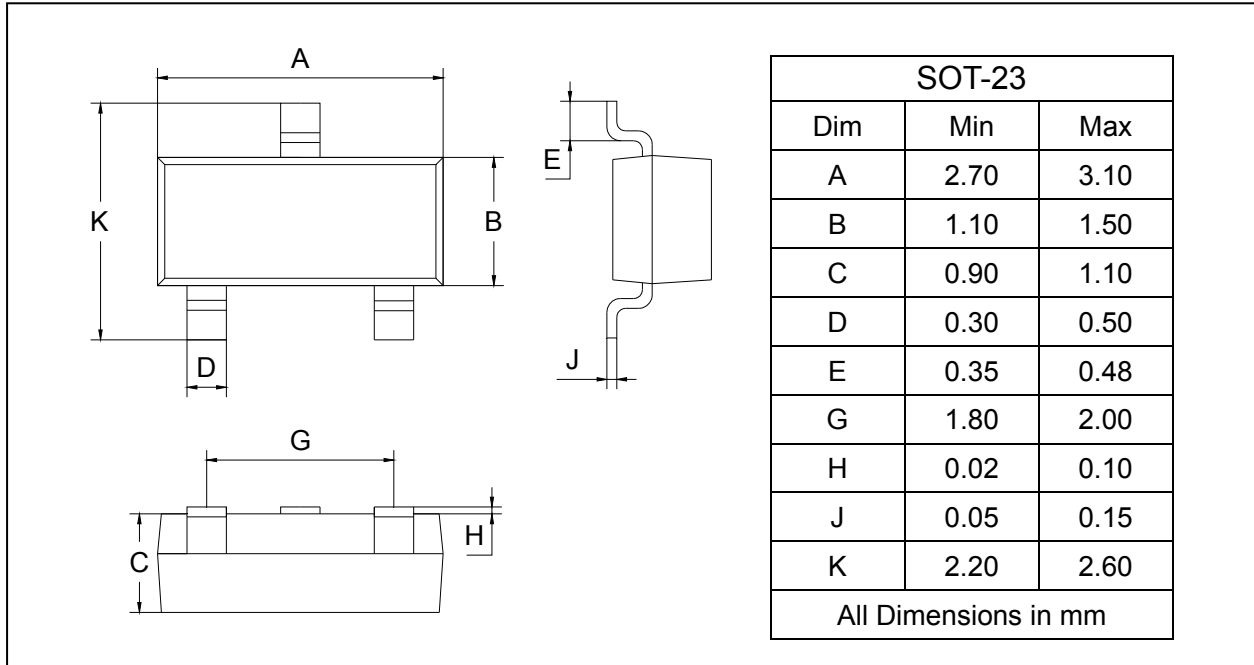

SOLDERING FOOTPRINT

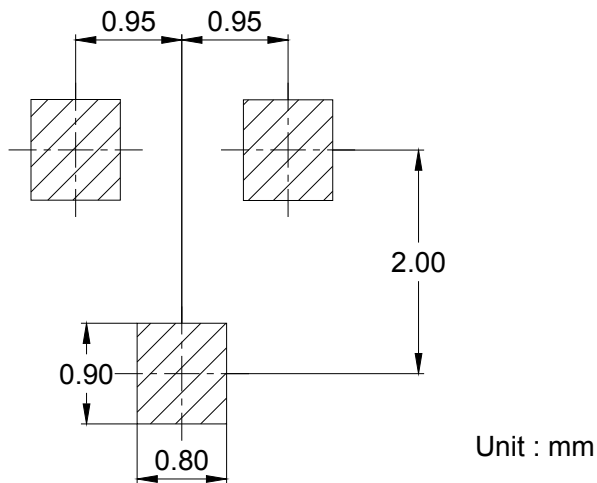

PACKAGE INFORMATION

Device	Package	Shipping
BL2305	SOT-23	3000/Tape&Reel