

**Performance Specification**

Model	V <sub>max</sub>	I <sub>max</sub>	I <sub>hold</sub>	I <sub>trip</sub>	P <sub>d</sub>	Maximum		Resistance	
						Time To Trip		R <sub>i min</sub>	R <sub>1max</sub>
			@25°C	@25°C	Typ.	Current	Time		
	(V dc)	(A)	(A)	(A)	(W)	(A)	(Sec)		
JK-mSMD 010SF	30.0	100	0.10	0.30	0.8	0.5	1.50	0.750	15.000
JK-mSMD 014SF	60.0	100	0.14	0.34	0.8	1.5	0.15	0.650	6.000
JK-mSMD 020SF	30.0	100	0.20	0.40	0.8	8.0	0.02	0.350	5.000
JK-mSMD 030SF	30.0	100	0.30	0.60	0.8	8.0	0.10	0.250	3.000
JK-mSMD 050SF	15.0	100	0.50	1.00	0.8	8.0	0.15	0.150	1.000
JK-mSMD 050SF/33V	33.0	100	0.50	1.00	0.8	8.0	0.15	0.150	1.000
JK-mSMD 050SF/60V	60.0	100	0.50	1.00	0.8	8.0	0.15	0.150	1.400
JK-mSMD 075SF	13.2	100	0.75	1.50	0.8	8.0	0.20	0.090	0.450
JK-mSMD 110SF	8.0	100	1.10	2.20	0.8	8.0	0.30	0.050	0.250
JK-mSMD 110SF/16V	16.0	100	1.10	2.20	0.8	8.0	0.30	0.050	0.250
JK-mSMD 125SF	16.0	100	1.25	2.50	0.8	8.0	0.40	0.050	0.140
JK-mSMD 150SF	8.0	100	1.50	3.00	0.8	8.0	0.50	0.040	0.160
JK-mSMD 150SF/16V	16.0	100	1.50	3.00	0.8	8.0	0.50	0.040	0.160
JK-mSMD 150SF/24V	24.0	100	1.50	3.00	0.8	8.0	0.50	0.040	0.160
JK-mSMD R160SF	8.0	100	1.60	2.80	0.8	8.0	1.00	0.030	0.130
JK-mSMD 200SF	8.0	100	2.00	4.00	0.8	8.0	2.00	0.020	0.100
JK-mSMD 260SF	8.0	100	2.60	5.00	0.8	8.0	2.50	0.015	0.050
JK-mSMD 300SF	8.0	100	3.00	5.00	0.8	8.0	4.00	0.012	0.040
JK-mSMD 350SF	6.0	100	3.50	6.00	2.0	10.0	4.00	0.008	0.030

V<sub>max</sub> = Maximum operating voltage device can withstand without damage at rated current (I<sub>max</sub>).

I<sub>max</sub> = Maximum fault current device can withstand without damage at rated voltage (V<sub>max</sub>).

I<sub>hold</sub> = Hold Current. Maximum current device will not trip in 25°C still air.

I<sub>trip</sub> = Trip Current. Minimum current at which the device will always trip in 25°C still air.

P<sub>d</sub> = Power dissipation when device is in the tripped state in 25°C still air environment at rated voltage.

R<sub>i min/max</sub> = Minimum/Maximum device resistance prior to tripping at 25°C.

R<sub>1max</sub> = Maximum device resistance is measured one hour post reflow.

CAUTION : Operation beyond the specified ratings may result in damage and possible arcing and flame.

**Environmental Specifications**

Test	Conditions	Resistance change
Passive aging	+85°C, 1000 hrs.	±5% typical
Humidity aging	+85°C, 85% R.H. , 168 hours	±5% typical
Thermal shock	+85°C to -40°C, 20 times	±33% typical
Resistance to solvent	MIL-STD-202, Method 215	No change
Vibration	MIL-STD-202, Method 201	No change
Ambient operating conditions : - 40 °C to +85 °C		
Maximum surface temperature of the device in the tripped state is 125 °C		

**Agency Approval and Environmental Compliance**

Agency	File Number	Regulation	Standard
UL	EN217453		2002/95/EC
TUV	pending		EN14582

**Thermal Derating Chart**

Recommended Hold Current(A) at Ambient Temperature(°C)

Model	Ambient Operation Temperature								
	-40°C	-20°C	0°C	25°C	40°C	50°C	60°C	70°C	85°C
SMD1812R010SF	0.16	0.14	0.12	0.10	0.08	0.07	0.06	0.05	0.03
SMD1812R014SF	0.23	0.19	0.17	0.14	0.12	0.10	0.09	0.08	0.06
SMD1812R020SF	0.29	0.26	0.23	0.20	0.17	0.15	0.14	0.12	0.10
SMD1812R030SF	0.44	0.39	0.35	0.30	0.26	0.23	0.21	0.18	0.15
SMD1812R050SF	0.59	0.57	0.55	0.50	0.45	0.43	0.35	0.30	0.23
SMD182R075SF	1.10	0.99	0.87	0.75	0.63	0.57	0.49	0.45	0.35
SMD1812R110SF	1.60	1.45	1.28	1.10	0.92	0.83	0.71	0.66	0.52
SMD1812R110SF16V	1.59	1.44	1.27	1.10	0.92	0.82	0.70	0.64	0.50
SMD1812R125SF	2.00	1.75	1.52	1.25	1.00	0.95	0.90	0.75	0.53
SMD1812R150SF	2.30	2.05	1.77	1.50	1.23	1.09	0.95	0.82	0.61
SMD1812R150SF16V	2.28	2.03	1.75	1.50	1.21	1.07	0.93	0.79	0.58
SMD1812R160SF	2.10	1.96	1.88	1.60	1.26	1.12	0.98	0.84	0.63
SMD1812R200SF	2.88	2.61	2.25	2.00	1.80	1.66	1.45	1.09	0.80
SMD1812R260SF	3.90	3.42	2.96	2.60	2.33	2.07	1.94	1.35	1.00
SMD1812R300SF	4.15	3.76	3.46	3.00	2.55	2.28	2.01	1.61	1.33
SMD1812R350SF	4.84	4.39	4.04	3.50	2.98	2.66	2.35	1.88	1.55

**Thermal Derating Curve**

**Average Time-Current Curve**

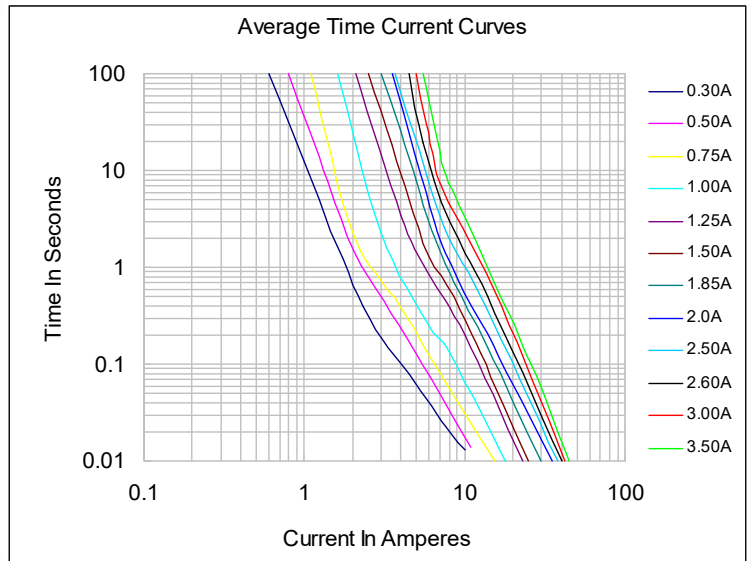
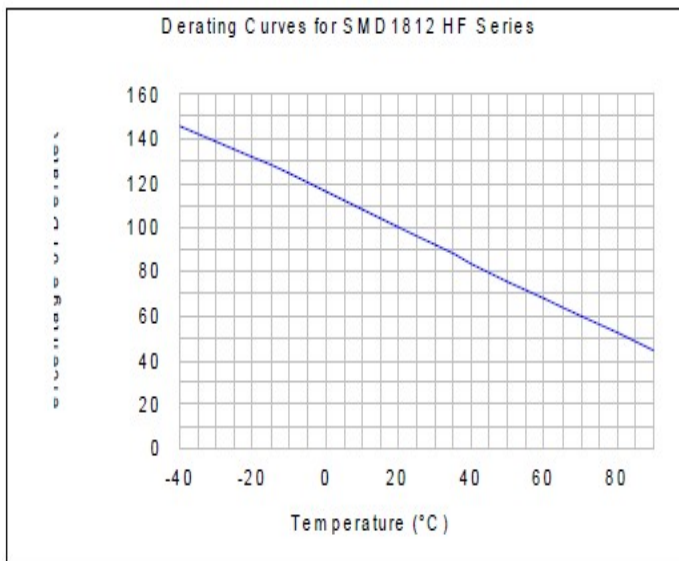

**Soldering Parameters**

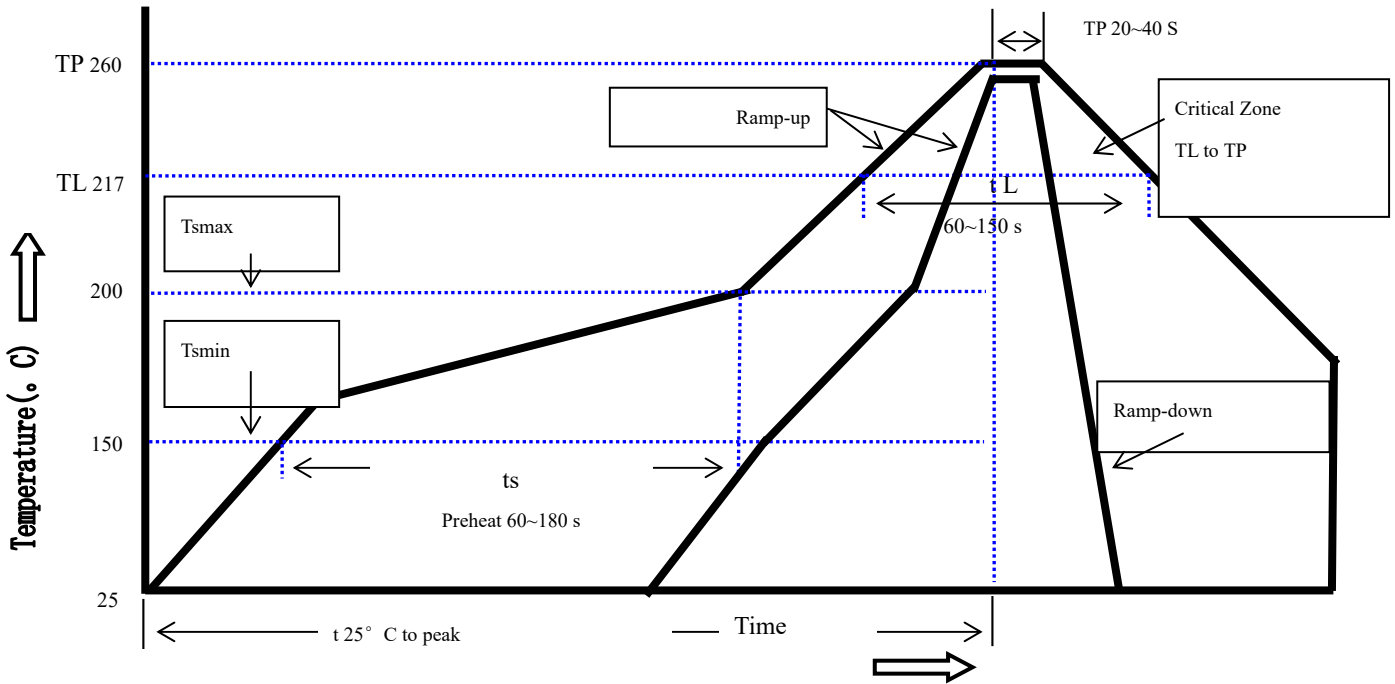

Profile Feature	Pb-Free Assembly
Average Ramp-Up Rate(Ts max to T p)	3°C/second max.
Preheat	
-Temperature Min(Ts min)	150°C
-Temperature Max(Ts max)	200°C
-Time(Ts min to Ts max)	60~180 seconds
Time maintained above:	
-Temperature(TL)	217°C
-Time(tL)	60~150 seconds
Peak Temperature(Tp)	260°C
Ramp-Down Rate	6°C/second max.
Time 25°C to Peak Temperature	8 minutes max
Storage Condition	0°C~35°C, ≤70%RH

Recommended reflow methods: IR, vapor phase oven, hot air oven, N2 environment for lead-free

Recommended maximum paste thickness is 0.25mm

Devices can be cleaned using standard industry methods and solvents.

Note 1: All temperature refer to topside of the package, measured on the package body surface.

Note 2: If reflow temperatures exceed the recommended profile, devices may not meet the performance requirements.

**Physical Dimensions(mm.)**

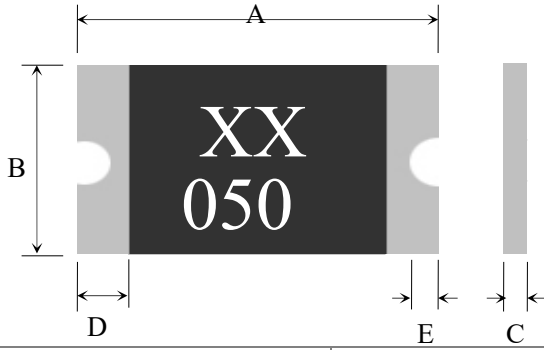

Model	A		B		C		D	E
	Min.	Max.	Min.	Max.	Min.	Max.	Min.	Min.
SMD1812R010SF	4.37	4.73	3.07	3.41	0.50	1.00	0.30	0.25
SMD1812R014SF	4.37	4.73	3.07	3.41	0.50	1.00	0.30	0.25
SMD1812R020SF	4.37	4.73	3.07	3.41	0.50	1.30	0.30	0.25
SMD1812R030SF	4.37	4.73	3.07	3.41	0.50	1.00	0.30	0.25
SMD1812R050SF	4.37	4.73	3.07	3.41	0.40	0.90	0.30	0.25
SMD1812R050SF33V	4.37	4.73	3.07	3.41	0.70	1.30	0.30	0.25
SMD1812R050SF60V	4.37	4.73	3.07	3.41	1.10	1.80	0.30	0.25
SMD182R075SF	4.37	4.73	3.07	3.41	0.40	0.90	0.30	0.25
SMD1812R110SF	4.37	4.73	3.07	3.41	0.40	0.90	0.30	0.25
SMD1812R110SF16V	4.37	4.73	3.07	3.41	0.60	1.30	0.30	0.25
SMD1812R125SF	4.37	4.73	3.07	3.41	0.60	1.30	0.30	0.25
SMD1812R150SF	4.37	4.73	3.07	3.41	0.40	1.20	0.30	0.25
SMD1812R150SF16V	4.37	4.73	3.07	3.41	0.40	1.20	0.30	0.25
SMD1812R160SF	4.37	4.73	3.07	3.41	0.40	1.20	0.30	0.25
SMD1812R200SF	4.37	4.73	3.07	3.41	0.50	1.30	0.30	0.25
SMD1812R260SF	4.37	4.73	3.07	3.41	0.50	1.50	0.30	0.25
SMD1812R300SF	4.37	4.73	3.07	3.41	0.50	1.50	0.30	0.25
SMD1812R350SF	4.37	4.73	3.07	3.41	0.50	1.50	0.30	0.25

**Termination Pad Characteristics**

Terminal pad materials: Tin-plated Nickel-Copper

Terminal pad solder ability: Meets EIA specification RS186-9E and ANSI/J-STD-002 Category 3.

**Recommended Pad Layout (mm.)**

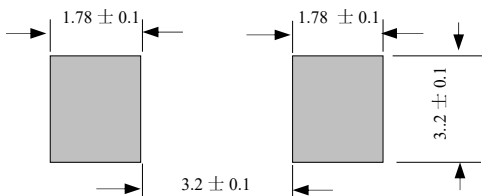

**Packaging Quantity**

Part Number	Quantity
SMD812 Series	1,500 pcs/reel

Tape & reel packaging per EIA481-1

**Tape And Reel Specifications (mm)**

**Governing**

Specifications	EIA 481-1
W	12 ± 0.3
P0	4.0 ± 0.10
P1	8.0 ± 0.10
P2	2.0 ± 0.05
A0	3.5 ± 0.10
B0	5.1 ± 0.10
B1max.	5.9
D0	1.50 + 0.1, -0
F	5.5 ± 0.05
E1	1.75 ± 0.10
E2min.	10.25
T	0.6
T1max.	0.1
K0	0.9 ± 0.1
Leader min.	390
Trailer min.	160
Reel Dimensions	
A max.	178
N min.	60
W1	12.4 ± 0.5
W2	18.4

EIA Tape Component Dimensions

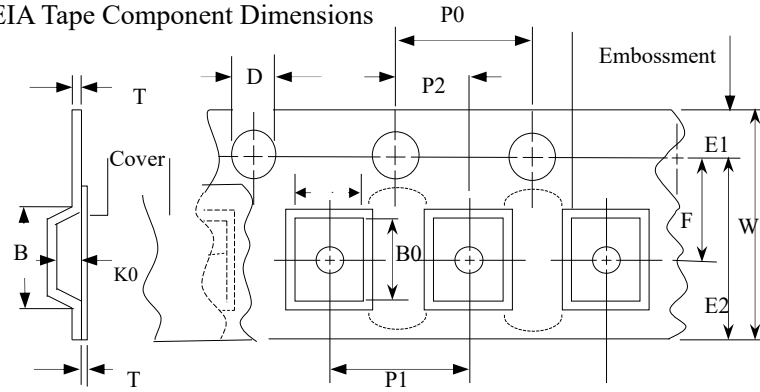

EIA Reel Dimensions

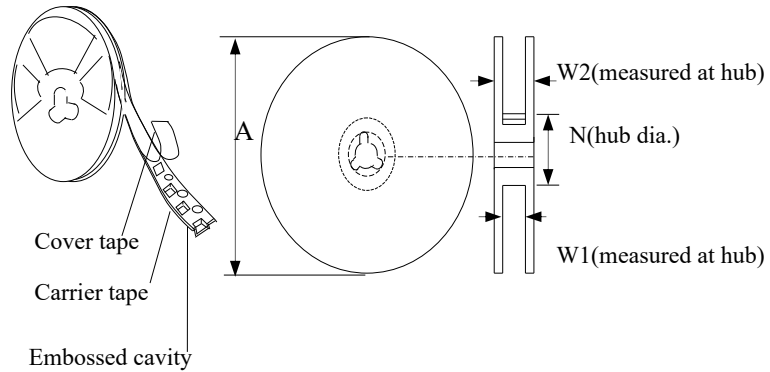

**Storage And Handling**

- Storage conditions: 35°C max, 70% R.H.
- Devices may not meet specified performance if storage conditions are exceeded.

**Part Number System**

JK - mSMD □□□ S F □□ V

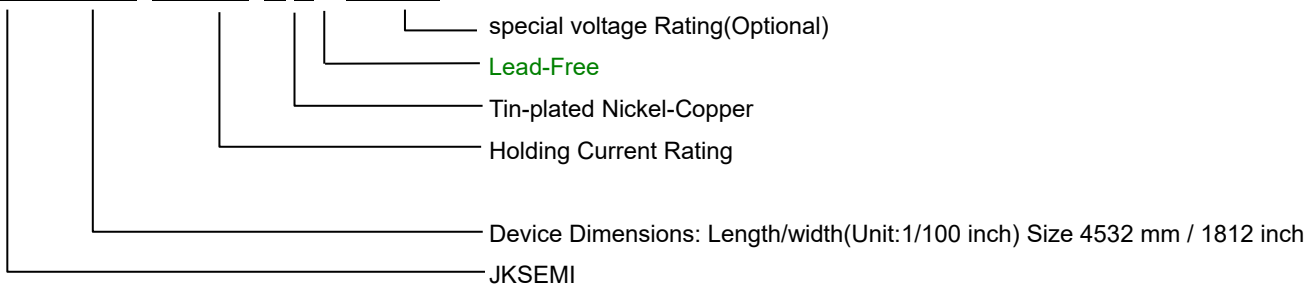

**Cross Reference**

Darong	Cross Reference				
	TYCO/Raychem	Littelfuse	Bourns / Multifuse®	Polytronics / EVERFUSE®	SEA-LAND
SMD1812R010SF	miniSMDC010F	1812L010	MF-MSMF010	SMD1812P010TF	mSMD010
SMD1812R014SF	-miniSMDC014F	1812L014	MF-MSMF014	SMD1812P014TF	mSMD014
SMD1812R020SF	miniSMDC020F	1812L020	MF-MSMF020	SMD1812P020TF	mSMD020
SMD1812R030SF	-	1812L030	MF-MSMF030	SMD1812P030TF	mSMD030
SMD1812R050SF	miniSMDC050F	1812L050	MF-MSMF050	SMD1812P050TF	mSMD050
SMD1812R050SF33V	miniSMDC050F	1812L050-30	-	SMD1812P050TF/30	mSMD050-33V
SMD1812R050SF60V	-	1812L050-60	-	-	mSMD050-60V
SMD182R075SF	miniSMDC750F	1812L075	MF-MSMF075	SMD1812P075TF	mSMD075
SMD1812R110SF	miniSMDC110F	1812L110	MF-MSMF110	SMD1812P110TF	mSMD110
SMD1812R110SF16V	miniSMDC110F/16	-	MF-MSMF110/16	SMD1812P110TF/16	mSMD110-16V
SMD1812R125SF	miniSMDC125F	1812L125	MF-MSMF125	SMD1812P125TF	mSMD125
SMD1812R150SF	miniSMDC150F	1812L150	MF-MSMF150	SMD1812P150TF	mSMD150
SMD1812R150SF16V	miniSMDC150F/12	1812L150-12	-	SMD1812P150TF/12	mSMD150-16V
SMD1812R160SF	miniSMDC160F	1812L160	MF-MSMF160	SMD1812P160TF	mSMD160
SMD1812R200SF	miniSMDC200F	1812L200	MF-MSMF200	SMD1812P200TFT	mSMD200
SMD1812R260SF	miniSMDC260F	1812L260	MF-MSMF260	SMD1812P260TFT	mSMD260
SMD1812R300SF	miniSMDC300F	1812L300	-	SMD1812P300TFT	mSMD300
SMD1812R350SF	-	-	-	-	mSMD350

“Raychem” is a registered trademark of Tyco Electronics.

“Littelfuse” is a registered trademark of Littelfuse

“Multifuse” is a registered trademark of bourns,Inc.

“EVERFUSE” is a registered trademark of Polytronics Technology Corp.

“SEA-LAND” is a registered trademark of Sea-Land electronic corp.

Website: <http://www.jksemi.com>

For additional information, please contact your local Sales Representative.

©Copyright 2016, jk semi



is a registered trademark of jk semi All rights are reserved