

产品规格书

| 批准 | 审核 | 校核 | 编制 |
|------------|------------|------------|------------|
| 申东春 | 纪春华 | 朴致均 | 郑羿 |
| 2018.03.02 | 2018.03.02 | 2018.03.02 | 2018.03.02 |

规格书更改履历:

| 序号 | 更改内容 | 履历号 | 更改时间 | 责任人 |
|----|------|-----|------------|-----|
| 1 | 新规制定 | 000 | 2018.03.02 | 郑羿 |
| | | | | |
| | | | | |
| | | | | |

Small Signal Fast Switching Diode

General Description

Dual general-purpose switching diodes, fabricated in planar technology, and packaged in small SOT-23 surface mounted device (SMD) packages.

Features and Benefits

Silicon epitaxial planar diode

High switching speed: $t_{rr} \leq 4\text{ns}$

Low forward drop voltage and low leakage current

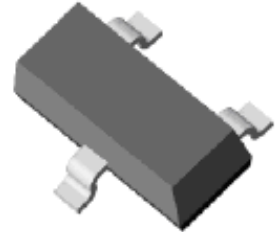

SOT-23

Applications

Ultra high speed switching application

Ordering Information

| Part Number | Marking Code | Package | Packaging |
|-------------|--------------|---------|-------------|
| KDS7000C | C5C □. | SOT-23 | Tape & Reel |

Marking Information

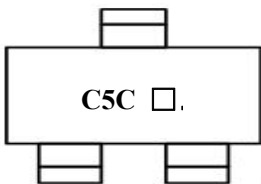

C5C= Specific Device Code

□ = Year & Week Code Marking

● = DaLian

Pinning Information

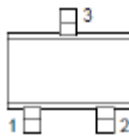
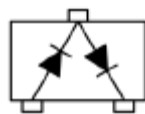
| Pin | Description | Simplified Outline | Graphic Symbol |
|-----|---------------------------------------|--|---|
| 1 | Anode (Diode 1) |  |  |
| 2 | Cathode (Diode 2) | | |
| 3 | Cathode (Diode 1), Anode (Diode 2) | | |

Absolute Maximum Ratings (T_{amb}=25°C, Unless otherwise specified)

| Characteristic | Symbol | Ratings | Unit |
|---|------------------|---------|------|
| Maximum repetitive peak reverse voltage | V _{RM} | 85 | V |
| Continuous reverse voltage | V _R | 80 | V |
| Maximum average forward rectified current | I _O | 100 | mA |
| Forward current (DC) | I _F | 100 | mA |
| Maximum repetitive peak forward current | I _{FM} | 300 | mA |
| Non-repetitive peak forward surge current(t=10ms) | I _{FSM} | 2 | A |
| Power dissipation ¹⁾ | P _D | 150 | mW |

1) Device mounted on FR-4 board with recommended pad layout.

Thermal Characteristics (T_{amb}=25°C, Unless otherwise specified)

| Characteristic | Symbol | Ratings | Unit |
|---|----------------------|---------|------|
| Thermal resistance, junction to ambient ¹⁾ | R _{th(j-a)} | 830 | °C/W |
| Operating junction temperature | T _j | 150 | °C |
| Storage temperature range | T _{stg} | -50~150 | °C |

1) Device mounted on FR-4 board with recommended pad layout.

Electrical Characteristics (T_{amb}=25°C, Unless otherwise specified)

| Characteristic | Symbol | Test Condition | Min. | Typ. | Max. | Unit. |
|---------------------------------------|-------------------|-------------------------------|------|------|------|-------|
| Forward voltage ²⁾ | V _{F(1)} | I _F =1mA | - | 0.6 | - | V |
| | V _{F(2)} | I _F =10mA | - | 0.7 | - | V |
| | V _{F(3)} | I _F =100mA | - | 0.9 | 1.2 | V |
| Reverse leakage current ³⁾ | I _R | V _R =80V | - | - | 0.5 | μA |
| Total capacitance | C _T | V _R =0V, f=1 MHz | - | 2.2 | 4.0 | pF |
| Reverse recovery time | t _{rr} | I _F =10mA (Fig. 5) | - | 1.6 | 4.0 | ns |

2) Pulse test: t_P≤380μs, Duty cycle≤2%

3) Pulse test: t_P≤5 ms, Duty cycle≤2%

Rating and Characteristic Curves

Fig. 1) Typical Forward Characteristics

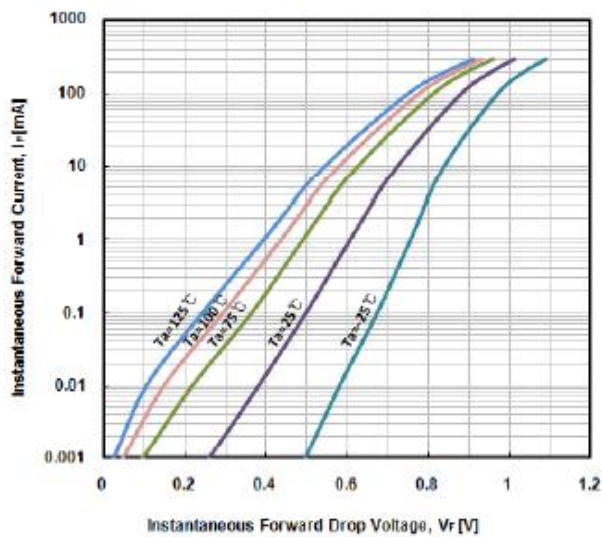

Fig. 2) Typical Reverse Characteristics

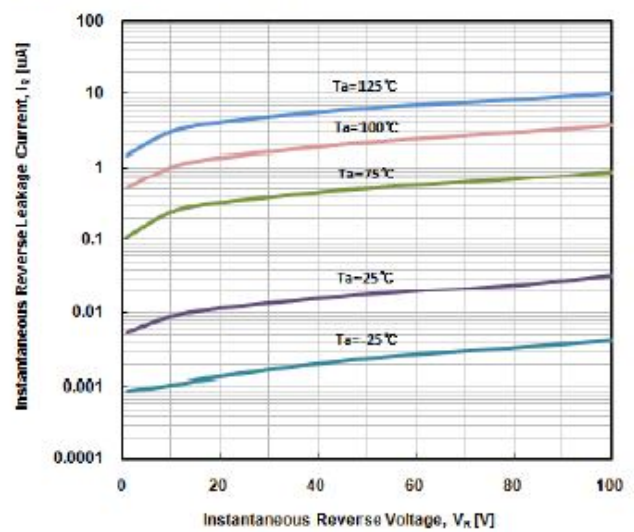

Fig. 3) Typical Total Capacitance Characteristics

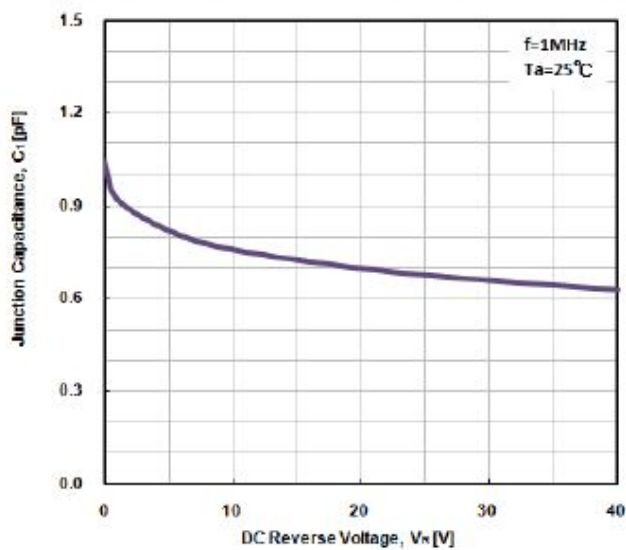

Fig. 4) Reverse Recovery Time vs. Forward Current

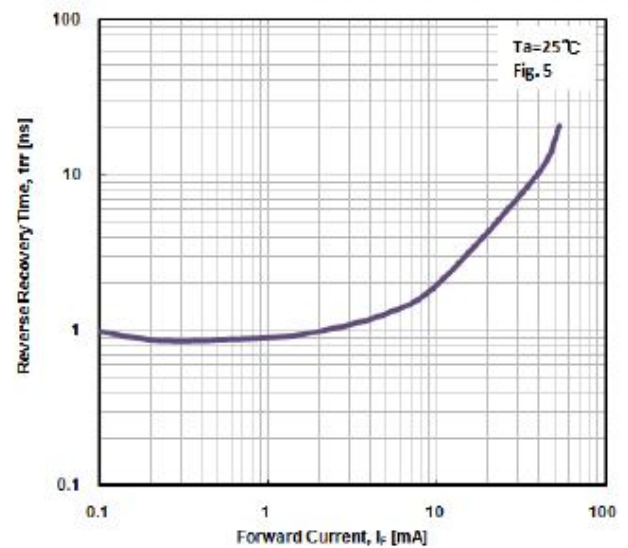
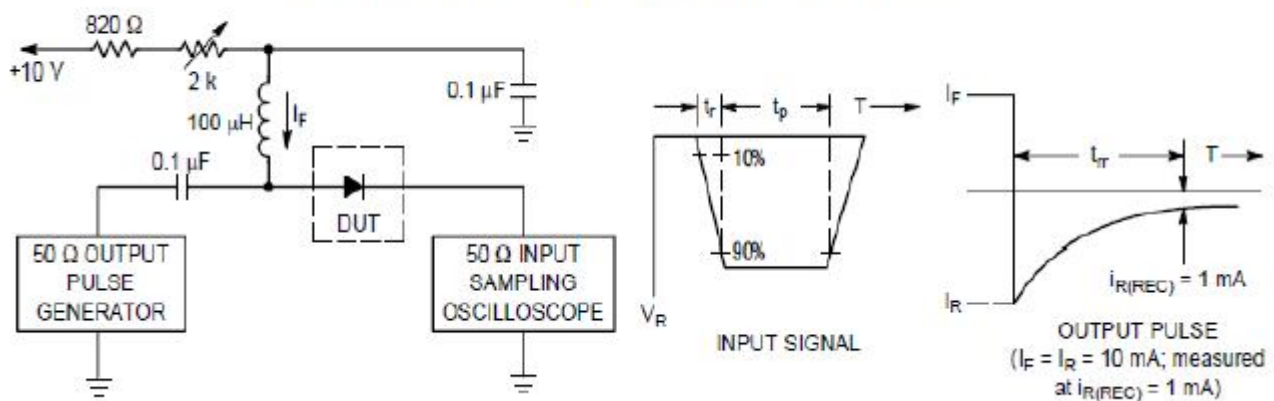
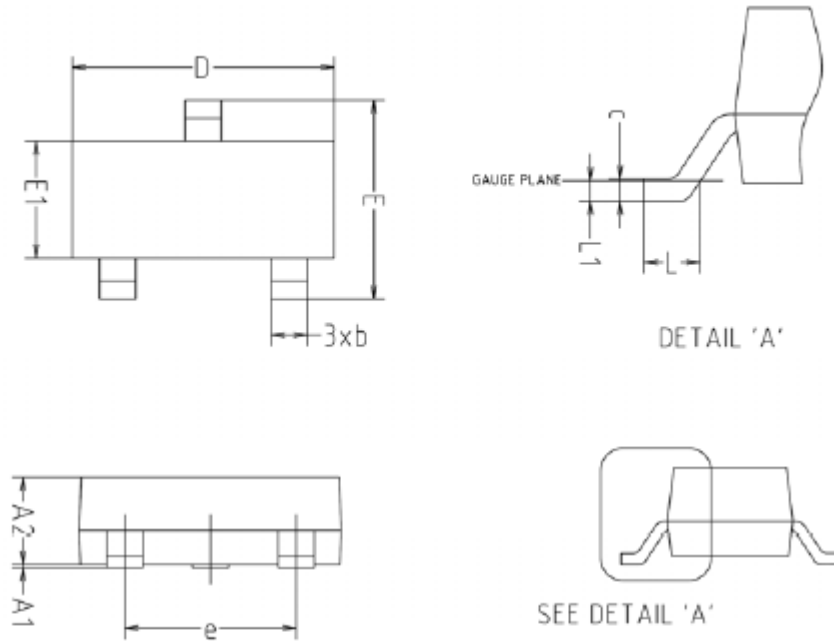

Fig. 5) Reverse recovery time equivalent test circuit



Package Outline Dimensions



| SYMBOL | MILLIMETERS | | | NOTE |
|--------|-------------|---------|---------|------|
| | MINIMUM | NOMINAL | MAXIMUM | |
| A1 | 0.00 | - | 0.10 | |
| A2 | 0.82 | - | 1.02 | |
| b | 0.39 | 0.42 | 0.45 | |
| c | 0.09 | 0.12 | 0.15 | |
| D | 2.80 | 2.90 | 3.00 | |
| E | 2.20 | 2.40 | 2.60 | |
| E1 | 1.20 | 1.30 | 1.40 | |
| e | 1.90BSC | | | |
| L | 0.20 | - | - | |
| L1 | 0.12BSC | | | |

※ Recommend PCB solder land (Unit : mm)

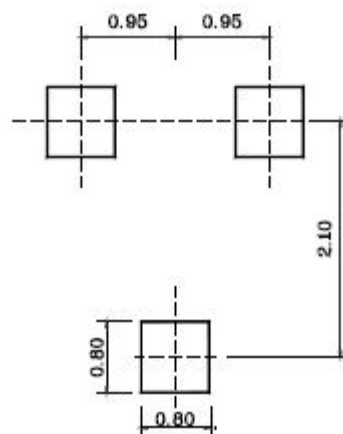

The AUK Dalian Corp. products are intended for the use as components in general electronic equipment (Office and communication equipment, measuring equipment, home appliance, etc.).

Please make sure that you consult with us before you use these AUK Dalian Corp. products in equipments which require high quality and / or reliability, and in equipments which could have major impact to the welfare of human life(atomic energy control, airplane, spaceship, transportation, combustion control, all types of safety device, etc.). AUK Dalian Corp. cannot accept liability to any damage which may occur in case these AUK Dalian Corp. products were used in the mentioned equipments without prior consultation with AUK Dalian Corp..

Specifications mentioned in this publication are subject to change without notice.