



Document Number: 0017SP0001-0217

Revision: 2.1.0 12/2017

AK1052D Mobile Multimedia Application Processor Specification

Table of Contents

1	Introduction	1-1
1.1	Features	1-1
1.2	Applications	1-2
1.3	Product Documentation.....	1-2
1.4	Ordering Information	1-2
1.5	Part Number Information.....	1-3
2	Signals and Connections	2-4
2.1	Pin Definitions	2-4
2.2	Shared-pin List	2-2
3	Electrical Specifications	3-1
3.1	Maximum Ratings	3-1
3.2	Recommended Operating Range	3-1
3.3	Electrical Characteristics of PMU.....	3-2
3.4	DC Electrical Characteristics.....	3-5
3.5	AC Electrical Characteristics.....	3-5
3.6	Bluetooth RF Characteristics	3-6
3.7	Analog Interface Characteristics	3-6
3.8	Power-down and Sniff Supply Current.....	3-6
4	Package Information	4-8
4.1	Pin Assignment	4-8
4.2	Package Information	4-9
5	Reflow Profile	5-11
6	Storage and Baking	6-13

The copyright reserved by Anyka Technologies Corporation. Reproduction or distribution of this document and its content is prohibited without written confirmation of Anyka.

All intellectual property right relating to this document and its content reserved by Anyka Technologies Corporation or legally authorized by its partners.

THE INFORMATION IS PROVIDED WITHOUT ANY EXPRESS OR IMPLIED WARRANTY OF ANY KIND INCLUDING WITHOUT LIMITATION WARRANTIES OF MERCHANTABILITY, FITNESS FOR ANY PARTICULAR PURPOSE, OR NONINFRINGEMENT OF INTELLECTUAL PROPERTY OF ANY THIRD PARTY RELATING TO ANYKA PRODUCTS. IN NO EVENT SHALL ANYKA BE LIABLE FOR ANY DAMAGES WHATSOEVER ARISING OUT OF THE USE OR EXECUTION OF THIS DOCUMENT AND ITS CONTENT

This document provides the information "AS IS". Anyka may make changes to this document, or to specifications, product descriptions, and plans described therein at any time, without notice.

Contact Information

Anyka (Guangzhou) Microelectronics Technology Co., Ltd

3/F, Block C1, No.182 Science Rd,

Guangzhou, Guangdong 510663

P.R. China

Tel: (86)-20-3221 9000

Fax: (86)-20-3221 9258

Sales Hotline:

(86)-20-3221 9499

E-mail:

sales@anyka.com

Home Page:

<http://www.anyka.com>

Document Revision History

The following table provides revision history for this release. This history includes technical content revisions only and not stylistic or grammatical changes.

VERSION	DESCRIPTION	DATE COMPLETED
2.0.0	Initial release	July, 2017
2.1.0	Section 1 Modified the introduction of AK1052D.	December, 2017

About This Manual

This document is the electrical and mechanical specification data sheet for the AK1052D processor. This specification contains a functional overview, mechanical data, package signal locations, electrical specifications (simulated), and bus functional waveforms.

Anyka Confidential For
Onway Use Only

Definitions, Acronyms, and Abbreviations

Unless otherwise specified, all the acronyms and abbreviations used in this manual are defined hereunder.

ADC	Analog to Digital Converter
AHB	Advanced High-performance Bus
ASIC	Application-Specific Integrated Circuit, refers to all the functional blocks of the processor
CMOS	Complimentary Metal-Oxide Semiconductor
CRC	Cyclic Redundancy Check
DAC	Digital to Analog Converter
DMA	Direct Memory Access
DTE	Data Terminal Equipment
ECC	Error Correction Code
FIFO	First In First Out
GPIO	General Purpose Input/Output
TWI	Two Wire Interface
JTAG	Joint Test Action Group
LCD	Liquid Crystal Display
LSB	Least Significant Bit
MMC	Multimedia Card
MMU	Memory Management Unit
MSB	Most Significant Bit
PCM	Pulse Code Modulation
PGA	Programmable Gain Amplifier
PWM	Pulse-Width Modulator
PLL	Phase Locked Loop
RAM	Random Access Memory
ROM	Read Only Memory
SD	Secure Digital
UART	Universal Asynchronous Receiver/Transmitter
USB	Universal Serial Bus
XTAL	Crystal

1 Introduction

AK1052D is an Anyka's highly integrated and cost effective system-on-chip solution based on Bluetooth 5.0/4.2/3.0/2.1+EDR. Positioning at Bluetooth applications such as Bluetooth stereo speakers, earphones, AK1052D satisfies the market with high performance, low cost, and low power consumption.

AK1052D uses ARM926EJ-S core and integrates audio codec, Bluetooth RF, Bluetooth baseband, USB 2.0 Host/Slave controller, SD controller, and power management unit (PMU) into a single chip, offering high multimedia performance and high system integration at reduced power consumption and cost of bill-of-materials (BOM). A set of peripheral interfaces, including UART, IrDA, SPI, SD, I2S, TWI, and USB2.0, feature AK1052D with high extensibility and flexibility.

1.1 Features

- ARM926EJ-S core, 16KB I cache and 4KB D cache
- Up to 200MHz CPU CLK and 100MHz system operating frequency
- Bluetooth Baseband
- Bluetooth RF
- Advanced power management module
- Supports little-endian only
- Software TWI
- Three ADCs, 2 Sigma-Delta ADC for voice/music recording; 1 SAR ADC for analog keypad, battery measurement, and general purpose
- Two Built-in Sigma-Delta DACs
- Headphone driver output
- Two I2S interfaces
- Three UARTs: UART0, UART1, and UART2 (with hardware flow control)
- One SPI Flash controller:
 - Provides one SPI master interface for SPI NOR Flash
 - Supports Standard SPI, Dual SPI, and Quad SPI
 - Supports execute in place (XIP) mode
- One general SPI interface (SPI1), supporting master-slave mode
- One SD interface, compatible with SD 2.0

- One USB2.0 Full-Speed Host & Slave interface
- Supports seven-segment LCD
- 22 GPIOs, all shared with other pins
- JTAG supporting in-circuit debugging
- On-chip PLL and 32.768KHz RTC
- Six PWM outputs
- Three General Purpose timers
- One Watchdog timer
- Two bootstrap modes: SPI NOR Flash Boot and USB Mass Storage Boot
- Package: 48-pin QFN.

1.2 Applications

- Bluetooth stereo speakers
- LED Bluetooth speakers
- Bluetooth speaker smart touch lamp
- Bluetooth stereo earphones
- Bluetooth dialers
- Bluetooth tools

1.3 Product Documentation

The following document(s) is (are) required for a complete description of the AK1052D and are necessary to design properly with the device.

- *AK1052D Programmer's Guide*

1.4 Ordering Information

PART NUMBER	PACKAGE TYPE	OPERATING VOLTAGE	ORDER NUMBER
AK1052DN048	48-PIN QFN	I/O: 3.3V, core: 1.2V	-

1.5 Part Number Information

As shown in Figure 1-1, the Part Number information consists of three lines. The first line symbolizes ANYKA; the second line indicates the product ID, while the third line is production lot number, which is reserved by the producer for specific purposes.

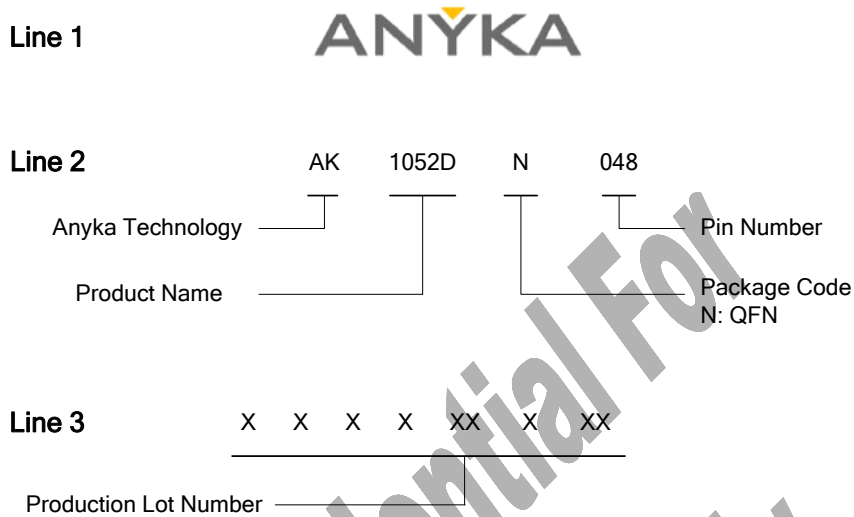

Figure 1-1 Part Number Information

2 Signals and Connections

2.1 Pin Definitions

Table 2-1 identifies and describes the AK1052D signals that are assigned to package pins. I: input; O: output; IO: input/output; PWR: power supply; GND: ground; A: analog; D: digital. PU: pull-up; PD: pull-down.

Table 2-1 AK1052D Functional Pin Definitions

PIN	PIN NAME	TYPE	WAKEUP	RESET	PIN MUX	DESCRIPTION
1	LineIn_LN/ GPI[0]	I/AD	NO	LineIn_LN	LineIn_LN	Line-in left channel input (negative) to ADC3
					GPI[0]	General purpose input port
2	LineIn_LP/ GPI[1]	I/AD	NO	LineIn_LP	LineIn_LP	Line-in left channel input (positive) to ADC3
					GPI[1]	General purpose input port
3	VCM2/ RESET	IO/A	NO	-	VCM2	1.5V audio codec common mode voltage. It is recommended to connect to a 4.7uF capacitor between this pin and GND
					RESET	Reset pin, active low
4	HP_RP	O/A	NO	-	-	Right channel of headphone output (positive)
5	HP_RN	O/A	NO	-	-	Right channel of headphone output (negative).
6	HP_LN	O/A	NO	-	-	Left channel of headphone output (negative)
7	HP_LP	O/A	NO	-	-	Left channel of headphone output (positive)
8	HPVDD	PWR/A	NO	-	-	3.3V headphone power supply
9	XTAL26MO	O/A	NO	-	-	External 26MHz crystal output
10	XTAL26MI	I/A	NO	-	-	External 26MHz crystal input
11	VDD12_OSC_VCO	PWR/A	NO	-	-	1.2V power supply for crystal oscillator
12	VDD12_RF	PWR/A	NO	-	-	1.2V Bluetooth RF power supply
13	BT_TX/RX	IO/A	NO	-	-	Bluetooth: radio signal (RX/TX)
14	VCC33_RF	PWR/A	NO	-	-	3.3V Bluetooth RF power supply
15	CHG_GATE/ GPI[4]	I/A	YES	CHG_GATE	CHG_GATE	External battery charger control pin
		I/D			GPI[4]	General purpose input port with wakeup function
16	ISENSE/	I/A	NO	ISENSE	ISENSE	External charge current sense input

PIN	PIN NAME	TYPE	WAKEUP	RESET	PIN MUX	DESCRIPTION
	GPIO[30]	IO/D			GPIO[30]	General purpose input/output port
17	ONOFF	I/A	YES	-	-	System on/off signal
18	VBAT	I/A	NO	-	-	Battery voltage input
19	VIN_CHG	I/A	YES	-	-	Voltage input of battery charger
20	XTAL32KO	O/A	NO	-	-	External 32KHz crystal output
21	XTAL32KI	I/A	NO	-	-	External 32KHz crystal input
22	USB_DM	IO/A	NO	-	-	USB Data pin (Data-)
23	USB_DP	IO/A	NO	-	-	USB Data pin (Data+)
24	VDD33	PWR/A	NO	-	-	3.3V IO power supply
25	VDD12	PWR/A	NO	-	-	1.2V power supply for core and PLL
26	SPI0_DOUT(I00)	O/D	NO	I/PU	-	SPI0 serial data output (serial data input/output 0)
27	SPI0_CLK	O/D	NO	O/PU	-	SPI0 serial clock
28	SPI0_HOLD(IO3)/ PWM1/ IrDA_RX/ GPIO[18]/ UART1_RXD/ LCD_SEG6	IO/D	NO	SPI0_HOLD(IO3) I/PU	SPI0_HOLD (IO3)	SPI0 Hold (Serial data input/output 3)
					PWM1	Pulse-Width Modulated output signal
					IrDA_RX	IrDA data input
					GPIO[18]	General purpose input/output port
					UART1_RXD	Receive pin of UART1
					LCD_SEG6	LCD segment 6
29	SPI0_CS	O/D	NO	-	-	SPI0 chip select
30	SPI0_DIN(I01)	IO/D	NO	I/PU	-	SPI0 data input (serial data input/output 1)
31	SPI0_WP(IO2)/ PWM0/ CLK32K_OUT/ GPIO[27]/ UART1_TXD/ LCD_SEG7	IO/D	NO	SPI0_WP(IO2) I/PU	SPI0_WP (IO2)	SPI0 Write Protect (Serial data input/output 2)
					PWM0	Pulse-Width Modulated output signal
					CLK32K_OUT	32KHz clock output
					GPIO[27]	General purpose input/output port
					UART1_TXD	Transmit pin of UART1

PIN	PIN NAME	TYPE	WAKEUP	RESET	PIN MUX	DESCRIPTION
					LCD_SEG7	LCD segment 7
32	GPIO[6]/ UART0_TXD	IO/D	YES	GPIO[6], I/PU	GPIO[6]	General purpose input/output port with wakeup function. GPIO[6] is specially used as a boot mode select pin during system startup.
					UART0_TXD	Transmit pin of UART0
33	GPIO[7]/ UART0_RXD/ SPI1_DOUT(I00)/ IrDA_RX/ I2S0_DOUT/ LCD_SEG5/ PWM1	IO/D	YES	GPIO[7], I/PU	GPIO[7]	General purpose input/output port with wakeup function
					UART0_RXD	Receive pin of UART0
					SPI1_DOUT (I00)	SPI1 serial data output (serial data input/output 0)
					IrDA_RX	IrDA data input
					I2S0_DOUT	I2S0 serial data output
					LCD_SEG5	LCD segment 5
					PWM1	Pulse-Width Modulated output signal
34	GPIO[11]/ LCD_SEG0/ PWM5/ SPI1_CLK/ I2S0_DIN/ UART2_TXD	IO/D	YES	GPIO[11], I/PU	GPIO[11]	General purpose input/output port with wakeup function
					LCD_SEG0	LCD segment 0
					PWM5	Pulse-Width Modulated output signal
					SPI1_CLK	SPI1 serial clock
					I2S0_DIN	I2S0 serial data input
					UART2_TXD	Transmit pin of UART2
35	GPIO[24]/ LCD_SEG1/ PWM0/ SPI1_HOLD (IO3)/ I2S0_BCLK/ UART2_RTS/ AIN1	IO/AD	YES	GPIO[24], I/PD	GPIO[24]	General purpose input/output port with wakeup function
					LCD_SEG1	LCD segment 1
					PWM0	Pulse-Width Modulated output signal
					SPI1_HOLD (IO3)	SPI1 Hold (Serial data input/output 3)
					I2S0_BCLK	I2S0 bit clock
					UART2_RTS	UART2 "Request To Send" signal
					AIN1	A/D input node for general purpose analog input, it could be used for analog keypad input
36	GPIO[13]/	IO/D	YES	GPIO[13],	GPIO[13]	General purpose input/output port with wakeup function

PIN	PIN NAME	TYPE	WAKEUP	RESET	PIN MUX	DESCRIPTION
	LCD_SEG2/ PWM2/ SPI1_CS/ I2S0_LRCLK/ JTAG_TDI			I/PU	LCD_SEG2	LCD segment 2
					PWM2	Pulse-Width Modulated output signal
					SPI1_CS	SPI1 chip select
					I2S0_LRCLK	I2S0 channel selection
					JTAG_TDI	JTAG serial data input
37	GPIO[15]/ I2S0_MCLK/ LCD_SEG3/ SPI1_DIN(IO1)/ PWM3/ UART2_RXD	IO/D	YES	GPIO[15], I/PU	GPIO[15]	General purpose input/output port with wakeup function
					I2S0_MCLK	I2S0 main clock
					LCD_SEG3	LCD segment 3
					SPI1_DIN(IO1)	SPI1 data input (serial data input/output 1)
					PWM3	Pulse-Width Modulated output signal
					UART2_RXD	Receive pin of UART2
38	GPIO[12]/ SPI1_WP(IO2)/ LCD_SEG4/ PWM4/ I2S1_DOUT/ JTAG_RST	IO/D	YES	GPIO[12], I/PU	GPIO[12]	General purpose input/output port with wakeup function
					SPI1_WP(IO2)	SPI1 Write Protect (Serial data input/output 2)
					LCD_SEG4	LCD segment 4
					PWM4	Pulse-Width Modulated output signal
					I2S1_DOUT	I2S1 serial data output
					JTAG_RST	JTAG logic reset, active low
39	GPIO[17]/ I2S1_DIN/ LCD_SEG9/ PWM2 SD_D[3]/ JTAG_TCK	IO/D	YES	GPIO[17], I/PU	GPIO[17]	General purpose input/output port with wakeup function
					I2S1_DIN	I2S1 serial data input
					LCD_SEG9	LCD segment 9
					PWM2	Pulse-Width Modulated output signal
					SD_D[3]	SD data line 3
					JTAG_TCK	JTAG test clock output
40	GPIO[20]/ I2S1_MCLK/ UART1_TXD/ PWM4/	IO/D	YES	GPIO[20], I/PU	GPIO[20]	General purpose input/output port with wakeup function
					I2S1_MCLK	I2S1 main clock
					UART1_TXD	Transmit pin of UART1

PIN	PIN NAME	TYPE	WAKEUP	RESET	PIN MUX	DESCRIPTION
	SD_D[0]/ JTAG_TDO				PWM4	Pulse-Width Modulated output signal
					SD_D[0]	SD data line 0
					JTAG_TDO	JTAG serial data output
41	GPIO[19]/ I2S1_LRCLK/ LCD_SEG11/ PWM5/ SD_CLK/ JTAG_RTCK	IO/D	YES	GPIO[19], I/PU	GPIO[19]	General purpose input/output port with wakeup function
					I2S1_LRCLK	I2S1 channel selection
					LCD_SEG11	LCD segment 11
					PWM5	Pulse-Width Modulated output signal
					SD_CLK	SD operating clock
					JTAG_RTCK	JTAG debug return clock
42	GPIO[14]/ I2S1_BCLK/ LCD_SEG10/ UART2_CTS/ SD_CMD/ JTAG_TMS	IO/D	YES	GPIO[14], I/PU	GPIO[14]	General purpose input/output port with wakeup function
					I2S1_BCLK	I2S1 bit clock
					LCD_SEG10	LCD segment 10
					UART2_CTS	UART2 "Clear to send" signal
					SD_CMD	SD command line
					JTAG_TMS	JTAG test mode select
43	AIN0/ GPIO[10]	I/AD	YES	AIN0	AIN0	A/D input node for general purpose analog input, it could be used for analog keypad input. This pin supports wakeup function.
					GPIO[10]	General purpose input/output port
44	LineIn_RN/ MIC0_P/ GPI[2]	I/AD	NO	LineIn_RN	LineIn_RN	Line-in right channel input (negative) to ADC2
					MIC0_P	Microphone0 right channel input (positive) to ADC2
					GPI[2]	General purpose input port
45	LineIn_RP/ MIC0_N/ GPI[3]	I/AD	NO	LineIn_RP	LineIn_RP	Line-in right channel input (positive) to ADC2
					MIC0_N	Microphone0 right channel input (negative) to ADC2
					GPI[3]	General purpose input port
46	MIC1_P/ GPI[5]	I/AD	NO	MIC1_P	MIC1_P	Microphone1 left channel input (positive) to ADC3
					GPI[5]	General purpose input port

PIN	PIN NAME	TYPE	WAKEUP	RESET	PIN MUX	DESCRIPTION
47	MIC1_N/ GPI[6]	I/AD	NO	MIC1_N	MIC1_N	Microphone1 left channel input (negative) to ADC3
					GPI[6]	General purpose input port
48	VCM3/ VDD_MIC	IO/A	NO	-	VCM3	3.0V reference voltage for audio codec
					VDD_MIC	3.0V microphone bias output
49	GND	GND/D	NO-	-	-	Power ground. Connect this pin to the ground on the Printed Circuit Board.

Anyka Confidential For
Onway Use Only

Notes:

1. As shown in the **WAKEUP** column of the table above, YES denotes the corresponding GPIO or dedicated pin is a wakeup pin, which can be applied to wakeup the processor from standby. NO denotes the corresponding pin is not a wakeup pin.
2. The pull-up/pull-down resistance range of GPIOs or specified pins are shown in the following table. The pull-up/pull-down function attached to GPIOs can be enabled / disabled by software.

Table 2-2 Resistance range of pull-up and pull-down pins

PIN NAME	PU/PD	PU/PD RESISTOR
GPIO[7], SPI0_WP(I02), SPI0_HOLD(I03), GPIO[13:11], GPIO[15], GPIO[20]	PU	70KΩ ± 40%
GPIO[14], GPIO[19]	PU	28KΩ ± 60%
GPI[4]	PU	40K±15%
GPIO[24], GPIO[17]	PU/PD programmable	PU: 70KΩ ±40% PD: 300KΩ ±40%
USB_DP, USB_DM	PU/PD programmable	PU: 1.5K +/- 15% PD: 15K+/- 15%
GPIO[6], SPI0_CLK, SPI0_CS, SPI0_DIN(I01), SPI0_DOUT(I00),	PU	62KΩ~ 112KΩ

Note: AINO/GPIO[10] and ISENSE/GPIO[30] are open-drain outputs when they are worked as GPO. In this case, an external pull-up resistor is required to connect to VDD33/VBAT.

3. Recommended circuit of the 32K crystal:

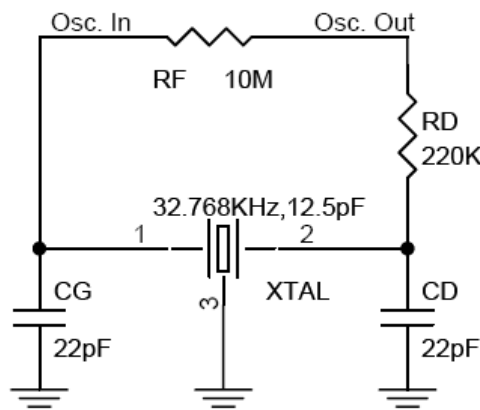

4. Table 2-3 shows the drive strength of GPIOs and SPI pins.

Table 2-3 AK1052D GPIO Drive Strength (3.3V power supply)

PARAMETER	PIN	DRIVE STRENGTH		
		MINIMUM	TYPICAL	MAXIMUM
Low level output current ($I_{ol}@VOL = 0.4V$)	GPIO[30] (default as ISENSE), GPIO[10](default as AIN0)	-	-	1.5mA
	GPIO[24], GPIO[20:19], GPIO[17], GPIO[15:11], GPIO[7:6], SPI0_CS, SPI0_DOUT (IO0), SPI0_DIN (IO1), SPI0_WP(IO2)/GIPO[27], and SPI0_HOLD(IO3)/GPIO[18]	-	6mA	-
	SPI0_CLK	-	13mA	-
	LCD_SEG[11:9], and LCD_SEG[7:0]	-	Seven-segment LCD mode : 26mA Other modes: 6mA	-
High level output current ($I_{oh}@VOH = 2.4V$)	GPIO[30] (default as ISENSE), GPIO[10](default as AIN0)	-	-	1.5mA
	GPIO[24], GPIO[20:19], GPIO[17], GPIO[15:11], GPIO[7:6], SPI0_CS, SPI0_DOUT(IO0), SPI0_DIN (IO1), SPI0_WP(IO2)/GIPO[27], SPI0_HOLD(IO3)/GPIO[18], LCD_SEG[11:9], and LCD_SEG[7:0]	-	10mA	-
	SPI0_CLK	-	20mA	-

Table 2-4 classifies the AK1052D signals according to different modules.

Table 2-4 AK1052D Functional Pin Classification

Module	PIN NAME	Module	PIN NAME
1. System Control(6)	ONOFF		I2S0_DIN
	XTAL32KI		I2S0_DOUT
	XTAL32KO		I2S1_MCLK
	XTAL26MI		I2S1_BCLK
	XTAL26MO		I2S1_LRCLK
	CLK32K_OUT		I2S1_DIN
2. USB Interface(2)	USB_DM		I2S1_DOUT
	USB_DP		8. PWM(6)
3. Bluetooth(1)	BT_TX/RX	JTAG_TMS	
4. SPI(12)	SPI0_CLK	#JTAG_RST	
	SPI0_CS	JTAG_TDO	
	SPI0_DIN (IO1)	JTAG_RTCK	
	SPI0_DOUT (IO0)	JTAG_TCK	
	SPI0_WP (IO2)	JTAG_TDI	
	SPI0_HOLD (IO3)	10. GPIO(22)	GPIO[30]
	SPI1_CLK		GPIO[27]
	SPI1_CS		GPIO[24]
	SPI1_DIN (IO1)		GPIO[17:20]
	SPI1_DOUT (IO0)		GPIO[10:15]
	SPI1_WP (IO2)		GPIO[6:7]
	SPI1_HOLD (IO3)	GPI[6:0]	
5. IrDA(1)	IrDA_RX	11.Audio Analog Interface(14)	AIN0
6. SD Interface(4)	SD_CLK		AIN1
	SD_CMD		HP_LP
	SD_D[3]		HP_LN
	SD_D[0]		HP_RN
7. I2S(10)	I2S0_MCLK		HP_RP
	I2S0_BCLK		LINEIN_LP
	I2S0_LRCLK	LINEIN_LN	

Module	PIN NAME	Module	PIN NAME
	LINEIN_RN		VIN_CHG
	LINEIN_RP		ISENSE
	MIC0_P		CHG_GATE
	MIC0_N	14. Power and Grounds (9)	HPVDD
	MIC1_P		VDD12
	MIC1_N		VDD33
12. UART(8)	UART0_TXD		VCM3/VDD_MIC
	UART0_RXD		VCM2
	UART1_TXD		VDD12_OSC_VCO
	UART1_RXD	VDD12RF	
	UART2_CTS	VCC33_RF	
	UART2_RTS	GND	
	UART2_TXD		
	UART2_RXD		
13. PMU (4)	VBAT		

2.2 Shared-pin List

In order to reduce pin numbers, many pins are shared by more than one function blocks that would not be implemented at the same time. The table below lists the shared pins. All the shared pins are configured by Shared-Pin Control Register.

Table 2-5 AK1052D Shared-pin List

Shared-pin	MODULE	PIN Name	RESET
1	Analog	LineIn_LN	LineIn_LN
	GPIO	GPI[0]	
2	Analog	LineIn_LP	LineIn_LP
	GPIO	GPI[1]	
15	Charger	CHG_GATE	CHG_GATE
	GPI	GPI[4]	
16	Charger	ISENSE	ISENSE
	GPIO	GPIO[30]	

Shared-pin	MODULE	PIN Name	RESET
28	SPI	SPI0_HOLD(IO3)	SPI0_HOLD(IO3)
	PWM	PWM1	
	IrDA	IrDA_RX	
	GPIO	GPIO[18]	
	UART	UART1_RXD	
	LCD segment	LCD_SEG6	
31	SPI	SPI0_WP(IO2)	SPI0_WP(IO2)
	PWM	PWM0	
	System	CLK32K_OUT	
	GPIO	GPIO[27]	
	UART	UART1_TXD	
	LCD segment	LCD_SEG7	
32	GPIO	GPIO[6]	GPIO[6]
	UART	UART0_TXD	
33	GPIO	GPIO[7]	GPIO[7],
	UART	UART0_RXD	
	SPI	SPI1_DOUT(IO0)	
	IrDA	IrDA_RX	
	I2S	I2S0_DOUT	
	LCD segment	LCD_SEG5	
	PWM	PWM1	
34	GPIO	GPIO[11]	GPIO[11]
	LCD segment	LCD_SEG0	
	PWM	PWM5	
	SPI	SPI1_CLK	
	I2S	I2S0_DIN	
	UART	UART2_TXD	
35	GPIO	GPIO[24]	GPIO[24]
	LCD segment	LCD_SEG1	
	PWM	PWM0	
	SPI	SPI1_HOLD(IO3)	

Shared-pin	MODULE	PIN Name	RESET
	I2S	I2S0_BCLK	
	UART	UART2_RTS	
	SAR ADC	AIN1	
36	GPIO	GPIO[13]	GPIO[13]
	LCD segment	LCD_SEG2	
	PWM	PWM2	
	SPI	SPI1_CS	
	I2S	I2S0_LRCLK	
	JTAG	JTAG_TDI	
37	GPIO	GPIO[15]	GPIO[15]
	I2S	I2S0_MCLK	
	LCD segment	LCD_SEG3	
	SPI	SPI1_DIN(IO1)	
	PWM	PWM3	
	UART	UART2_RXD	
38	GPIO	GPIO[12]	GPIO[12]
	SPI	SPI1_WP(IO2)	
	LCD segment	LCD_SEG4	
	PWM	PWM4	
	I2S	I2S1_DOUT	
	JTAG	JTAG_RST	
39	GPIO	GPIO[17]	GPIO[17]
	I2S	I2S1_DIN	
	LCD segment	LCD_SEG9	
	PWM	PWM2	
	SD	SD_D[3]	
	JTAG	JTAG_TCK	
40	GPIO	GPIO[20]	GPIO[20]
	I2S	I2S1_MCLK	
	UART	UART1_TXD	
	PWM	PWM4	

Shared-pin	MODULE	PIN Name	RESET
	SD	SD_D[0]	
	JTAG	JTAG_TDO	
41	GPIO	GPIO[19]	GPIO[19]
	I2S	I2S1_LRCLK	
	LCD segment	LCD_SEG11	
	PWM	PWM5	
	SD	SD_CLK	
	JTAG	JTAG_RTCK	
42	GPIO	GPIO[14]	GPIO[14]
	I2S	I2S1_BCLK	
	LCD segment	LCD_SEG10	
	UART	UART2_CTS	
	SD	SD_CMD	
	JTAG	JTAG_TMS	
43	SAR ADC	AIN0	AIN0
	GPIO	GPIO[10]	
44	Analog	LineIn_RN	LineIn_RN
	Analog	MIC0_P	
	GPI	GPI[2]	
45	Analog	LineIn_RP	LineIn_RP
	Analog	MIC0_N	
	GPI	GPI[3]	
46	Analog	MIC1_P	MIC1_P
	GPI	GPI[5]	
47	Analog	MIC1_N	MIC1_N
	GPI	GPI[6]	

3 Electrical Specifications

3.1 Maximum Ratings

Stresses greater than those listed may cause permanent damage to the device. This is a stress rating only, and functional operation of the device at these or any other conditions outside those indicated in the operational sections of this specification are not implied. Exposure to absolute maximum rating conditions for extended period may affect reliability.

Table 3-1 AK1052D Maximum Ratings

PARAMETER	SYMBOL	MINIMUM	MAXIMUM	UNIT
VDD12 supply voltage relative to GND	VDD12	-0.3	1.4	V
VDD33 supply voltage relative to GND	VDD33	-0.3	4.0	V
AVDD_MIC supply voltage relative to GND	AVDD_MIC	-0.3	4.0	V
AVCC_USB supply voltage relative to GND	AVCC_USB	-0.3	4.0	V
AVCC supply voltage relative to GND	AVCC	-0.3	4.0	V
HPVDD supply voltage relative to GND	HPVDD	-0.3	4.0	V
VDD12_RF supply voltage relative to GND	VDD12_RF	-0.3	1.4	V
VCC33_RF supply voltage relative to GND	VCC33_RF	-0.3	4.0	V
VBAT supply voltage relative to GND	VBAT	-0.3	4.5	V
VIN_CHG supply voltage relative to GND	VIN_CHG	-0.3	5.5	V
Storage Temperature	T _s	-40	125	°C

3.2 Recommended Operating Range

Table 3-2 Recommended Operating Range

PARAMETER	SYMBOL	MINIMUM	TYPICAL	MAXIMUM	UNIT
VDD12 supply voltage relative to GND	VDD ²	1.08	1.2	1.35	V

PARAMETER	SYMBOL	MINIMUM	TYPICAL	MAXIMUM	UNIT
VDD33 supply voltage relative to GND	VDD33	2.97	3.30	3.63	V
AVDD_MIC supply voltage relative to GND	AVDD_MIC	2.97	3.0	3.63	V
VCCA_USB supply voltage relative to GND	VCCA_USB	2.97	3.30	3.63	V
AVCC supply voltage relative to GND	AVCC	2.85	3.0	3.1	V
HPVDD supply voltage relative to GND	HPVDD	3.2	3.3	3.6	V
VDD12_RF supply voltage relative to GND	VDD12_RF	1.15	1.3	1.4	V
VCC33_RF supply voltage relative to GND	VCC33_RF	2.8	3.0	3.30	V
VBAT supply voltage relative to GND	VBAT	3.5	-	4.5	V
VIN_CHG supply voltage relative to GND	VIN_CHG	3.5	-	5.0	V
Operating Temperature Range	T _o	0	-	75	°C

Notes:

1. In normal mode, the recommended operating range of VDD12 is given in the table.
2. In standby mode, VDD12 is recommended to set as 1.1V to save power.

3.3 Electrical Characteristics of PMU

Table 3-3 Electrical Characteristics of LDO12

Typical values are at T_A = +27°C and all Current Values are dynamic, unless other-wise noted.

Symbol	Parameter	Conditions	Min	Typ	Max	Unit
V _{in}	Input voltage	-	2.5	3.3	3.7	V
V _{out} (accuracy)	Output voltage	Default	-3	-	+3	%
V _{out}	Output voltage	-	-	1.2	1.35	V
I _{out}	Output current	-	-	100	150	mA
Δ V _{out} ,	Load regulation	T=27 °C, V _{in} =3.3V,	-	38	-	mV

Symbol	Parameter	Conditions	Min	Typ	Max	Unit
$\Delta V_{out}/\Delta I_{out}$		@ $I_{out}=1$ to 100mA	-	330	-	m Ω
ΔV_{out} , $\Delta V_{out}/\Delta V_{in}$	Line regulation	$I_{out}=1$ mA	-	3	-	mV
		@ $V_{in}=3.0$ V to 3.7V	-	0.2	-	%
		$I_{out}=100$ mA	-	8	-	mV
		@ $V_{in}=3.0$ V to 3.7V	-	0.5	-	%
I_{cc}	V_{in} Quiescent Current	No load	-	50	-	μ A
I_{pd}	Power-down current	-	-	0.1	-	μ A

Table 3-4 Electrical Characteristics of LDO33

Typical values are at $T_A = +27^\circ\text{C}$ and all Current Values are dynamic, unless other-wise noted.

Symbol	Parameter	Conditions	Min	Typ	Max	Unit
V_{in}	Input voltage	-	3.5	3.7	5.0	V
V_{out} (accuracy)	Output voltage	Default	-3	-	+3	%
V_{out}	Output voltage	-	-	3.3	-	V
I_{out}	Output current	-	-	-	250	mA
ΔV_{out} , $\Delta V_{out}/\Delta I_{out}$	Load regulation	$T=27^\circ\text{C}$, $V_{in}=3.8$ V, @ $I_{out}=1$ to 100mA	-	40	-	mV
			-	340	-	m Ω
ΔV_{out} , $\Delta V_{out}/\Delta V_{in}$	Line regulation	$I_{out}=1$ mA	-	3	-	mV
		@ $V_{in}=3.5$ to 5V	-	0.2	-	%
		$I_{out}=250$ mA	-	10	-	mV
		@ $V_{in}=3.5$ V to 5V	-	0.5	-	%
I_{cc}	V_{in} Quiescent Current	No load	-	50	-	μ A
I_{pd}	Power-down current	-	-	0.1	-	μ A

Table 3-5 Electrical Characteristics of LDO33RF

Typical values are at $T_A = +27^\circ\text{C}$ and all Current Values are dynamic, unless other-wise noted.

Symbol	Parameter	Conditions	Min	Typ	Max	Unit
Vin	Input voltage	-	3.2	3.8	4.5	V
Vout (accuracy)	Output voltage	Default	-3	-	3	%
Vout	Output voltage	-	-	3.0	-	V
Iout	Output current	-	-	50	80	mA
ΔV_{out} , $\Delta V_{out}/\Delta I_{out}$	Load regulation	T=27 °C, Vin=3.8V, @Iout=1 to 50mA	-	10	-	mV
			-	500	-	mΩ
ΔV_{out} , $\Delta V_{out}/\Delta V_{in}$	Line regulation	Iout=1mA	-	5	-	mV
		@Vin=3.8 to 4.5V	-	0.2	-	%
		Iout = 50mA @Vin=3.8V to 4.5V	-	20	-	mV
			-	0.5	-	%
Icc	Vin Quiescent Current	No load	-	50	-	μA
Ipd	Power-down current	-	-	0.1	-	μA

Table 3-6 Electrical Characteristics of LDO12RF

Typical values are at $T_A = +27^\circ\text{C}$ and all Current Values are dynamic, unless other-wise noted.

Symbol	Parameter	Conditions	Min	Typ	Max	Unit
Vin	Input voltage	-	2.5	3.3	3.7	V
Vout (accuracy)	Output voltage	Default	-3	-	3	%
Vout	Output voltage	-	1.1	1.3	1.4	V
Iout	Output current	-	-	80	100	mA
ΔV_{out} , $\Delta V_{out}/\Delta I_{out}$	Load regulation	T=27 °C, Vin=3.8V, @Iout=1 to 100mA	-	38	-	mV
			-	330	-	mΩ
ΔV_{out} , $\Delta V_{out}/\Delta V_{in}$	Line regulation	Iout=1mA @Vin=3.3 to 3.7V	-	3	-	mV
			-	0.2	-	%

Symbol	Parameter	Conditions	Min	Typ	Max	Unit
		I _{out} =100mA @V _{in} =3.3V to 3.7V	-	8	-	mV
			-	0.5	-	%
I _{cc}	V _{in} Quiescent Current	No load	-	50	-	μA
I _{pd}	Power-down current	-	-	0.1	-	μA

3.4 DC Electrical Characteristics

Table 3-7 DC Electrical Characteristics

PARAMETER	SYMBOL	MINIMUM	TYPICAL	MAXIMUM	UNIT
Input High Voltage	V _{IH}	2.0	-	V _{DD33} +0.3	V
Input Low Voltage	V _{IL}	-0.3	-	0.8	V
Output High Voltage	V _{OH}	2.4	-	-	V
Output Low Voltage	V _{OL}	-	-	0.4	V
Input Leakage Current	I _L	-	-	±1	μA
Tri-state Output Leakage Current	I _{OZ}	-	-	±1	μA
Input capacitance	C _I	-	-	8	pF
Output capacitance	C _O	-	-	8	pF
Analog Line in Resistance	R _L	-	18K	-	Ω
Microphone Input Resistance	R _{mic}	-	5K	-	Ω
Headphone output load resistance	R _{HP}	-	32	-	Ω

3.5 AC Electrical Characteristics

Table 3-8 32K/26M Oscillator Signal Timing

PARAMETER	MIN.	TYP.	MAX.	UNIT
XTAL32K Startup Time	-	500	-	ms
XTAL26M Startup Time	-	8	-	ms

3.6 Bluetooth RF Characteristics

Table 3-9 RF TX Characteristics

PARAMETER	UNIT	MIN..	TYP.	MAX.	REFERENCE
Output Power	dBm	-3	2	6	-
Power Control	dB	-	24	-	>=16
Frequency Range	GHz	2.4	-	2.4835	2.4~2.4835
Initial Carrier Frequency Tolerance	KHz	-50	-	50	-75~75
Carrier Frequency Drift	KHz/50us	-	5	20	<=20

Table 3-10 RF RX Characteristics

PARAMETER	UNIT	MIN.	TYP.	MAX.	REFERENCE
Sensitivity	dBm	-	-80	-	<=-70
Maximum Input Level	dBm	-20	-	-	>=-20

3.7 Analog Interface Characteristics

Table 3-11 Analog Interface Characteristics

PARAMETER	SYMBOL	MINIMUM	TYPICAL	MAXIMUM	UNIT
Analog Line in Resistance	R _L	6.3K	18K	30K	Ω
Microphone Input Resistance	R _{mic}	-	5K	-	Ω
Headphone output load resistance	R _{HP}	-	External connected	-	Ω

3.8 Power-down and Sniff Supply Current

Table 3-12 Power-down and Sniff Supply Current

PARAMETER	MINIMUM	TYPICAL	MAXIMUM	UNIT
Supply current in power down mode (RTC module is powered off)	-	0	-	μA

PARAMETER	MINIMUM	TYPICAL	MAXIMUM	UNIT
Supply current in power down mode (RTC module is powered on)	-	20	-	μA
Supply current in sniff mode	-	1	-	mA

Notes:

1. Power-down: RTC module can be configured to be powered on by 3.3V voltage or powered off, while all the other modules are powered off.
2. Sniff: If Bluetooth module works in deep-sleep state of the sniff interval, the PLL is powered down and other modules (including CPU core) are clocked off. If Bluetooth module works in wakeup state of the sniff interval, Bluetooth module manages data transmission between slaves and masters, while other modules are clocked off.

Anyka Confidential For
Onway Use Only

4 Package Information

AK1052D is packaged in a 48-pin QFN with 6mm x 6mm x 0.85mm.

4.1 Pin Assignment

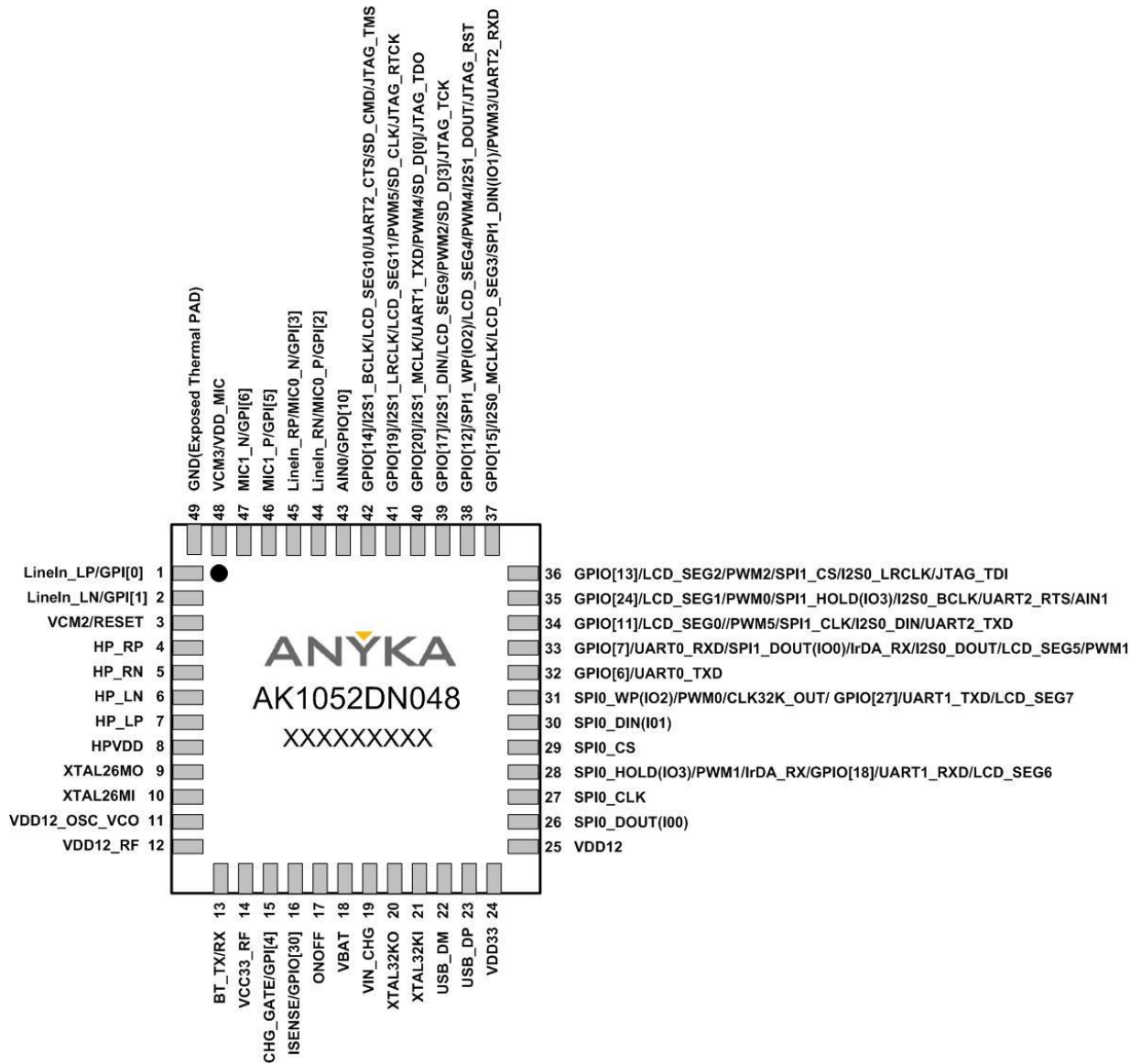

4.2 Package Information

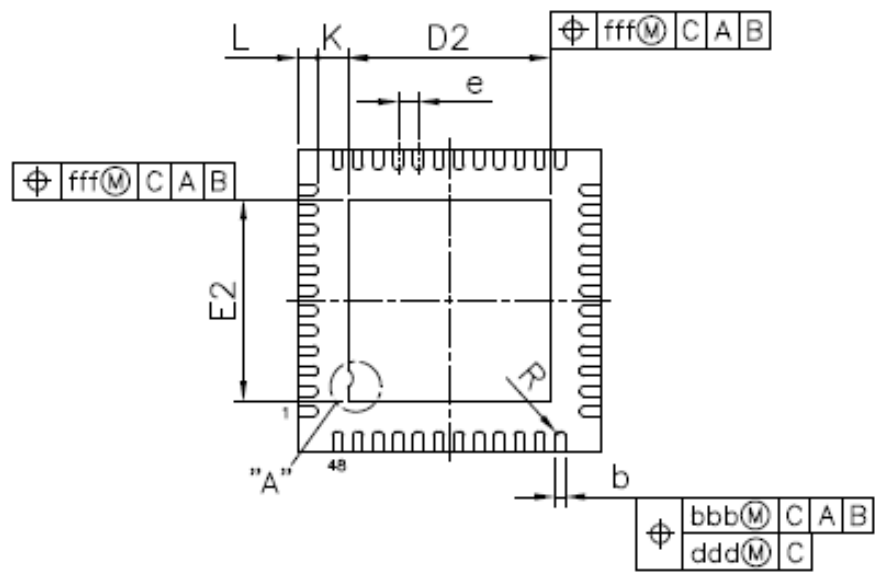
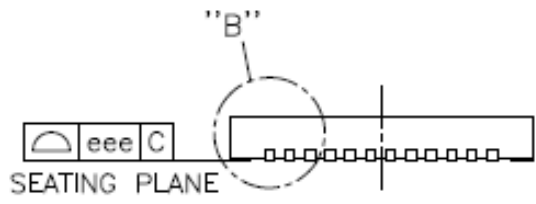
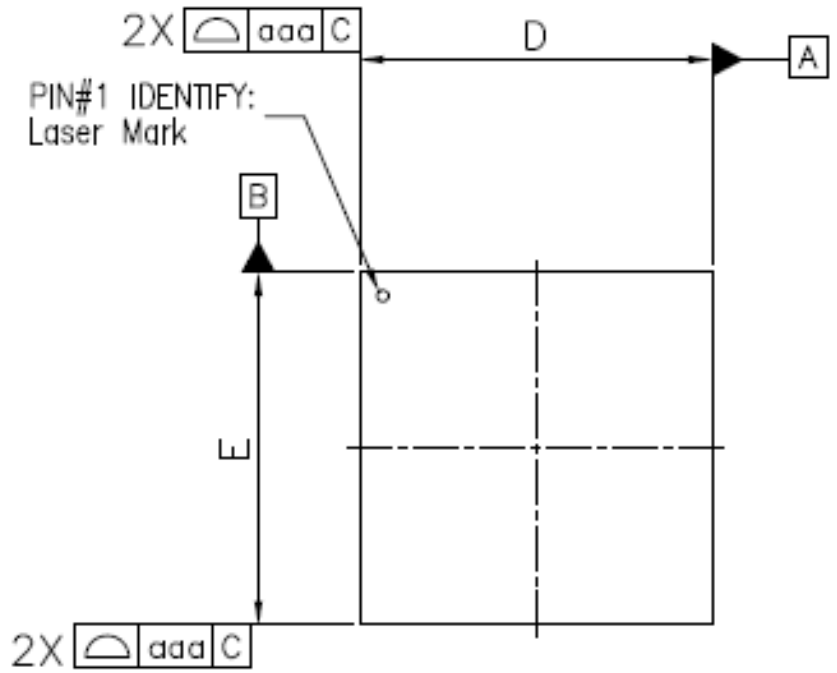

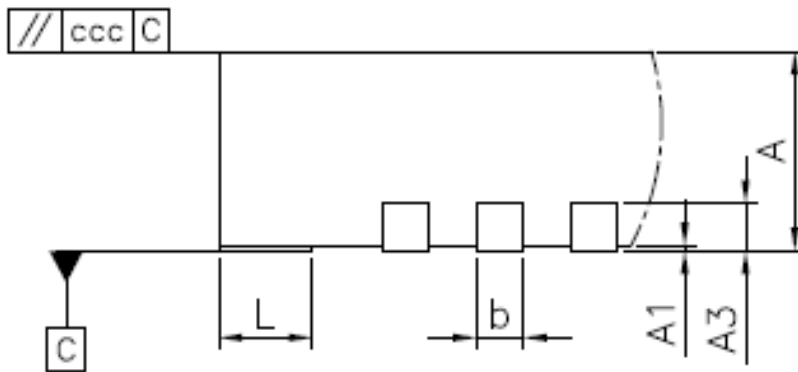

DETAIL : "B"

Symbol	DIMENSION (millimeter)		
	MIN	NOM	MAX
A	0.80	0.85	0.90
A1	0.00	0.02	0.05
A3	0.20REF		
b	0.15	0.20	0.25
D/E	5.90	6.00	6.10
D2/E2	3.85	4.00	4.15
e	0.40 BSC		
L	0.30	0.40	0.50
K	0.20	-	-
R	0.075	-	-
aaa	0.10		
bbb	0.07		
ccc	0.10		
ddd	0.05		
eee	0.08		
fff	0.10		

5 Reflow Profile

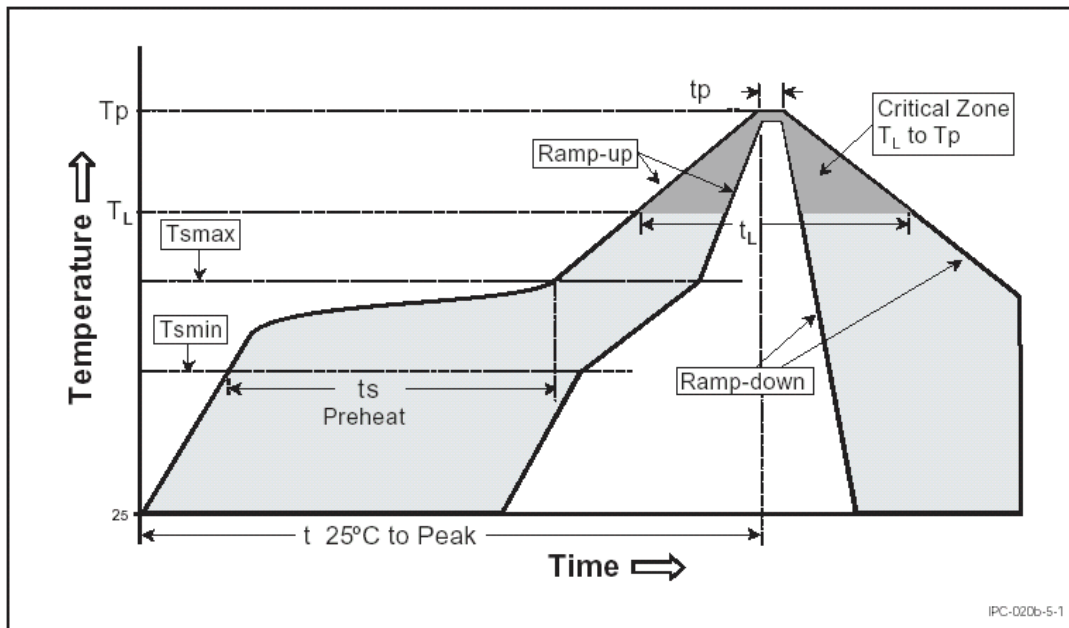

Figure 5-1 Recommended Reflow Profile

Table 5-1 Reflow Profile Condition

Profile Feature	Pb-Free Assembly
Average ramp-up rate (T _{smax} to T _p)	2 °C/second max
Preheat -Temperature Min(T _{smin}) -Temperature Max(T _{smax}) -Time (min to max) (t _s)	150 °C 200 °C 60 - 180 seconds
Time maintained above: -Temperature (T _L) -Time (t _L)	217 °C 60 - 150 seconds
Peak Temperature (T _p)	245+5/-5 °C
Time within 5°C of actual Peak Temperature(t _p)	30 seconds max
Ramp-down Rate	3°C/second max

Profile Feature	Pb-Free Assembly
Time 25°C to Peak Temperature	8 minutes max

Note: All temperatures refer to topside of the package, measured on the package body surface.

Anyka Confidential For
Onway Use Only

6 Storage and Baking

1. Shelf life in sealed bag: 12 months at $< 30^{\circ}\text{C}$ and $< 60\%$ relative humidity (RH).
2. After bag is opened, device that will be subjected to reflow solder or other high temperature process must be:
 - a) Mounted within: 168 hours of factory conditions $< 30^{\circ}\text{C}/60\%$ RH or
 - b) Stored at $< 20\%$ RH.
3. Devices require bake, before mounting, if:
 - a) Humidity indicator card reads $\geq 20\%$ when read at $25\pm 5^{\circ}\text{C}$;
 - b) 2a or 2b are not met.
4. If baking is required, device may be baked for 12 hours at $125^{\circ}\text{C}\pm 5^{\circ}\text{C}$.

Anyka Confidential For
Onway Use Only