

### Features

- **Low Noise:** 13nV/√Hz(f= 1kHz)
- **Supply Current:** 190µA/ch
- **Offset Voltage:** 1 mV (max)
- **Low THD+N:** 0.0005%
- **Supply Range:** 2.2V to 5.5V
- **Low Input Bias Current:** 0.3pA Typical
- **EMIRR IN+:** 85 dB( under 2.4GHz)
- **Slew Rate:** 0.9 V/µs
- **Gain-bandwidth Product:** 1.6MHz
- **Rail-to-Rail I/O**
- **High Output Current:** 70mA (1.0V Drop)
- **-40°C to 125°C Operation Range**
- **Robust 7kV – HBM and 2kV – CDM ESD Rating**

### Applications

- Portable Equipment
- Battery-Powered Instruments
- Data Acquisition and Control
- Low-Voltage Signal Conditioning
- Communications
- Security

### Description

The single TP2431, dual TP2432, and quad TP2434 operational amplifiers combine excellent DC accuracy with Rail-to-Rail operation at the input and output. Since the common-mode voltage extends from VCC to VEE, the devices can operate from either a single supply (2.2V to 5.5V) or split supplies (±1.1V to ±2.75V). Each op amp requires less than 190µA of supply current. Even with this low current, the op amps are capable of driving a 1kΩ load, and the input-referred voltage noise is only 13nV/√Hz. In addition, these op amps can drive loads in excess of 2000pF.

The precision performance of the TP2431/TP2432/TP2434 combined with their wide input and output dynamic range, low-voltage, single-supply operation, and very low supply current, make them an ideal choice for battery-operated equipment, industrial, and data acquisition and control applications.

The TP2431 is single channel version available in 8-pin SOP and 5-pin SOT23 packages. The TP2432 is dual channel version available in 8-pin SOP and MSOP packages. The TP2434 is quad channel version available in 14-pin SOP and TSSOP packages.

3PEAK and the 3PEAK logo are registered trademarks of 3PEAK INCORPORATED. All other trademarks are the property of their respective owners.

### Pin Configuration (Top View)

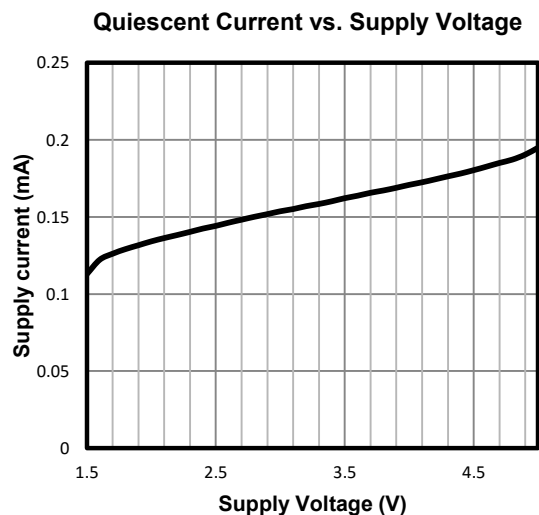
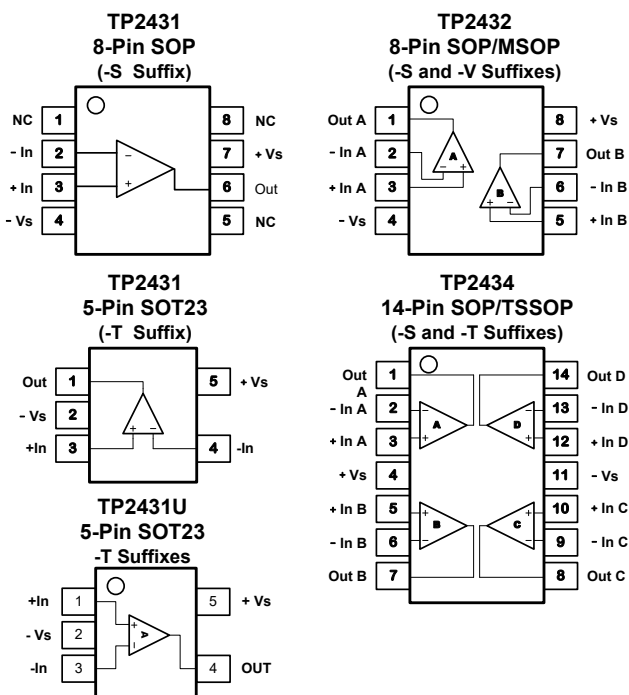

# TP2431 / TP2432 / TP2434

## 1.6MHz Bandwidth, Micropower Low Noise Op-amps

### Order Information

Model Name	Order Number	Package	Transport Media, Quantity	Marking Information
TP2431	TP2431-SR	8-Pin SOP	Tape and Reel, 4,000	TP2431
	TP2431-TR	5-Pin SOT23	Tape and Reel, 3,000	431
	TP2431U-TR	5-Pin SOT23	Tape and Reel, 3,000	43U
TP2432	TP2432-SR	8-Pin SOP	Tape and Reel, 4,000	TP2432
	TP2432-VR	8-Pin MSOP	Tape and Reel, 3,000	TP2432
TP2434	TP2434-SR	14-Pin SOP	Tape and Reel, 2,500	TP2434
	TP2434-TR	14-Pin TSSOP	Tape and Reel, 3,000	TP2434

### Absolute Maximum Ratings <sup>Note 1</sup>

Supply Voltage: $V^+ - V^-$ <sup>Note 2</sup> .....	7.0V	Current at Supply Pins.....	$\pm 60\text{mA}$
Input Voltage.....	$V^- - 0.3$ to $V^+ + 0.3$	Operating Temperature Range.....	$-40^\circ\text{C}$ to $125^\circ\text{C}$
Input Current: +IN, -IN <sup>Note 3</sup> .....	$\pm 20\text{mA}$	Maximum Junction Temperature.....	$150^\circ\text{C}$
Output Current: OUT.....	$\pm 160\text{mA}$	Storage Temperature Range.....	$-65^\circ\text{C}$ to $150^\circ\text{C}$
Output Short-Circuit Duration <sup>Note 4</sup> .....	Indefinite	Lead Temperature (Soldering, 10 sec).....	$260^\circ\text{C}$

**Note 1:** Stresses beyond those listed under Absolute Maximum Ratings may cause permanent damage to the device. Exposure to any Absolute Maximum Rating condition for extended periods may affect device reliability and lifetime.

**Note 2:** The op amp supplies must be established simultaneously, with, or before, the application of any input signals.

**Note 3:** The inputs are protected by ESD protection diodes to each power supply. If the input extends more than 500mV beyond the power supply, the input current should be limited to less than 10mA.

**Note 4:** A heat sink may be required to keep the junction temperature below the absolute maximum. This depends on the power supply voltage and how many amplifiers are shorted. Thermal resistance varies with the amount of PC board metal connected to the package. The specified values are for short traces connected to the leads.

### ESD, Electrostatic Discharge Protection

Symbol	Parameter	Condition	Minimum Level	Unit
HBM	Human Body Model ESD	MIL-STD-883H Method 3015.8	7	kV
CDM	Charged Device Model ESD	JEDEC-EIA/JESD22-C101E	2	kV

### Thermal Resistance

Package Type	$\theta_{JA}$	$\theta_{JC}$	Unit
5-Pin SOT23	250	81	$^\circ\text{C}/\text{W}$
8-Pin SOP	158	43	$^\circ\text{C}/\text{W}$
8-Pin MSOP	210	45	$^\circ\text{C}/\text{W}$
8-Pin SOT23	196	70	$^\circ\text{C}/\text{W}$
14-Pin SOP	120	36	$^\circ\text{C}/\text{W}$
14-Pin TSSOP	180	35	$^\circ\text{C}/\text{W}$

1.6MHz Bandwidth, Micropower Low Noise Op-amps

**Electrical Characteristics**

The specifications are at  $T_A = 27^\circ\text{C}$ .  $V_S = +2.7\text{ V to }+5.5\text{ V}$ , or  $\pm 1.35\text{ V to } \pm 2.75\text{ V}$ ,  $R_L = 2\text{ k}\Omega$ ,  $C_L = 100\text{ pF}$ . Unless otherwise noted.

SYMBOL	PARAMETER	CONDITIONS	MIN	TYP	MAX	UNITS
$V_{OS}$	Input Offset Voltage	$V_{CM} = V_{DD}/2$	-1	$\pm 0.3$	+1	mV
$V_{OS\ TC}$	Input Offset Voltage Drift	$-40^\circ\text{C to } 125^\circ\text{C}$		1	2	$\mu\text{V}/^\circ\text{C}$
$I_B$	Input Bias Current	$T_A = 27^\circ\text{C}$		0.3	3	pA
		$T_A = 85^\circ\text{C}$		150		pA
		$T_A = 125^\circ\text{C}$		300		pA
$I_{OS}$	Input Offset Current			0.001		pA
$V_n$	Input Voltage Noise	$f = 0.1\text{ Hz to } 10\text{ Hz}$		4.1		$\mu\text{V}_{PP}$
$e_n$	Input Voltage Noise Density	$f = 1\text{ kHz}$		13		$\text{nV}/\sqrt{\text{Hz}}$
$i_n$	Input Current Noise	$f = 1\text{ kHz}$		2		$\text{fA}/\sqrt{\text{Hz}}$
$C_{IN}$	Input Capacitance	Differential		7.76		pF
		Common Mode		6.87		
CMRR	Common Mode Rejection Ratio	$V_{CM} = 2\text{ V to } 3\text{ V}$	85	110		dB
$V_{CM}$	Common-mode Input Voltage Range		$V - 0.1$		$V + 0.1$	V
PSRR	Power Supply Rejection Ratio	$V_{CM} = 2.5\text{ V}$ , $V_S = 4.8\text{ V to } 5\text{ V}$	75	100		dB
$A_{VOL}$	Open-Loop Large Signal Gain	$R_{LOAD} = 2\text{ k}\Omega$	100	130		dB
$V_{OL}$ , $V_{OH}$	Output Swing from Supply Rail	$R_{LOAD} = 2\text{ k}\Omega$		15	45	mV
$R_{OUT}$	Closed-Loop Output Impedance	$G = 1$ , $f = 1\text{ kHz}$ , $I_{OUT} = 0$		0.002		$\Omega$
$R_O$	Open-Loop Output Impedance	$f = 1\text{ kHz}$ , $I_{OUT} = 0$		125		$\Omega$
$I_{SC}$	Output Short-Circuit Current	Sink or source current	95	130		mA
$V_{DD}$	Supply Voltage		2.2		5.5	V
$I_Q$	Quiescent Current per Amplifier			190	280	$\mu\text{A}$
PM	Phase Margin	$R_{LOAD} = 1\text{ k}\Omega$ , $C_{LOAD} = 60\text{ pF}$		80		$^\circ$
GM	Gain Margin	$R_{LOAD} = 1\text{ k}\Omega$ , $C_{LOAD} = 60\text{ pF}$		15		dB
GBWP	Gain-Bandwidth Product	$f = 1\text{ kHz}$		1.6		MHz
SR	Slew Rate	$A_V = 1$ , $V_{OUT} = 1.5\text{ V to } 3.5\text{ V}$ , $C_{LOAD} = 60\text{ pF}$ , $R_{LOAD} = 1\text{ k}\Omega$	0.36	0.84		$\text{V}/\mu\text{s}$
FPBW	Full Power Bandwidth <sup>Note 1</sup>			58.6		kHz
$t_s$	Settling Time, 0.1% Settling Time, 0.01%	$A_V = -1$ , 1V Step		4.4		$\mu\text{s}$
				4.4		
THD+N	Total Harmonic Distortion and Noise	$f = 1\text{ kHz}$ , $A_V = 1$ , $R_L = 2\text{ k}\Omega$ , $V_{OUT} = 1\text{ V}_{p-p}$		0.0003		%
$X_{talk}$	Channel Separation	$f = 1\text{ kHz}$ , $R_L = 2\text{ k}\Omega$		110		dB

**Note 1:** Full power bandwidth is calculated from the slew rate  $FPBW = SR/\pi \cdot V_{P-P}$

**1.6MHz Bandwidth, Micropower Low Noise Op-amps**  
**Typical Performance Characteristics**

$V_S = \pm 2.75V$ ,  $V_{CM} = 0V$ ,  $R_L = \text{Open}$ , unless otherwise specified.

Offset Voltage Production Distribution

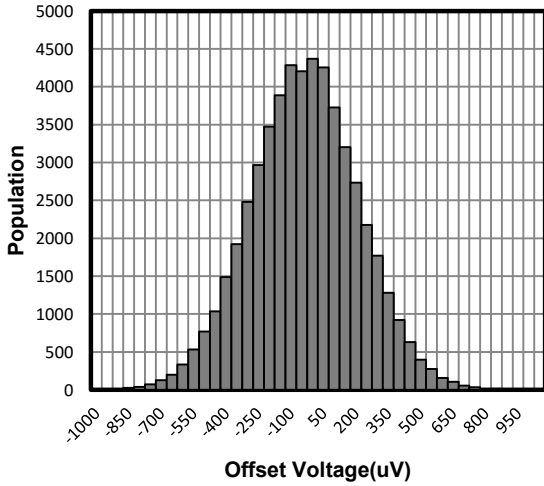

Unity Gain Bandwidth vs. Temperature

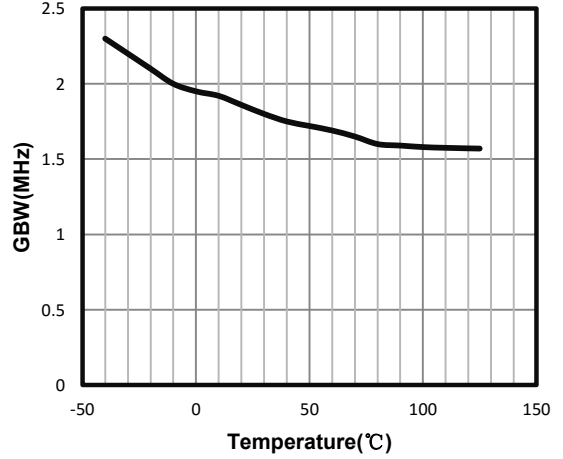

Open-Loop Gain and Phase

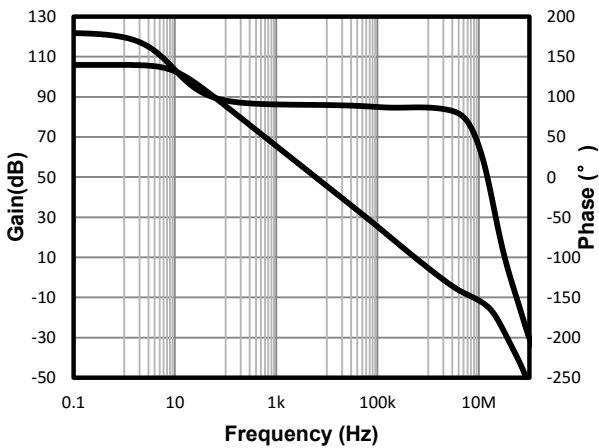

Input Voltage Noise Spectral Density

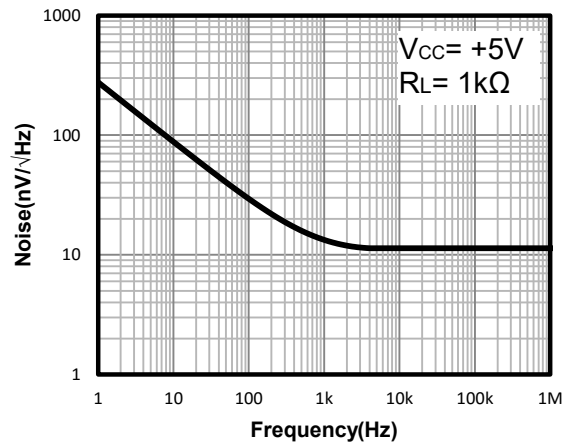

Input Bias Current vs. Temperature

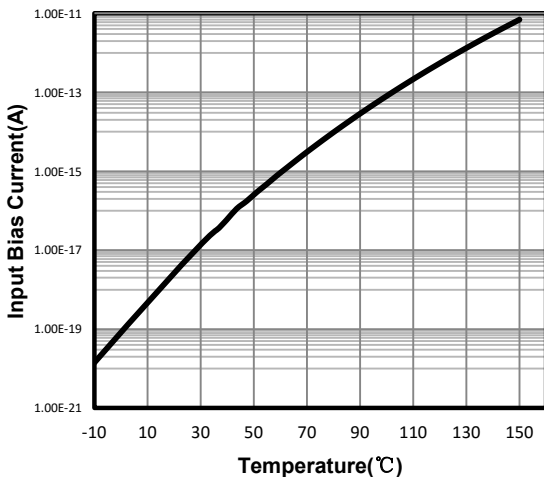

Input Bias Current vs. Input Common Mode Voltage

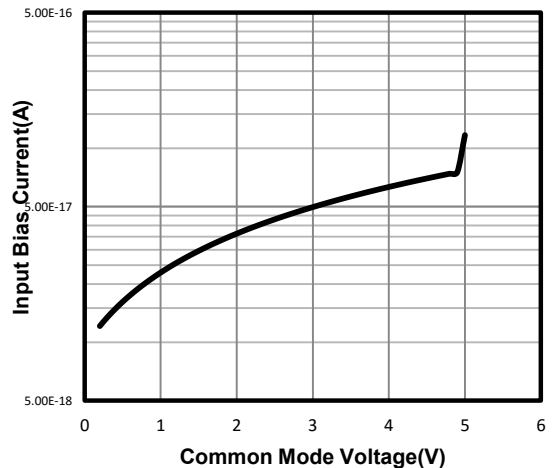

1.6MHz Bandwidth, Micropower Low Noise Op-amps

Typical Performance Characteristics

$V_S = \pm 2.75V$ ,  $V_{CM} = 0V$ ,  $R_L = \text{Open}$ , unless otherwise specified. (Continued)

Common Mode Rejection Ratio

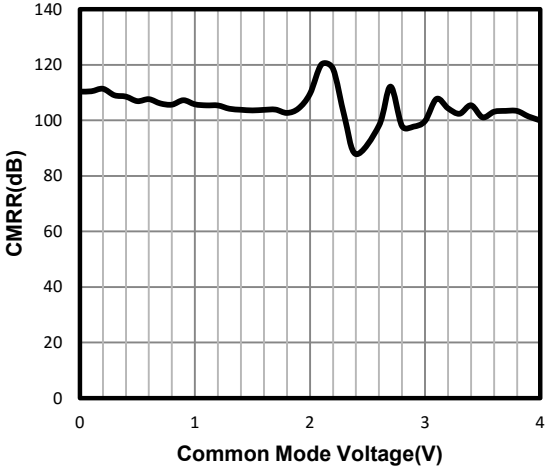

CMRR vs. Frequency

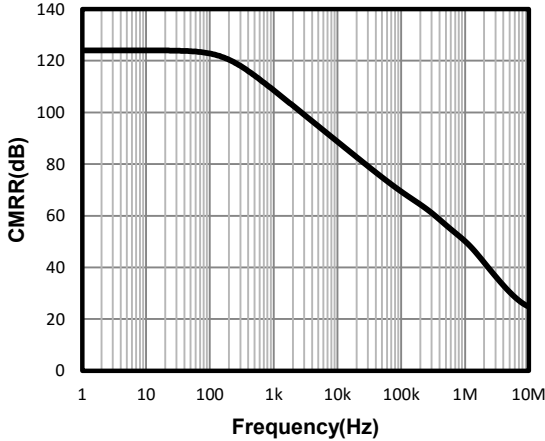

Quiescent Current vs. Temperature

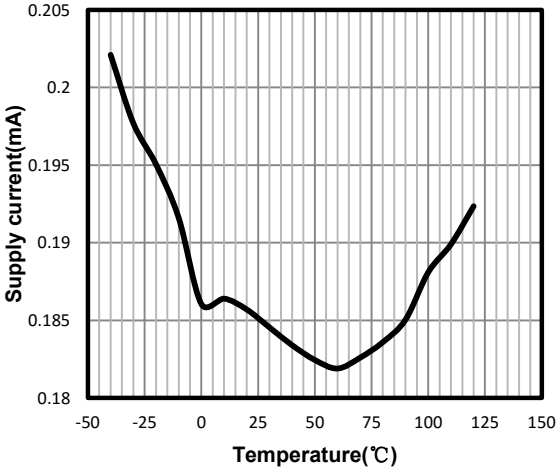

Short Circuit Current vs. Temperature

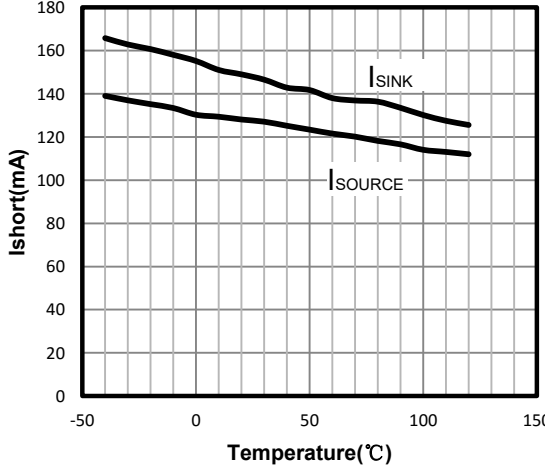

Power-Supply Rejection Ratio

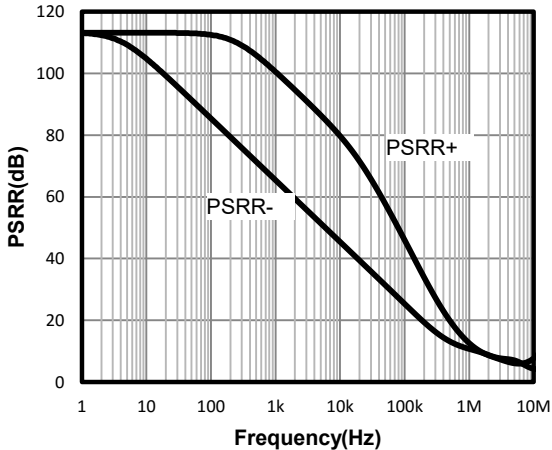

Quiescent Current vs. Supply Voltage

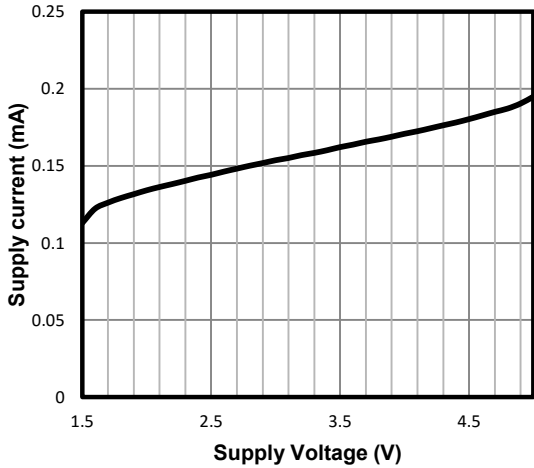

1.6MHz Bandwidth, Micropower Low Noise Op-amps  
**Typical Performance Characteristics**

$V_S = \pm 2.75V$ ,  $V_{CM} = 0V$ ,  $R_L = \text{Open}$ , unless otherwise specified. (Continued)

Power-Supply Rejection Ratio vs. Temperature

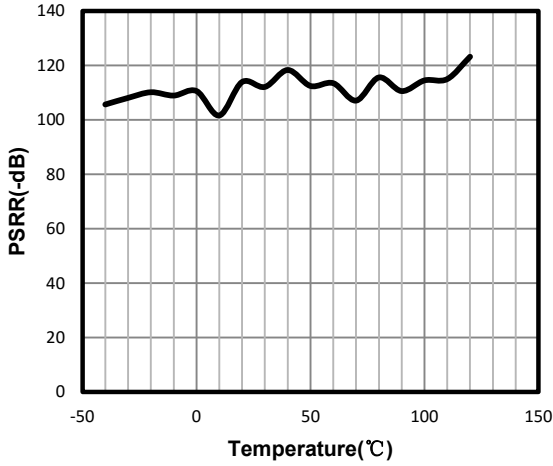

CMRR vs. Temperature

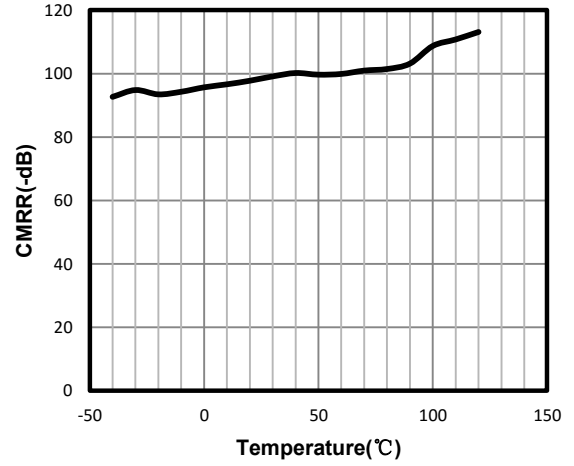

EMIRR IN+ vs. Frequency

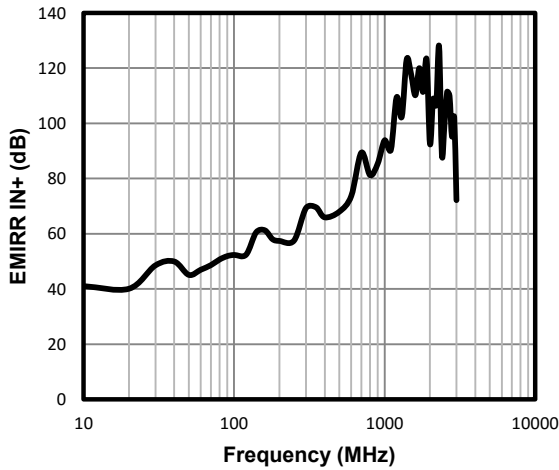

Large-Scale Step Response

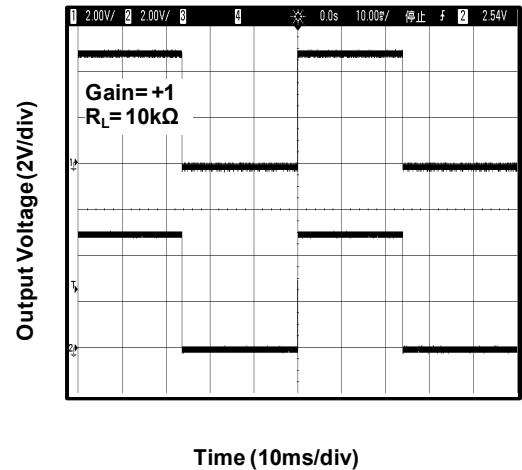

Negative Over-Voltage Recovery

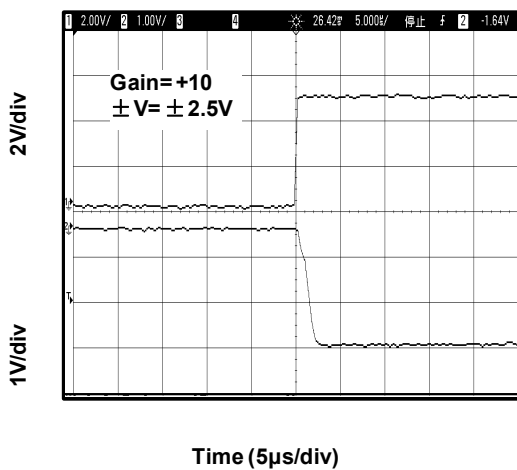

Positive Over-Voltage Recovery

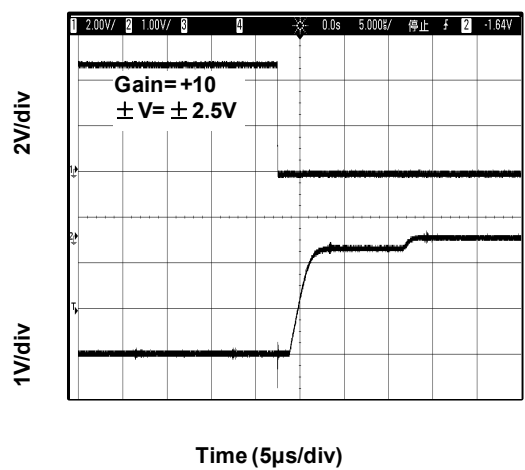

1.6MHz Bandwidth, Micropower Low Noise Op-amps

Typical Performance Characteristics

$V_S = \pm 2.75V$ ,  $V_{CM} = 0V$ ,  $R_L = \text{Open}$ , unless otherwise specified. (Continued)

0.1 Hz TO 10 Hz Input Voltage Noise

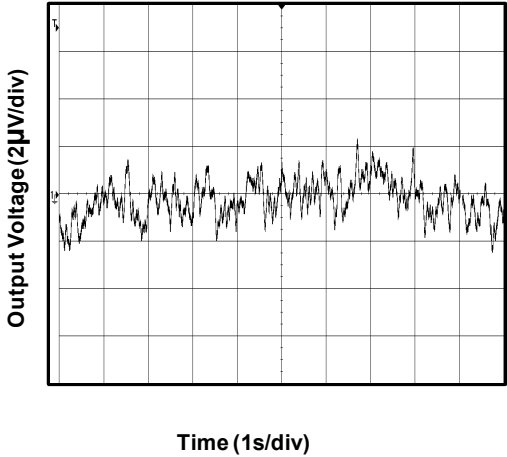

Offset Voltage vs Common-Mode Voltage

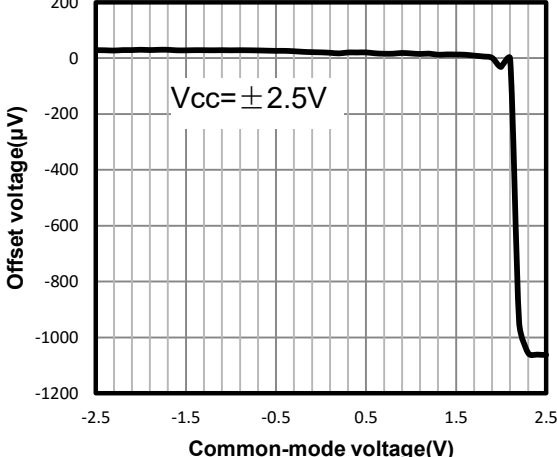

Positive Output Swing vs. Load Current

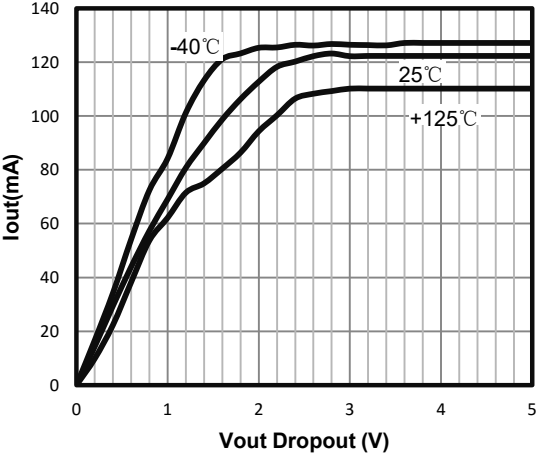

Negative Output Swing vs. Load Current

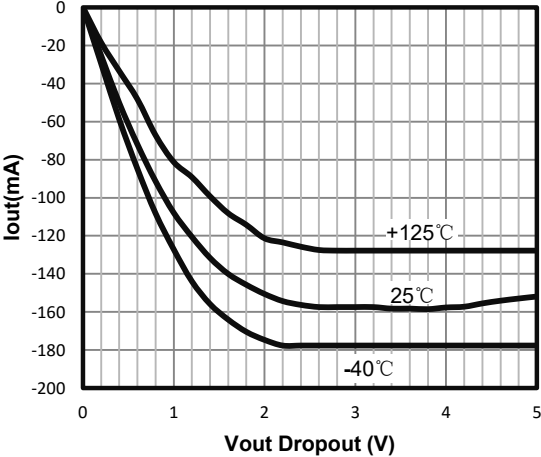

# TP2431 / TP2432 / TP2434

## 1.6MHz Bandwidth, Micropower Low Noise Op-amps

### Pin Functions

**-IN:** Inverting Input of the Amplifier.

**+IN:** Non-Inverting Input of Amplifier.

**OUT:** Amplifier Output. The voltage range extends to within mV of each supply rail.

**V+ or +Vs:** Positive Power Supply. Typically the voltage is from 2.2V to 5.5V. Split supplies are possible as long as the voltage between V+ and V- is between 2.2V and 5.5V. A bypass capacitor of 0.1 $\mu$ F as close to the part as

possible should be used between power supply pins or between supply pins and ground.

**V- or -Vs:** Negative Power Supply. It is normally tied to ground. It can also be tied to a voltage other than ground as long as the voltage between V+ and V- is from 2.2V to 5.5V. If it is not connected to ground, bypass it with a capacitor of 0.1 $\mu$ F as close to the part as possible.

### Operation

The TP2431/TP2432/TP2434 can operate from a single +2.2V to +5.5V power supply, or from  $\pm 1.1$ V to  $\pm 2.75$ V power supplies. The power supply pin(s) must be bypassed to ground with a 0.1 $\mu$ F capacitor as close to the pin as possible. The single TP2431, dual TP2432 and quad TP2434 op amps combine excellent DC accuracy with rail-to-rail operation at both input and output. With their precision performance, wide dynamic range at low supply voltages, and very low supply current, these op amps are ideal for battery-operated equipment, industrial, and data acquisition and control applications.

### Applications Information

#### Rail-to-Rail Inputs and Outputs

The TP243x op amps are designed to be immune to phase reversal when the input pins exceed the supply voltages, therefore providing further in-system stability and predictability. Figure 1 shows the input voltage exceeding the supply voltage without any phase reversal.

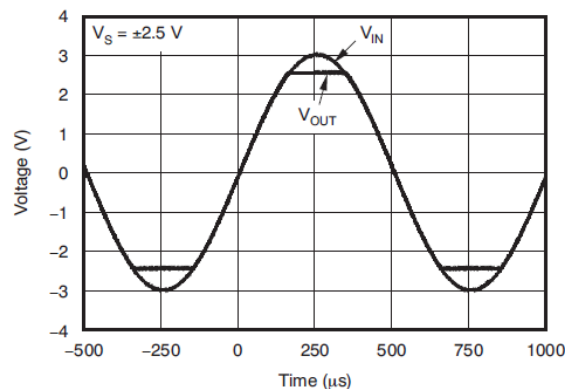

Figure 1. No Phase Reversal

#### Input ESD Diode Protection

The TP2431 incorporates internal electrostatic discharge (ESD) protection circuits on all pins. In the case of input and output pins, this protection primarily consists of current-steering diodes connected between the input and power-supply pins. These ESD protection diodes also provide in-circuit input overdrive protection, as long as the current is limited to 10 mA as stated in the Absolute Maximum Ratings table. Many input signals are inherently current-limited to less than 10 mA; therefore, a limiting resistor is not required. Figure 2 shows how a series input resistor ( $R_S$ ) may be added to the driven input to limit the input current. The added resistor contributes thermal noise at the amplifier input and the



1.6MHz Bandwidth, Micropower Low Noise Op-amps

value should be kept to the minimum in noise-sensitive applications.

Current-limiting resistor required if input voltage exceeds supply rails by >0.5V.

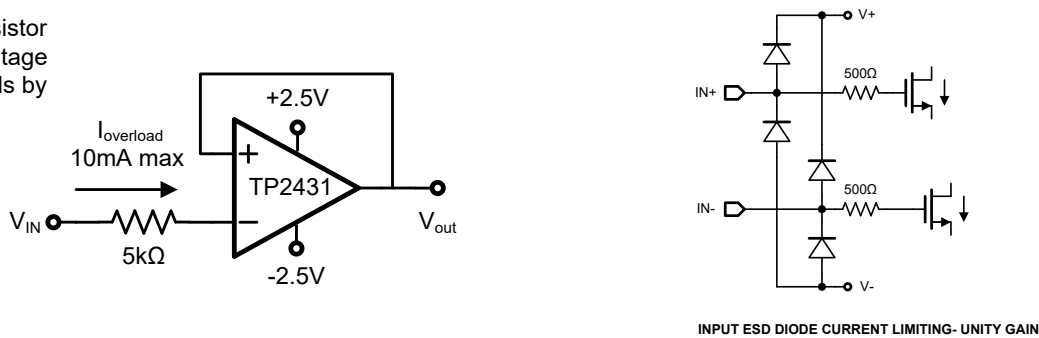

Figure 2. Input ESD Diode

EMI Susceptibility and Input Filtering

Operational amplifiers vary in susceptibility to electromagnetic interference (EMI). If conducted EMI enters the device, the dc offset observed at the amplifier output may shift from the nominal value while EMI is present. This shift is a result of signal rectification associated with the internal semiconductor junctions. While all operational amplifier pin functions can be affected by EMI, the input pins are likely to be the most susceptible. The TP2431 operational amplifier family incorporates an internal input low-pass filter that reduces the amplifier response to EMI. Both common-mode and differential mode filtering are provided by the input filter. The filter is designed for a cutoff frequency of approximately 400 MHz (-3 dB), with a roll-off of 20 dB per decade.

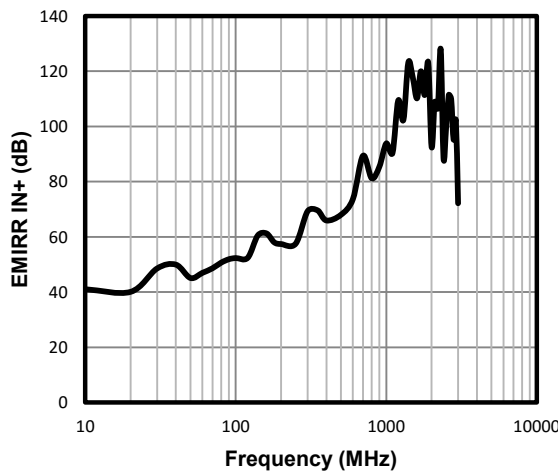

Figure 3. TP2431 EMIRR IN+ vs Frequency

PCB Surface Leakage

In applications where low input bias current is critical, Printed Circuit Board (PCB) surface leakage effects need to be considered. Surface leakage is caused by humidity, dust or other contamination on the board. Under low humidity conditions, a typical resistance between nearby traces is  $10^{12}\Omega$ . A 5V difference would cause 5pA of current to flow, which is greater than the TP2431/2432/2434 OPA's input bias current at +27°C ( $\pm 0.3\text{pA}$ , typical). It is recommended to use multi-layer PCB layout and route the OPA's -IN and +IN signal under the PCB surface.

## 1.6MHz Bandwidth, Micropower Low Noise Op-amps

The effective way to reduce surface leakage is to use a guard ring around sensitive pins (or traces). The guard ring is biased at the same voltage as the sensitive pin. An example of this type of layout is shown in Figure 6 for Inverting Gain application.

### 1. For Non-Inverting Gain and Unity-Gain Buffer:

- a) Connect the non-inverting pin ( $V_{IN+}$ ) to the input with a wire that does not touch the PCB surface.
- b) Connect the guard ring to the inverting input pin ( $V_{IN-}$ ). This biases the guard ring to the Common Mode input voltage.

### 2. For Inverting Gain and Trans-impedance Gain Amplifiers (convert current to voltage, such as photo detectors):

- a) Connect the guard ring to the non-inverting input pin ( $V_{IN+}$ ). This biases the guard ring to the same reference voltage as the op-amp (e.g.,  $V_{DD}/2$  or ground).
- b) Connect the inverting pin ( $V_{IN-}$ ) to the input with a wire that does not touch the PCB surface.

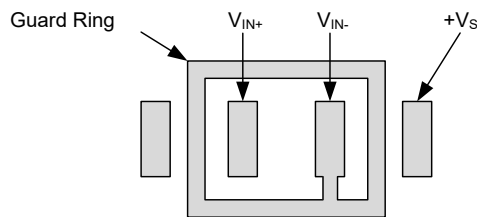

Figure 4 The Layout of Guard Ring

## Power Supply Layout and Bypass

The TP2431/2432/2434 OPA's power supply pin ( $V_{DD}$  for single-supply) should have a local bypass capacitor (i.e.,  $0.01\mu\text{F}$  to  $0.1\mu\text{F}$ ) within 2mm for good high frequency performance. It can also use a bulk capacitor (i.e.,  $1\mu\text{F}$  or larger) within 100mm to provide large, slow currents. This bulk capacitor can be shared with other analog parts.

Ground layout improves performance by decreasing the amount of stray capacitance and noise at the OPA's inputs and outputs. To decrease stray capacitance, minimize PCB board lengths and resistor leads, and place external components as close to the op amps' pins as possible.

## Proper Board Layout

To ensure optimum performance at the PCB level, care must be taken in the design of the board layout. To avoid leakage currents, the surface of the board should be kept clean and free of moisture. Coating the surface creates a barrier to moisture accumulation and helps reduce parasitic resistance on the board.

Keeping supply traces short and properly bypassing the power supplies minimizes power supply disturbances due to output current variation, such as when driving an ac signal into a heavy load. Bypass capacitors should be connected as closely as possible to the device supply pins. Stray capacitances are a concern at the outputs and the inputs of the amplifier. It is recommended that signal traces be kept at least 5mm from supply lines to minimize coupling.

A variation in temperature across the PCB can cause a mismatch in the Seebeck voltages at solder joints and other points where dissimilar metals are in contact, resulting in thermal voltage errors. To minimize these thermocouple effects, orient resistors so heat sources warm both ends equally. Input signal paths should contain matching numbers and types of components, where possible to match the number and type of thermocouple junctions. For example, dummy components such as zero value resistors can be used to match real resistors in the opposite input path. Matching components should be located in close proximity and should be oriented in the same manner. Ensure leads are of equal length so that thermal conduction is in equilibrium. Keep heat sources on the PCB as far away from amplifier input circuitry as is practical.

The use of a ground plane is highly recommended. A ground plane reduces EMI noise and also helps to maintain a constant temperature across the circuit board.

1.6MHz Bandwidth, Micropower Low Noise Op-amps

Package Outline Dimensions

SOT23-5

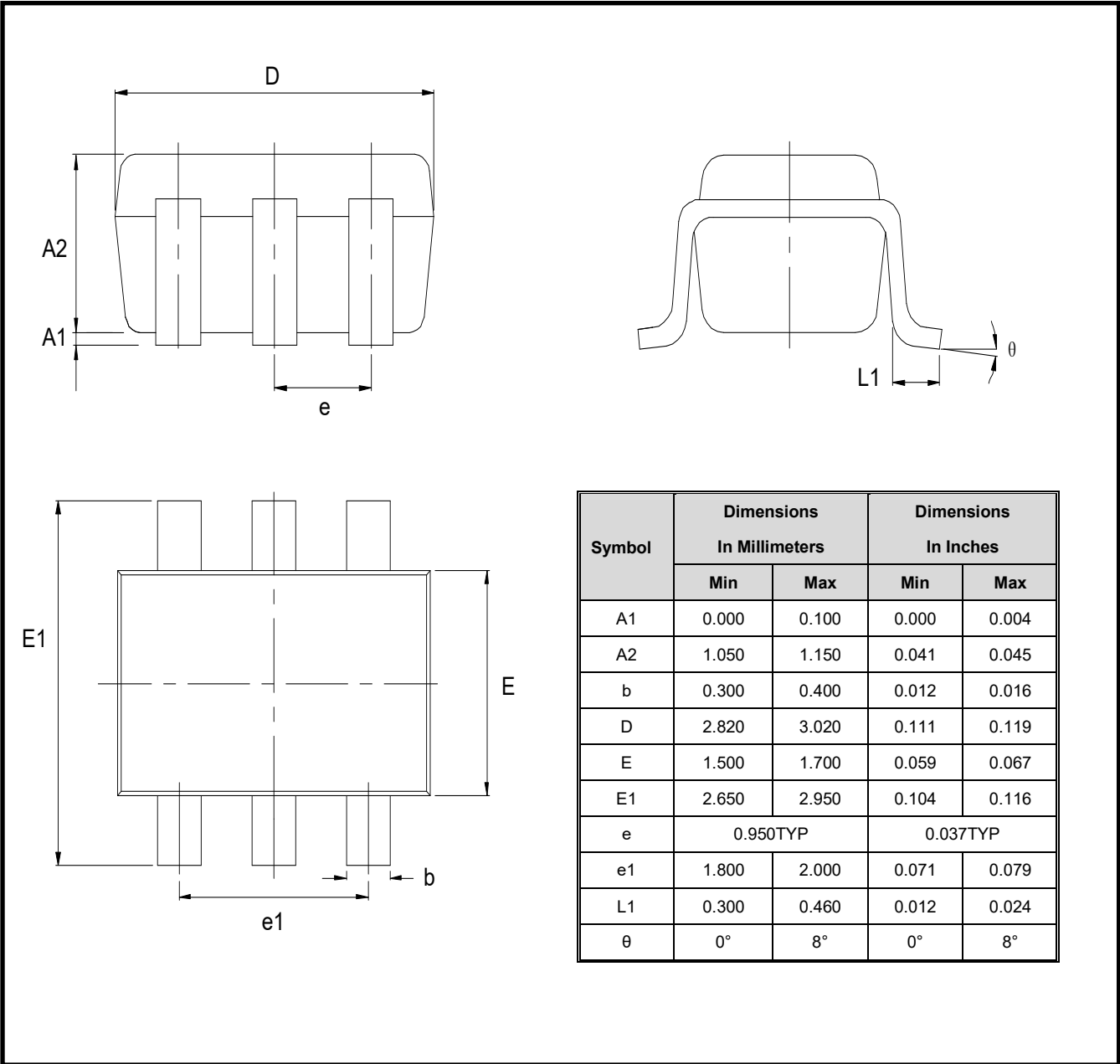

Symbol	Dimensions In Millimeters		Dimensions In Inches	
	Min	Max	Min	Max
A1	0.000	0.100	0.000	0.004
A2	1.050	1.150	0.041	0.045
b	0.300	0.400	0.012	0.016
D	2.820	3.020	0.111	0.119
E	1.500	1.700	0.059	0.067
E1	2.650	2.950	0.104	0.116
e	0.950TYP		0.037TYP	
e1	1.800	2.000	0.071	0.079
L1	0.300	0.460	0.012	0.024
theta	0°	8°	0°	8°

# TP2431 / TP2432 / TP2434

## 1.6MHz Bandwidth, Micropower Low Noise Op-amps

### Package Outline Dimensions

SOT-23-8

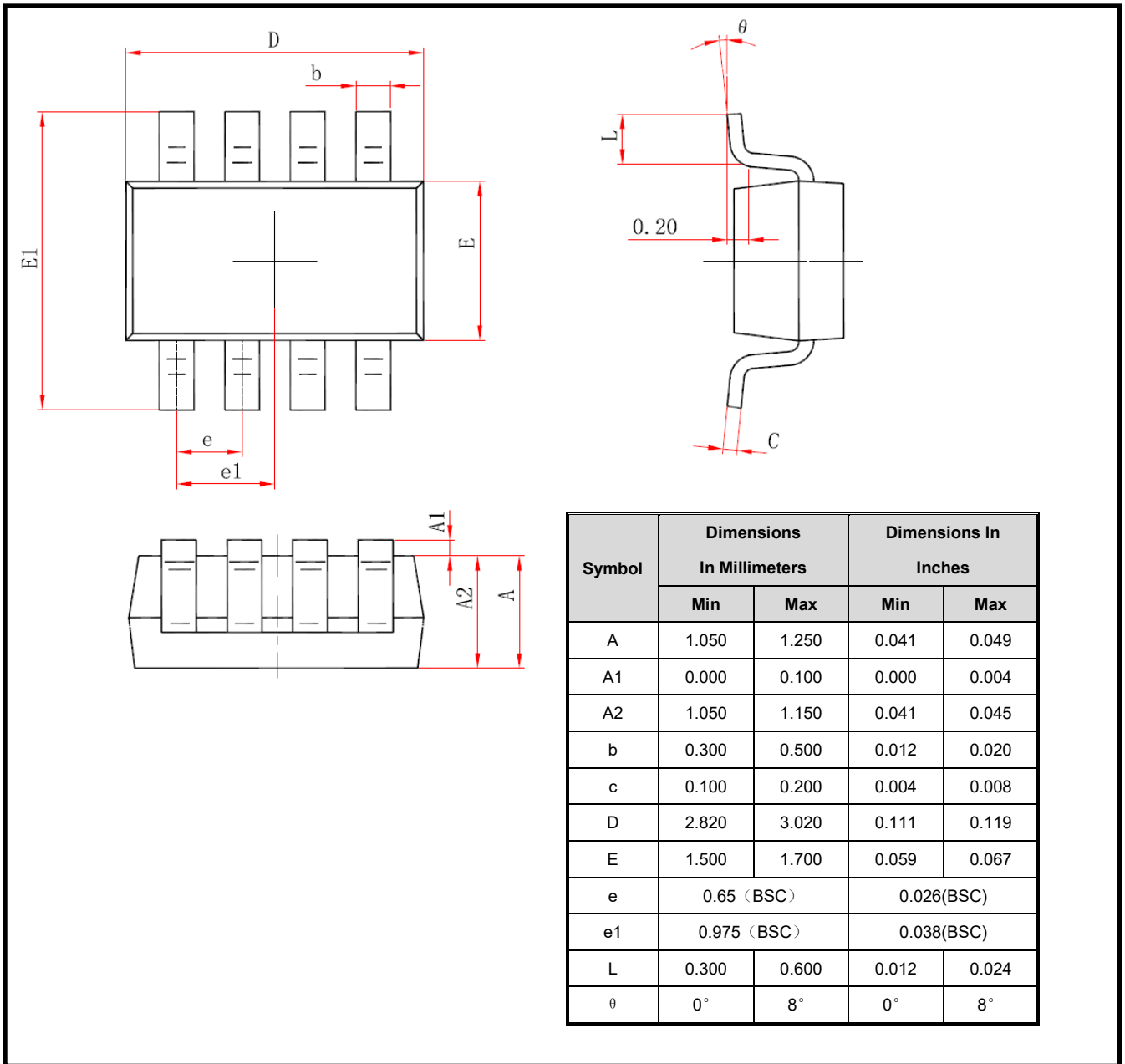

1.6MHz Bandwidth, Micropower Low Noise Op-amps

Package Outline Dimensions

SOP-8

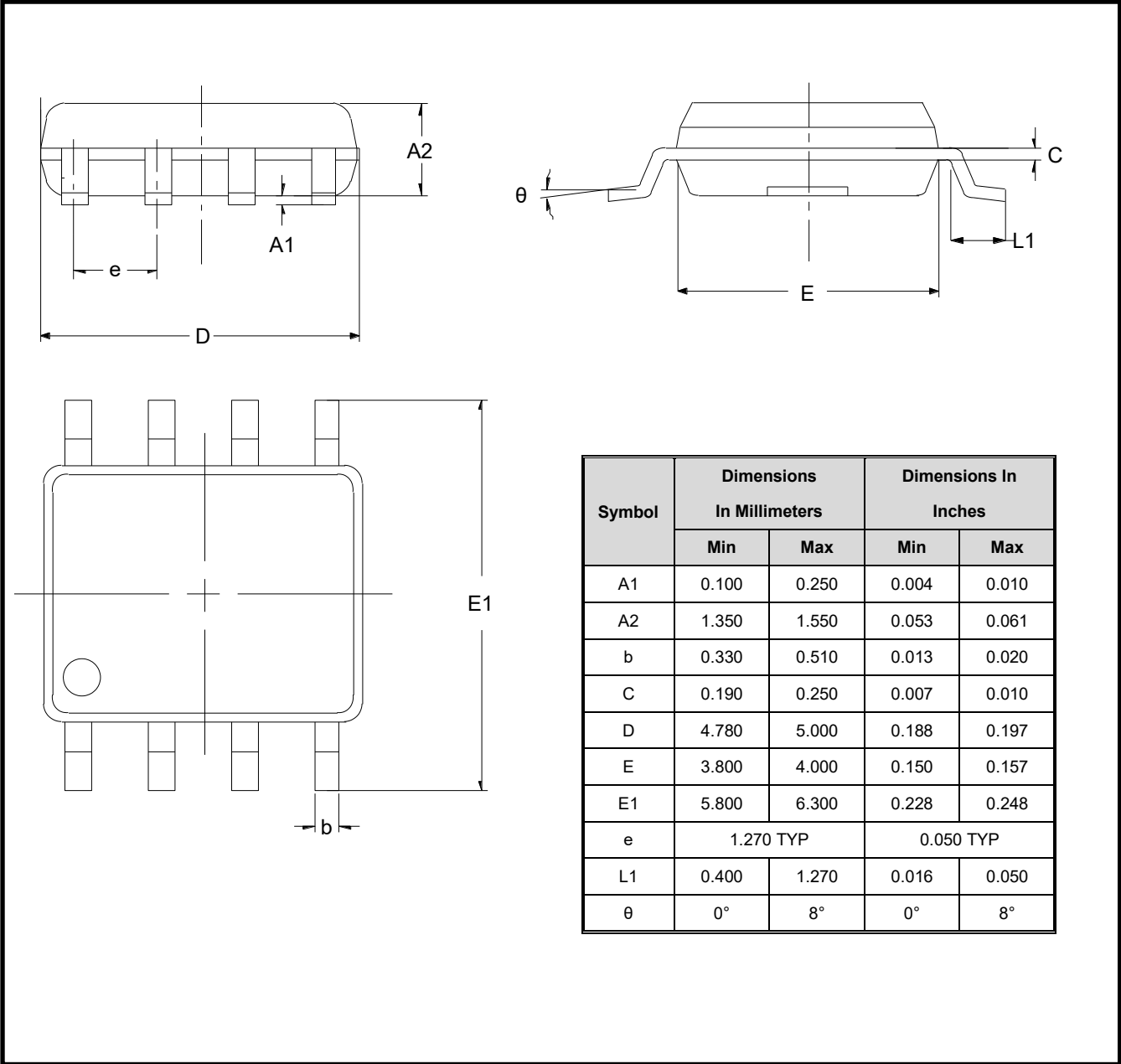

Symbol	Dimensions In Millimeters		Dimensions In Inches	
	Min	Max	Min	Max
A1	0.100	0.250	0.004	0.010
A2	1.350	1.550	0.053	0.061
b	0.330	0.510	0.013	0.020
C	0.190	0.250	0.007	0.010
D	4.780	5.000	0.188	0.197
E	3.800	4.000	0.150	0.157
E1	5.800	6.300	0.228	0.248
e	1.270 TYP		0.050 TYP	
L1	0.400	1.270	0.016	0.050
theta	0°	8°	0°	8°

# TP2431 / TP2432 / TP2434

## 1.6MHz Bandwidth, Micropower Low Noise Op-amps

### Package Outline Dimensions

MSOP-8

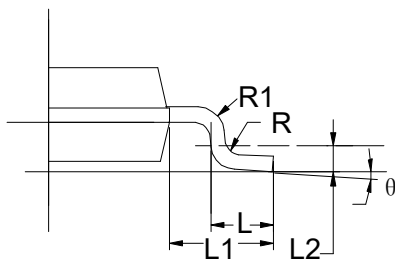
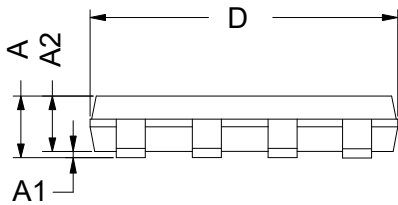
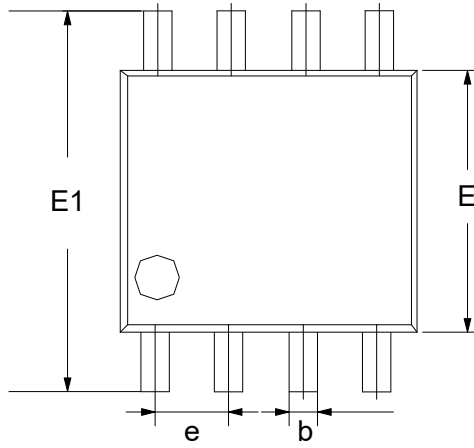

Symbol	Dimensions In Millimeters		Dimensions In Inches	
	Min	Max	Min	Max
A	0.800	1.200	0.031	0.047
A1	0.000	0.200	0.000	0.008
A2	0.760	0.970	0.030	0.038
b	0.30 TYP		0.012 TYP	
C	0.15 TYP		0.006 TYP	
D	2.900	3.100	0.114	0.122
e	0.65 TYP		0.026	
E	2.900	3.100	0.114	0.122
E1	4.700	5.100	0.185	0.201
L1	0.410	0.650	0.016	0.026
θ	0°	6°	0°	6°

1.6MHz Bandwidth, Micropower Low Noise Op-amps

Package Outline Dimensions

TSSOP-14

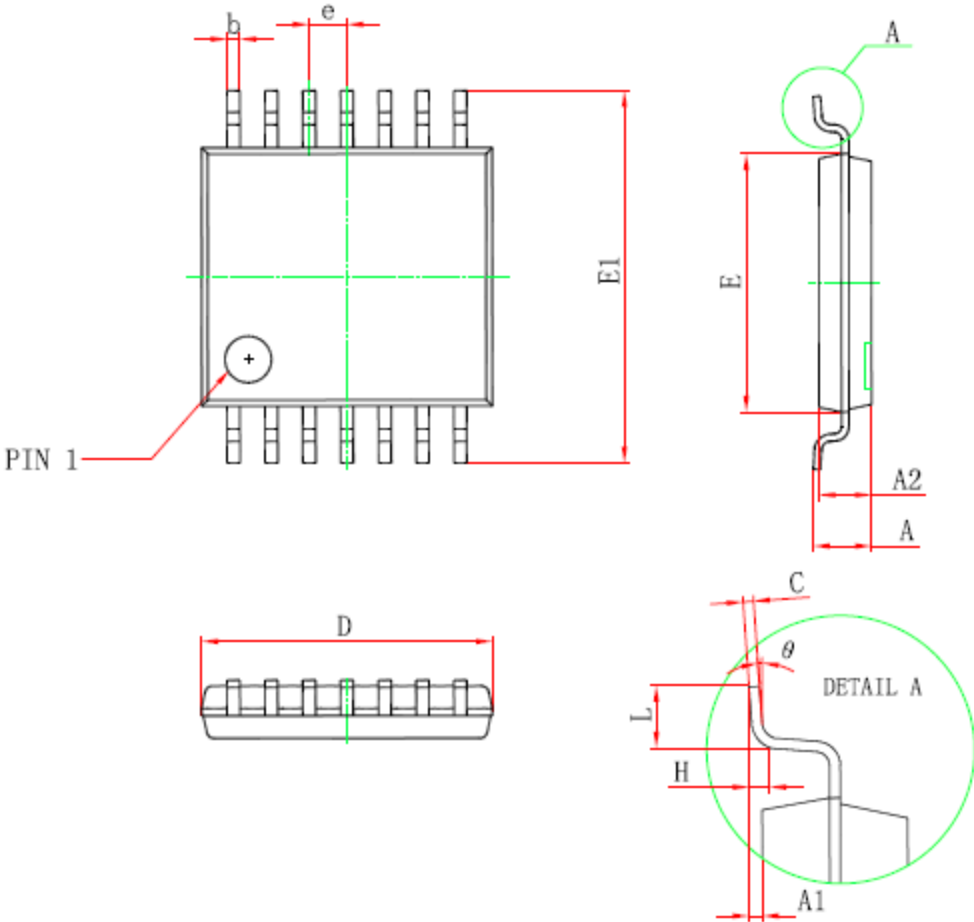

Symbol	Dimensions In Millimeters		
	MIN	TYP	MAX
A	-	-	1.20
A1	0.05	-	0.15
A2	0.80	0.90	1.05
b	0.19	-	0.30
C	0.09	-	0.20
D	4.86	4.96	5.10
E	4.30	4.40	4.50
E1	6.20	6.40	6.60
e	0.65 BSC		
L	0.45	0.60	0.75
H	0.25 BSC		
theta	0°	-	8°

# TP2431 / TP2432 / TP2434

## 1.6MHz Bandwidth, Micropower Low Noise Op-amps

### Package Outline Dimensions

SOP-14

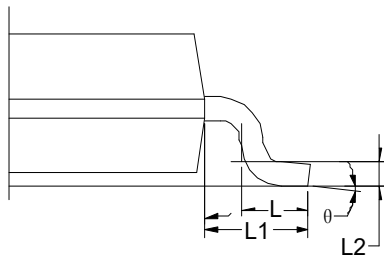
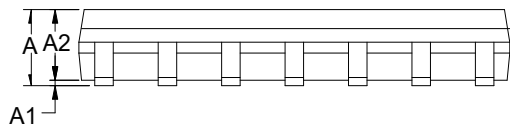
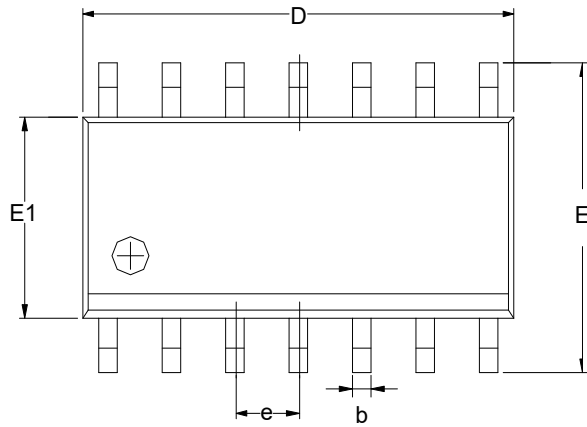

Symbol	Dimensions In Millimeters		
	MIN	TYP	MAX
A	1.35	1.60	1.75
A1	0.10	0.15	0.25
A2	1.25	1.45	1.65
b	0.36		0.49
D	8.53	8.63	8.73
E	5.80	6.00	6.20
E1	3.80	3.90	4.00
e	1.27 BSC		
L	0.45	0.60	0.80
L1	1.04 REF		
L2	0.25 BSC		
$\theta$	0°		8°