

描述/Description

- XNM50550AT/ATS基于快恢复MOSFET技术，为小功率电机驱动应用（如风扇和水泵）提供紧凑型逆变解决方案。
XNM50550AT/ATS is an Advanced IPM Based on Fast-Recovery MOSFET Technology as a Compact Inverter Solution for Small Power Motor Drive Applications Such as Fans and Pumps.
- XNM50550AT/ATS由6个MOSFET、3个HVIC、3个自举二极管和1个NTC组成，紧凑高绝缘并具有优化的热性能。
XNM50550AT/ATS Contains Six MOSFETs, Three Half-Bridge Gate Drive HVICs, Three Bootstrap Diodes and a NTC in a Compact Package Fully Isolated and Optimized for Thermal Performance.
- XNM50550AT/ATS通过优化开关速度和减小寄生电感实现低电磁干扰（EMI）特性。
XNM50550AT/ATS Features Low Electromagnetic Interference (EMI) Characteristics Through Optimizing Switching Speed and Reducing Parasitic Inductance.
- XNM50550AT/ATS使用MOSFET比使用IGBT更坚固耐用，具有更大的安全操作区（SOA）。
Since XNM50550AT/ATS Employs MOSFETs as Power Switches, It Provides Much More Ruggedness and Larger Safe Operating Area (SOA) than IGBT-Based Power Modules.
- XNM50550AT/ATS内置于电机的应用和要求紧凑安装の場合。
XNM50550AT/ATS is the Right Solution for Compact and Reliable Inverter Designs Where the Assembly Space is Constrained.

主要特点

- 内置6个500V/1.2Ω MOSFET和3个半桥栅极驱动（HVIC）
- 3个独立的MOSFET源极副直流端用于变频器电流检测的应用
- HVIC实现驱动和欠压保护功能
- 完全兼容3.3V和5V的MCU接口，高电平有效
- 优化并采用了低电磁干扰设计
- 绝缘级别1500V_{rms}/1min
- 内置负温度系数的电阻用于温度检测
- 封装内置自举二极管
- 符合ROHS

应用

- 小功率电机

Features

- 500 V $R_{DS(on)} = 1.2\Omega$ MOSFET 3-Phase Inverter Including HVICs
- Three Separate Open-Source Pins from Low Side MOSFETs for Three Leg Current Sensing
- HVIC for Gate Driving and Undervoltage Protection
- Active-High Interface, Can Work With 3.3 V / 5 V Logic
- Optimized for Low Electromagnetic Interference
- Isolation Voltage Rating of 1500 V_{rms} for 1 min.
- Temperature feedback via NTC
- Embedded Bootstrap Diode in the Package
- ROHS Compliant

Applications

- Small Power AC Motor

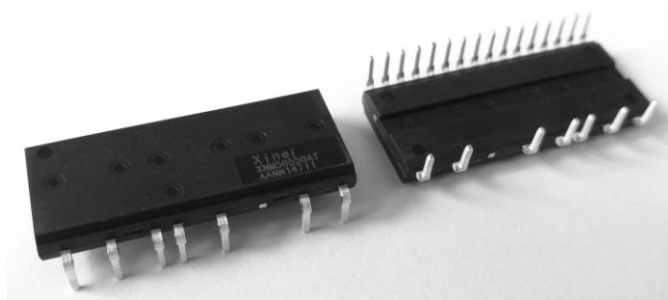

IPM-DIP23

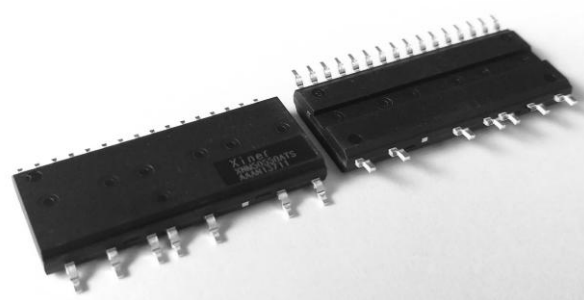

IPM-SOP23

引脚描述 / Pin descriptions

引脚号/Pin Number	引脚名/Pin Name	引脚描述/ Pin Description
1	COM	IC公共电源接地 IC Common Supply Ground
2	$V_{B(U)}$	U相高端MOSFET驱动的偏压 Bias Voltage for U Phase High Side MOSFET Driving
3	$V_{CC(U)}$	U相IC和低端MOSFET驱动的偏压 Bias Voltage for U Phase IC and Low Side MOSFET Driving
4	$IN_{(UH)}$	U相高端的信号输入 Signal Input for U Phase High-Side
5	$IN_{(UL)}$	U相低端的信号输入 Signal Input for U Phase Low-Side
6	N.C	无连接 N.C
7	$V_{B(V)}$	V相高端MOSFET驱动的偏压 Bias Voltage for V Phase High Side MOSFET Driving
8	$V_{CC(V)}$	V相IC和低端MOSFET驱动的偏压 Bias Voltage for V Phase IC and Low Side MOSFET Driving
9	$IN_{(VH)}$	V相高端的信号输入 Signal Input for V Phase High-Side
10	$IN_{(VL)}$	V相低端的信号输入 Signal Input for V Phase Low-Side
11	V_{TH}	热敏电阻电压 NTC Voltage
12	$V_{B(W)}$	W相高端MOSFET驱动的偏压 Bias Voltage for W Phase High Side MOSFET Driving
13	$V_{CC(W)}$	W相IC和低端MOSFET驱动的偏压 Bias Voltage for W Phase IC and Low Side MOSFET Driving
14	$IN_{(WH)}$	W相高端的信号输入 Signal Input for W Phase High-Side
15	$IN_{(WL)}$	W相低端的信号输入 Signal Input for W Phase Low-Side
16	N.C	无连接 N.C
17	P	直流输入正端 Positive DC-Link Input
18	U, $V_{S(U)}$	高端MOSFET驱动的U相偏压接地输出 Output for U Phase & Bias Voltage Ground for High Side MOSFET Driving
19	N_U	U相的直流输入负端 Negative DC-Link Input for U Phase
20	N_V	V相的直流输入负端 Negative DC-Link Input for V Phase
21	V, $V_{S(V)}$	高端MOSFET驱动的V相偏压接地输出 Output for V Phase & Bias Voltage Ground for High Side MOSFET Driving
22	N_W	W相的直流输入负端 Negative DC-Link Input for W Phase
23	W, $V_{S(W)}$	高端MOSFET驱动的W相偏压接地输出 Output for W Phase & Bias Voltage Ground for High Side MOSFET Driving

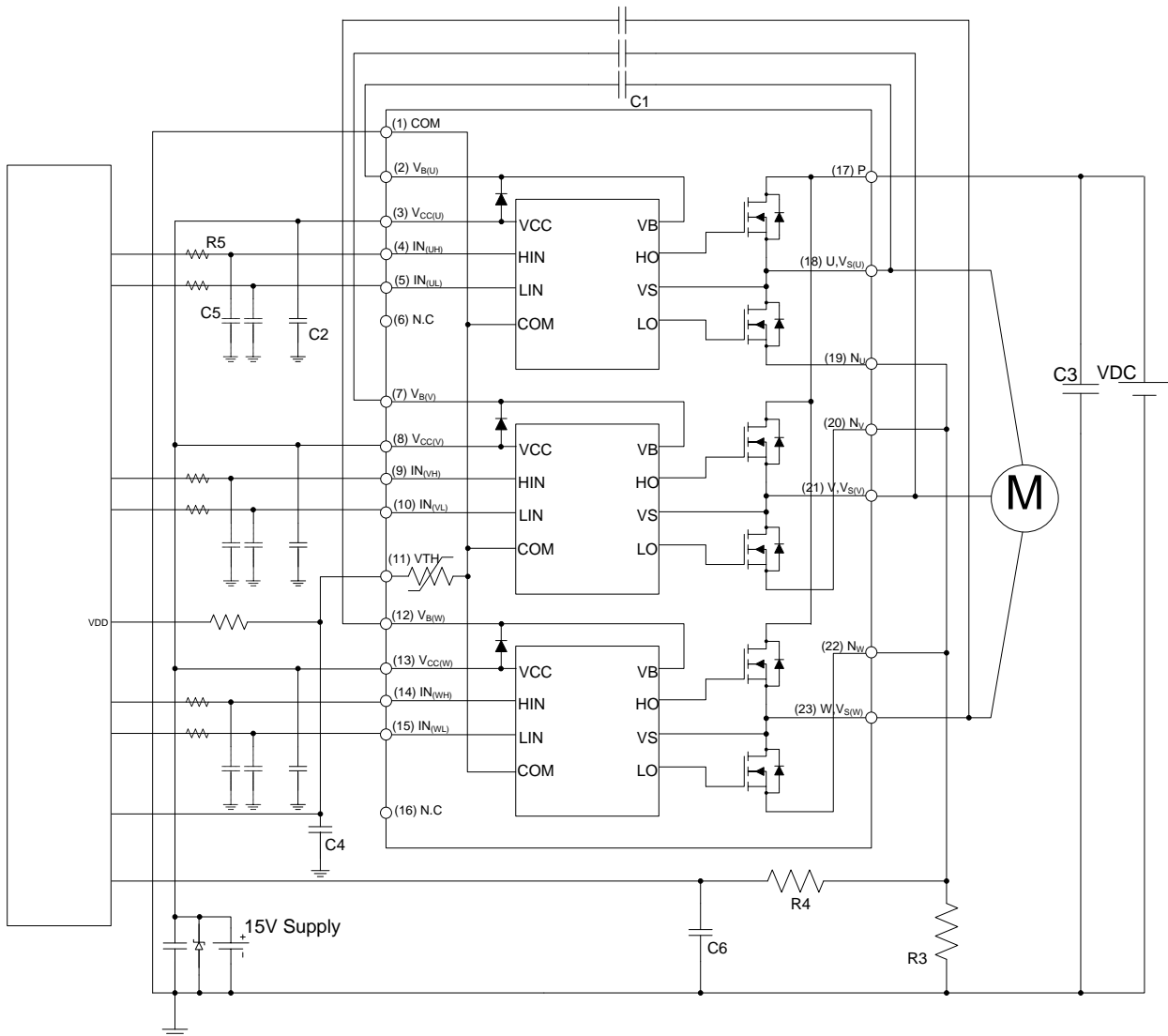

应用电路实例

. Example of Application Circuit

注/Note:

- 关于引脚的位置请参阅图1。
About Pin Position, Refer to Figure 1.
- IPM产品和MCU的每个输入端的RC耦合 (R₅和C₅, R₄和C₆) 和C₄, 能有效地防止由浪涌噪声产生的错误的输入信号。
RC Coupling (R₅ and C₅, R₄ and C₆) and C₄ at Each Input of IPM Mcu are Useful to Prevent Improper Input Signal Caused by Surge Noise.
- 由于位于COM和低端MOSFET的源极端子之间, R₃的压降会影响低端的开关性能和自举特性。为此稳态情况下的R₃的压降应小于1V。
The voltage Drop Across R₃ Affects the Low Side Switching Performance and the Bootstrap Characteristics Since it is Placed Between COM and the Source Terminal of the Low Side MOSFET. For this Reason, the Voltage Drop Across R₃ Should Be Less Than 1 V in the Steady-State.
- 为避免浪涌电压和HVIC故障, 接地线和输出端子之间的接线应短且粗。
Ground Wires and Output Terminals, Should Be Thick and Short in Order to Avoid Surge Voltage and Malfunction of HVIC.
- 所有的滤波电容器应紧密连接到IPM产品, 他们应当具有能够很好的阻挡高频纹波电流的特性。
All the Filter Capacitors Should Be Connected Close to Motion SPM, and They Should Have Good Characteristics for Rejecting High-Frequency Ripple Current.

轮廓封装详图 / Detailed Package Outline Drawings

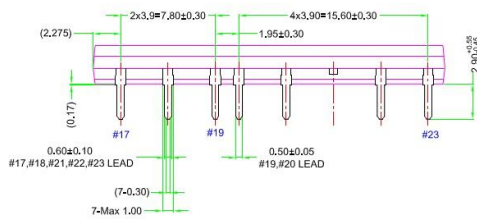
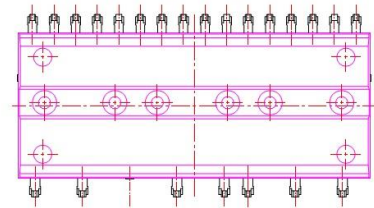
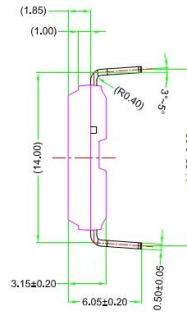
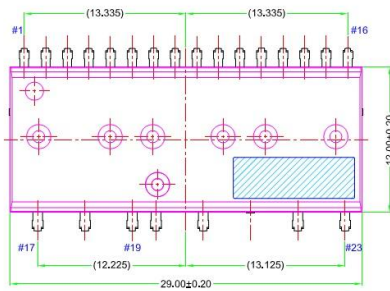
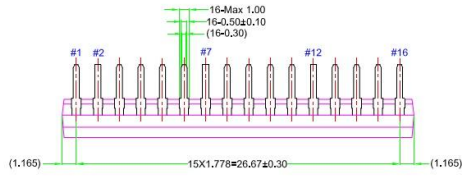

Note:

1. All Dimension Are In mm.
2. The Top Of Pin #2&12 Shape Is Flat.

IPM-DIP23

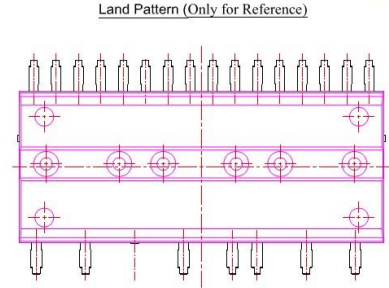
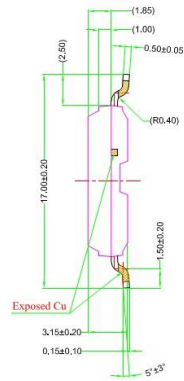
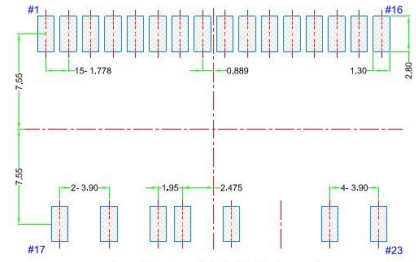
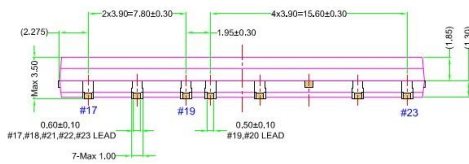
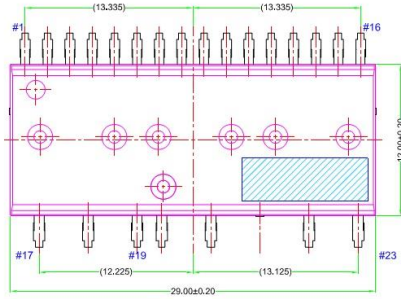
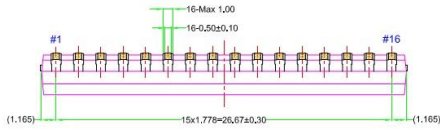

Note:

1. All dimension are in mm.
2. Dimensions are exclusive of burrs, mold flash, and tie bar extrusions.
3. ■ is Exposed Cu.

IPM-SOP23