

HSX321S SPECIFICATION

INDEX

ITEM	PAGE
1. QUARTZ CRYSTAL UNIT SPECIFICATION	3
2. MARKING & DIMENSIONS	4
3. INSIDE STRUCTURE	5
4. EMBOSS CARRIER TAPE&REEL	
a. DIMENSIONS OF CARRIER TAPE	6
b. DIMENSIONS OF REEL	6-7
c. STORAGE CONDITION	7
d. STANDARD PACKING QUANTITY	7
e. MATERIAL OF TAPE	7
f. LABEL CONTENTS	7
g. TAPING DIMENSION	8
h. JOINT OF TAPE	8
i. RELEASE STRENGTH OF COVER TAPE	8
j. PACKAGE	9
5. MECHANICAL PERFORMANCE	10
6. ENVIRONMENTAL PERFORMANCE	11
7. SUPPLEMENT	12-13
8. FLOW CHART	14
9. Environmental Workload Chemical Substance Components List .	15
10. TEST DATA	

Title HSX321S QUARTZ CRYSTAL SPECIFICATION				Country of origin TAIWAN FACTORY THAILAND FACTORY CHINA FACTORY		
Date	Confirm	Check	Prepare	Spec. No.	Rev.	Page
2013/06/07	F. S. TSAI	Y. W. LEE	U. F. CHEN	X3S030000BA1H-U	0	2

1. QUARTZ CRYSTAL UNIT SPECIFICATION

1. Frequency:	30.000000MHz
2. Holder type :	HSX321S
3. Frequency tolerance:	+/-10 ppm at 25deg.C +/-3deg.C
4. Equivalent resistance:	50 ohms Max. / SERIES
5. Storage temperature range:	-40 deg.C To +85 deg.C
6. Operable temperature range:	-20 deg.C To +70 deg.C
7. Temperature drift:	+/-10ppm -20 deg.C To +70 deg.C
8. Loading capacitance (CL) :	10.0 pF
9. Drive level:	10 μ W (100uW Max)
10. Shunt Capacitance:	2.0 pF Max
11. Insulation resistance :	More than 500M ohms at DC 100V
12. Mode of oscillation:	Fundamental
13. Circuit:	Measured in HP/E5100A,S&A 250B
14. Shocking :	Dropping from 75 cm height 3 times on firm wood
Variation :	Frequency less than +/-5 ppm Resistance less than +/- 15 % or 2ohms max.
15. Aging:	Less than +/-3 ppm/Year
16. Holder	HSX321S Seam type
17. Dimensions and marking	Refer to page.4
18. Emboss carrier tape & reel	Refer to page.6 and page.7
19. Moisture Sensitivity Level	Level 1
20. Note:	

Title HSX321S QUARTZ CRYSTAL SPECIFICATION				Country of origin TAIWAN FACTORY THAILAND FACTORY CHINA FACTORY		
Date	Confirm	Check	Prepare	Spec. No.	Rev.	Page
2013/06/07	F. S. TSAI	Y. W. LEE	U. F. CHEN	X3S030000BA1H-U	0	3

3. INSIDE STRUCTURE

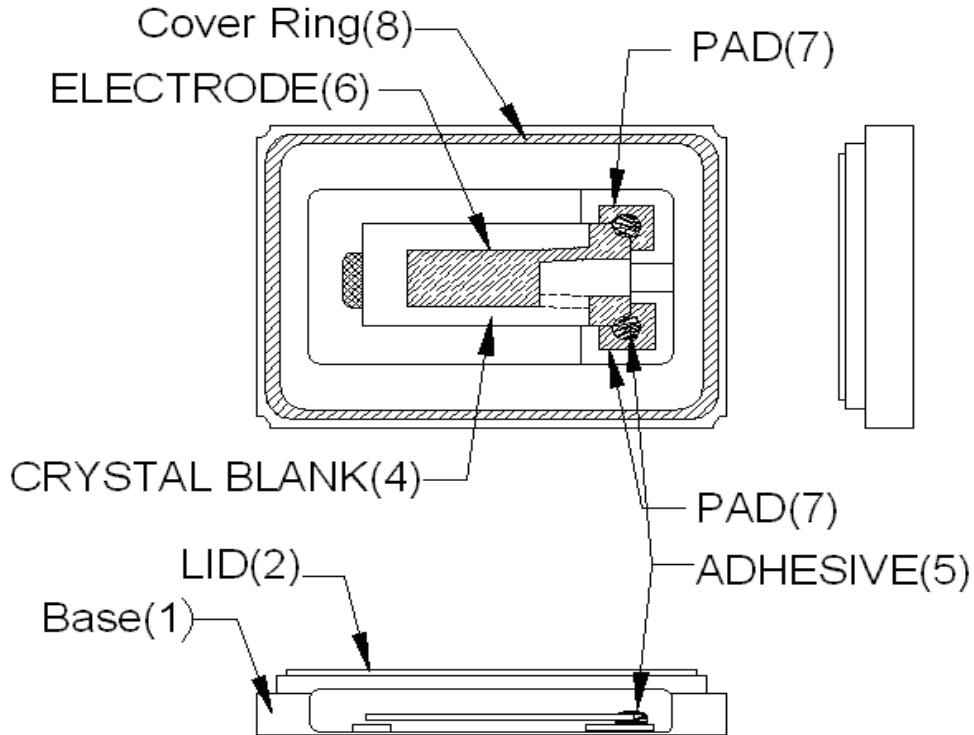

※Reference drawing

1) Base: Alumina Ceramic (Al_2O_3) Metallized Pad: W Ni Plating Au Plating
(2) Lid : Fe- Ni -Co
(3) Crystal Enclosure Seal: Seal Seam
(4) Crystal Blank Rectangular At-Cut Quartz Crystal Blank
(5) Adhesive Silver Conductive Silicon Resin Adhesive bonding: upper & lower bonding/lower bonding only
(6) Electrode
(7) PAD Alumina Ceramic : W Ni Plating Au Plating
(8) Cover Ring : Fe-Ni-Co Alloy

The use prohibition chemistry substance of Table 1 of DHE-0204-1 (HE-QA-24) is not included in this item.

Title HSX321S QUARTZ CRYSTAL SPECIFICATION				Country of origin TAIWAN FACTORY THAILAND FACTORY CHINA FACTORY		
Date	Confirm	Check	Prepare	Spec. No.	Rev.	Page
2013/06/07	F. S. TSAI	Y. W. LEE	U. F. CHEN	X3S030000BA1H-U	0	5

4. HSX321S EMBOSS CARRIER TAPE & REEL

a.) Dimensions of Carrier Tape

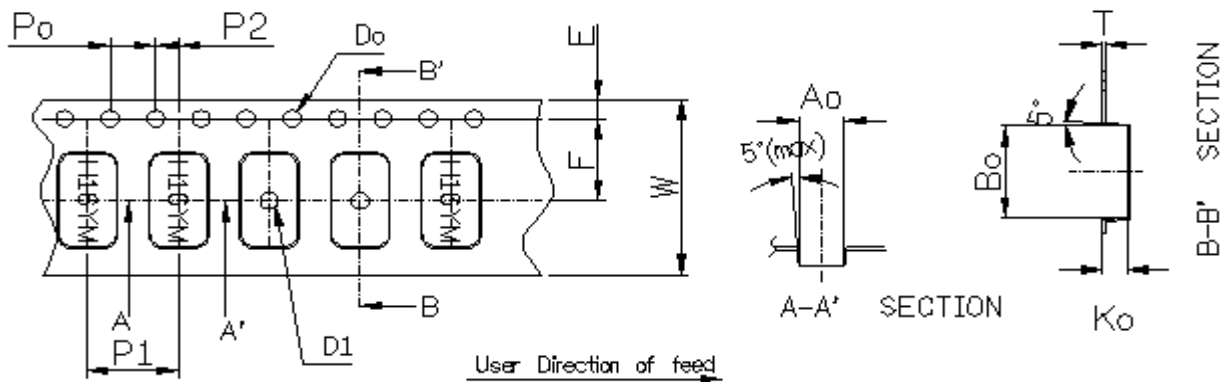

Symbol	Ao	Bo	Ko	Po	P1	P2
Spec	2.70±0.1	3.4±0.1	1.40±0.1	4.0±0.1	4.0±0.1	2.0±0.05
Symbol	E	F	Do	D1	W	T
Spec	1.75±0.1	3.5±0.05	∅1.55±0.05	∅1.0(min)	8.0±0.2	0.25±0.05

b.) Dimensions of Reel

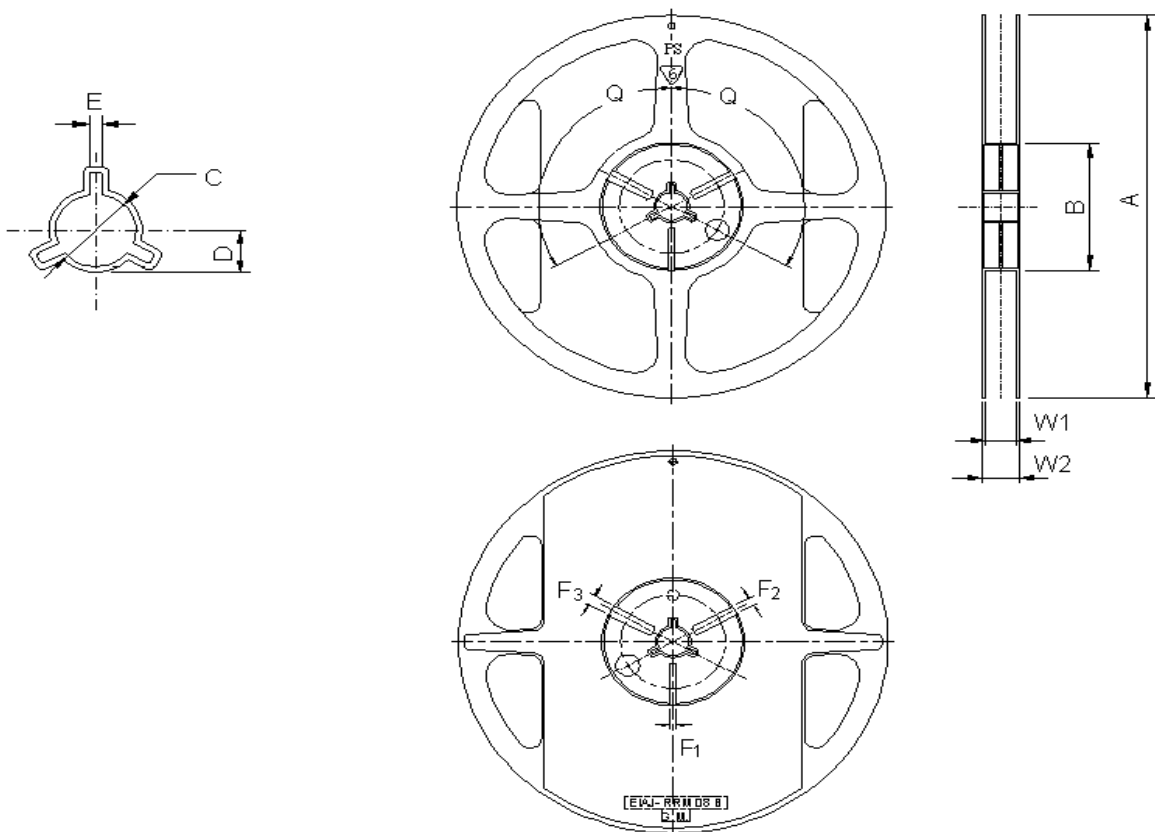

Title HSX321S QUARTZ CRYSTAL SPECIFICATION				Country of origin TAIWAN FACTORY THAILAND FACTORY CHINA FACTORY		
Date	Confirm	Check	Prepare	Spec. No.	Rev.	Page
2013/06/07	F. S. TSAI	Y. W. LEE	U. F. CHEN	X3S030000BA1H-U	0	6

(Table-2)

(UNIT: mm)

ITEM		MARK	DIMENSIONS · ANGLE	
FLANCE	Diameter	A	ϕ 180+0/-3	
	Inner Width	W1	9.3+/-0.3	
	Outer Width	W2	11.3+/-1.0	
HUB	Out Line diameter		B	ϕ 60.5+/-0.5
	Center Core slit	Width	F1	3.0+0.5/-0
			F2	4.0+0.5/-0
		F3	5.0+0.5/-0	
	Position		q	120deg
	Spindle diameter		C	ϕ 13.2+/-0.5
Key Ditch	Width	E	3.0+/-0.2	

c.) Storage condition

Temperature: +40deg.C Max.

Relative Humidity: 80% Max.



d.) Standard packing quantity

3,000PCS / REEL

e.) Material of the tape

Tape	Material
Carrier tape	PS Conductive
Top tape	Polyester

f.) Label contents

	
TYPE:	
SPEC.No.:	
Parts No.:	
LotNo.:	
FREQ.:	MHz
Q'TY:	PCS
HARMONY ELECTRONICS CORP.  HSF	

Sticks label for every reel.

Title HSX321S QUARTZ CRYSTAL SPECIFICATION				Country of origin TAIWAN FACTORY THAILAND FACTORY CHINA FACTORY		
Date	Confirm	Check	Prepare	Spec. No.	Rev.	Page
2013/06/07	F. S. TSAI	Y. W. LEE	U. F. CHEN	X3S030000BA1H-U	0	7

HARMONY ELECTRONICS CORP.

g.) Taping dimension

Leader	Cover-tape	The length of cover-tape in the leader is more than 400 mm including empty embossed area.
	Carrier-tape	After all products were packaged, must remain more than twenty pieces or 400 mm empty area, which should be sealed by cover-tape.
Terminal	Cover-tape	The tip of cover-tape shall be fixed temporary by paper tape and roll around the core of reel one round.
	Carrier-tape	The empty embossed area which are sealed by top cover-tape must remain more the 40 mm.

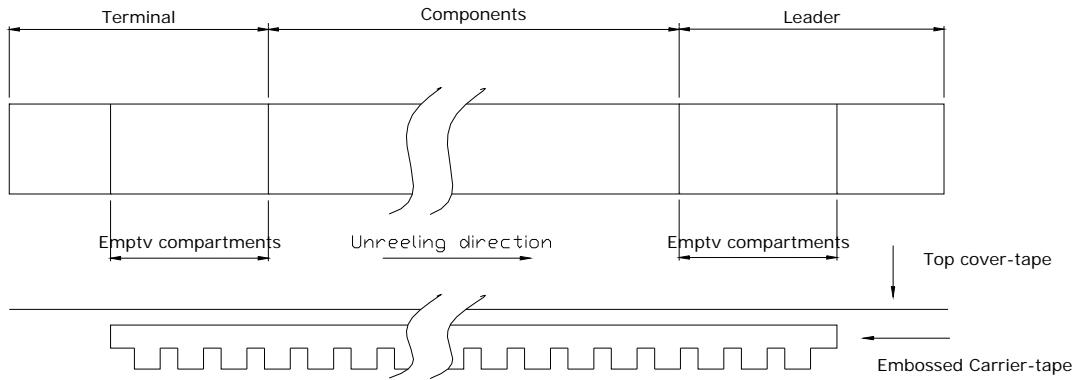

h.) Joint of tape

The carrier-tape and top cover-tape should not be jointed.

i.) Release strength of cover tape

It has to between 0.1N to 0.7N under following condition.

Pulling direction 165° to 180°

Speed 300mm/min.

Otherwise unless specified.

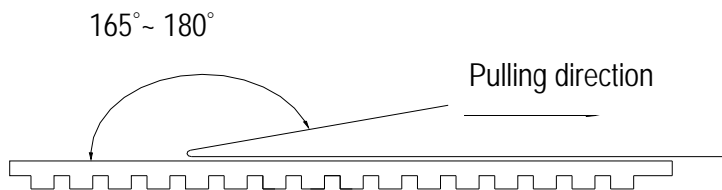

Other standards shall be based on JIS C 0806-1990.

Title HSX321S QUARTZ CRYSTAL SPECIFICATION				Country of origin TAIWAN FACTORY THAILAND FACTORY CHINA FACTORY		
Date	Confirm	Check	Prepare	Spec. No.	Rev.	Page
2013/06/07	F. S. TSAI	Y. W. LEE	U. F. CHEN	X3S030000BA1H-U	0	8

j.) Package

1.Reel : \varnothing 180

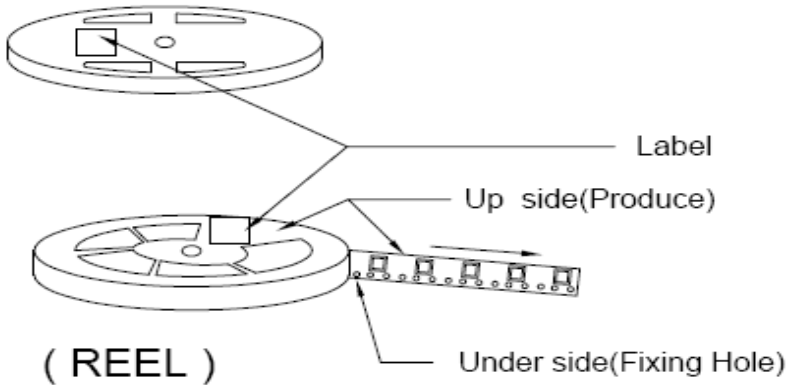

(REEL)

2. Carton One reel quantity:[1000pcs] &[3000pcs]

- ① Top and bottom with 2.3cm thickness foam-rubber cushion for protection.
- ② Carton's Q'TY:1~15 pcs.
- ③ Carton Type=A,B,C use 4 trigon pillar to fasten the Reel.
- ④ Need to add 3 pages dry agent in each outer box.

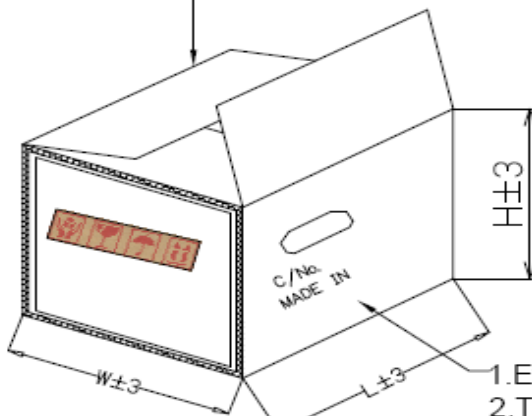
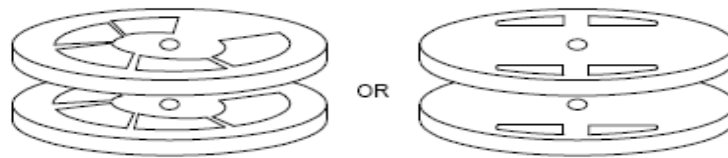
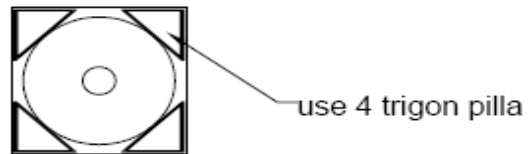

Carton Type	A	B	C	D
Produce Type	840/751	630/531/ 421	321/21	OTHER
Reel	15	15	15	1~7
L±3	200	200	200	195
W±3	200	200	200	195
H±3	230	230	230	150

(Carton)

1. Every Carton with 3 desiccant.
2. Top and bottom with 2.3cm thickness foam-rubber cushion for protection

Title HSX321S QUARTZ CRYSTAL SPECIFICATION				Country of origin TAIWAN FACTORY THAILAND FACTORY CHINA FACTORY		
Date	Confirm	Check	Prepare	Spec. No.	Rev.	Page
2013/06/07	F. S. TSAI	Y. W. LEE	U. F. CHEN	X3S030000BA1H-U	0	9

5. Mechanical Performance

Item		Test Methods	Specifications Code
1	Natural Drop	Drop 3 times from the height of 75cm onto min. 30mm thickness hard wooden board.	A
2	Vibration	Frequency 10-55Hz, Sine Wave full amplitude of 0.8mm to X, Y and Z 3 axes, Duration of 120min. to each direction.	A
3	Sealing Tightness	Leak Rate 1.0×10^{-8} Pa-m ³ /sec. Max. Measured by Helium leak detector. – Fine Leakage.	---
4	Solderability	After applying ROSIN Flux, dipping in solder bath at 245deg.C+/-5deg.C for 3+/-0.5 sec.	B
5	Substrate Bending	Mount a sample on board. Apply Pressure to the center of board until it is bent to 3 mm and hold for 5 ± 1 sec Pressure speed :0.5 mm / sec	A
6	Adhesion	Mount a sample on the circuit board. Apply pressure vertically to the side of specimen attached to the circuit board with the pressure jig. Pressure : 5N for 10+/-1 sec	A
7	Body strength	Apply pressure to the center of body with the R0.5 pressure jig. pressure :10N for 10+/-1sec	A

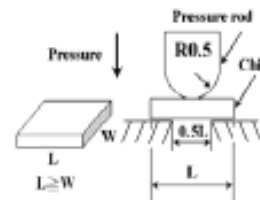
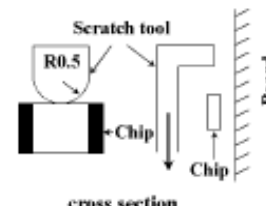
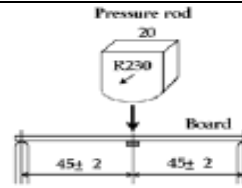

Title HSX321S QUARTZ CRYSTAL SPECIFICATION				Country of origin TAIWAN FACTORY THAILAND FACTORY CHINA FACTORY		
Date	Confirm	Check	Prepare	Spec. No.	Rev.	Page
2013/06/07	F. S. TSAI	Y. W. LEE	U. F. CHEN	X3S030000BA1H-U	0	10

6. Environment Performance

Item		Test Methods	Specifications Code
1	Humidity	Temperature 60°C +/-2°C ,RH 90~95%, Duration of 240 hours. Back to room temperature first, then in 1~2 hours, the component shall be checked.	A
2	Storage in Low Temperature	-40deg.C +/-2deg.C, Duration of 240 hours. Back to the room temperature first, then in 1~2 hours, the component shall be checked.	A
3	Storage in High Temperature	+85deg.C +/-2deg.C, Duration of 240 hours. Back to the room temperature first, then in 1~2 hours, the component shall be checked.	A
4	Temperature cycles	-40deg.C +/-2deg.C (30min) ↔ +85deg.C +/-2deg.C (30min) 25 cycles. Back to the room temperature first, then in 1~2 hours, the component shall be checked.	A

Specifications code	Specifications
A	Frequency variation shall be within +/-5ppm and equivalent resistance shall be within +/-15% or 2Ω
B	More than 90% of lead shall be covered by new solder.

Title HSX321S QUARTZ CRYSTAL SPECIFICATION				Country of origin TAIWAN FACTORY THAILAND FACTORY CHINA FACTORY		
Date	Confirm	Check	Prepare	Spec. No.	Rev.	Page
2013/06/07	F. S. TSAI	Y. W. LEE	U. F. CHEN	X3S030000BA1H-U	0	11

7. Supplement

7.1.Soldering

7.2.Please stay with our proposed reflow condition and do then soldering 2 times max.

Available for Lead Free Soldering

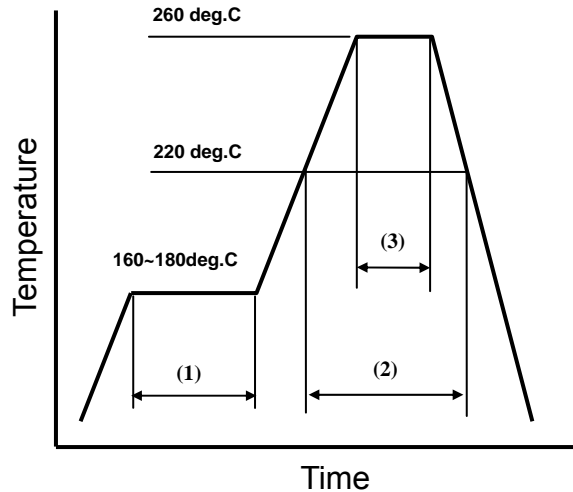

(1)	Preheat	160~180 deg.C	120sec.
(2)	Primary heat	220 deg.C	60sec.
(3)	Peak	260 deg.C	10sec. Max.

7.3.Land pattern layout(Example)

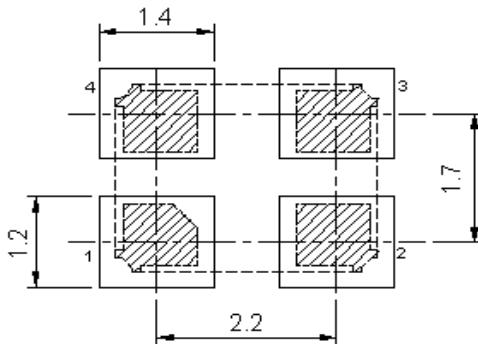

7.4.Solder iron (Example)

Bit temp.:350°C max.,Time:3sec max. ,Each terminal solder a 1 time max.

Title HSX321S QUARTZ CRYSTAL SPECIFICATION				Country of origin TAIWAN FACTORY THAILAND FACTORY CHINA FACTORY		
Date	Confirm	Check	Prepare	Spec. No.	Rev.	Page
2013/06/07	F. S. TSAI	Y. W. LEE	U. F. CHEN	X3S030000BA1H-U	0	12

7.5.Mounting

This component is designed for automatic insertion.
However, you are requested to do the trial with your insertion machine in order to be sure of proper operation and no damage of component.
Please pay attention to board warp which may damage the component and cause Soldering Process.

7.6.Cleaning

Cleaning liquid which corrodes Nickel shall not be used
It may cause the problem on the surface, color, marking etc.
Ultra-sonic cleaning is possible, however, you are requested to check on your board.
Because we only checked as single unit.

7.7.Storage

Please keep away from high temperature and high humidity ,which may cause put solderbility. No direct Sunlight, No dew as well.

Title HSX321S QUARTZ CRYSTAL SPECIFICATION				Country of origin TAIWAN FACTORY THAILAND FACTORY CHINA FACTORY		
Date	Confirm	Check	Prepare	Spec. No.	Rev.	Page
2013/06/07	F. S. TSAI	Y. W. LEE	U. F. CHEN	X3S030000BA1H-U	0	13

8. Flow Chart

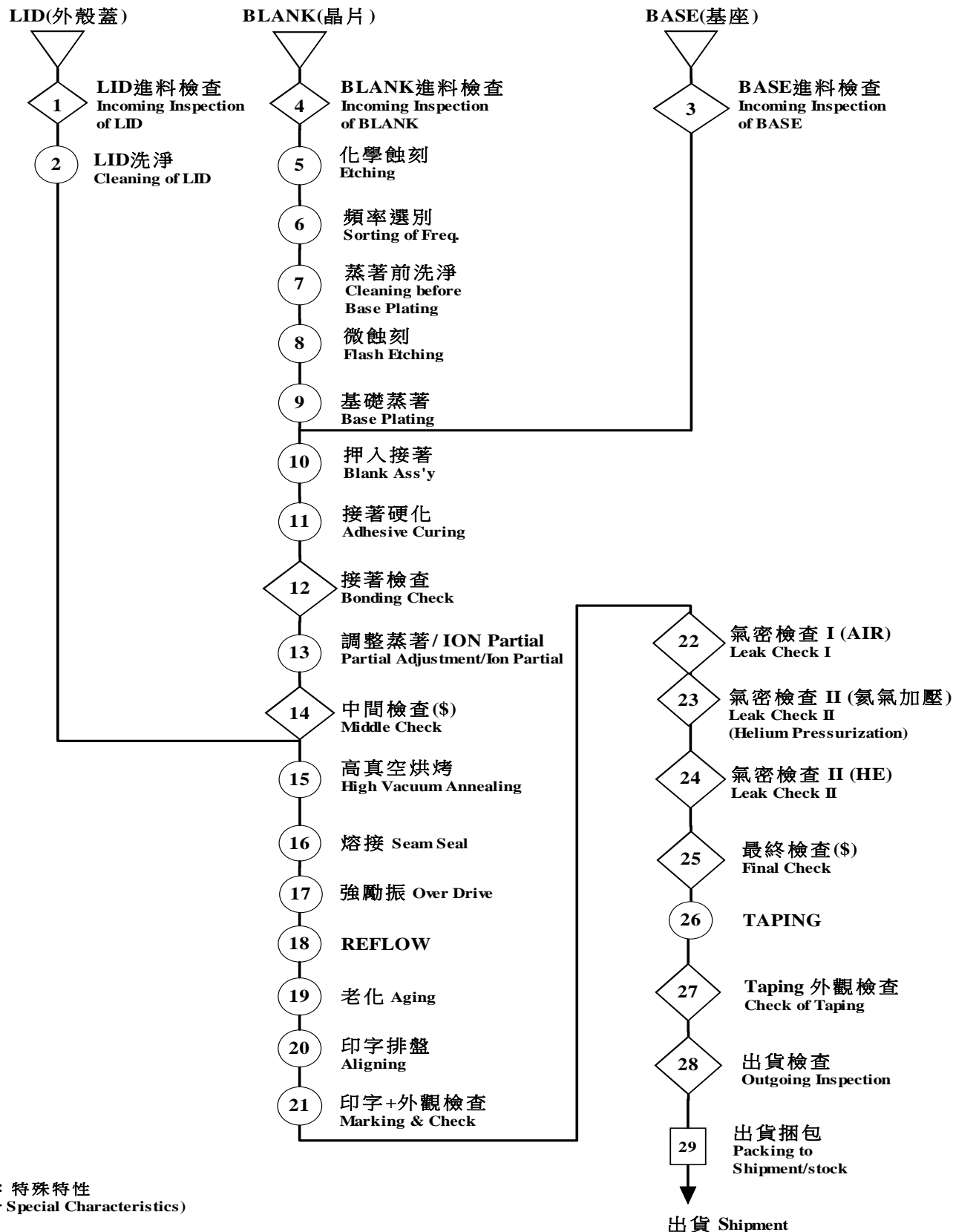

Title HSX321S QUARTZ CRYSTAL SPECIFICATION				Country of origin TAIWAN FACTORY THAILAND FACTORY CHINA FACTORY		
Date	Confirm	Check	Prepare	Spec. No.	Rev.	Page
2013/06/07	F. S. TSAI	Y. W. LEE	U. F. CHEN	X3S030000BA1H-U	0	14

9. Environmental Workload Chemical Substance Components List

Environmental Workload Chemical Substance Components List		
Chemical Substance Components	TYPE	H(D)SX321S
	PERCENTAGE	
		20.5(mg) ppm
Si		0.04715 9.6658
Au		0.15785 32.3593
Co & Co Compound		1.21770 249.6285
Mo & Mo Compound		0.04100 8.4050
Ag		0.42640 87.4120
Cu		0.11890 24.3745
Cr & Cr Compound		0.04100 8.4050
Al		5.09630 1044.7415
Mn & Mn Compound		0.02460 5.0430
W & W Compound		0.19885 40.7643
Ni & Ni Compound		3.06680 628.6940
Fe		4.14715 850.1658

Title HSX321S QUARTZ CRYSTAL SPECIFICATION				Country of origin TAIWAN FACTORY THAILAND FACTORY CHINA FACTORY		
Date	Confirm	Check	Prepare	Spec. No.	Rev.	Page
2013/06/07	F. S. TSAI	Y. W. LEE	U. F. CHEN	X3S030000BA1H-U	0	15

