

Metal Oxide Varistor (MOV) Data Sheet

Features

- Wide operating voltage (V_{1mA}) range from 18V to 1800V
- Fast responding to transient over-voltage
- Large absorbing transient energy capability
- Low clamping ratio and no follow-on current
- Meets MSL level 1, per J-STD-020
- Operating Temperature: $-40^{\circ}\text{C} \sim +105^{\circ}\text{C}$
- Storage Temperature: $-40^{\circ}\text{C} \sim +125^{\circ}\text{C}$
- Safety certification: UL: E327997
CSA: 246579
VDE: 40027827



Applications

- Transistor, diode, IC, thyristor or triac semiconductor protection
- Surge protection in consumer electronics
- Surge protection in industrial electronics
- Surge protection in electronic home appliances, gas and petroleum appliances
- Relay and electromagnetic valve surge absorption

Part number code

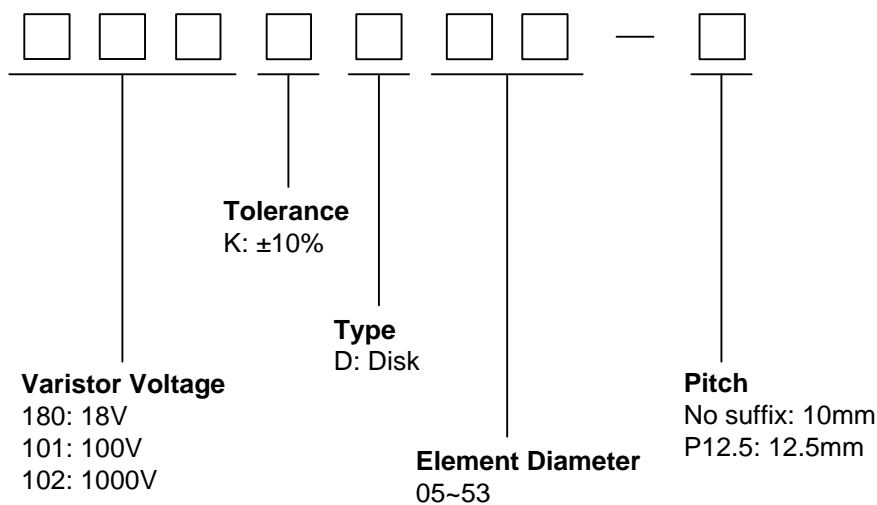

Dimensions

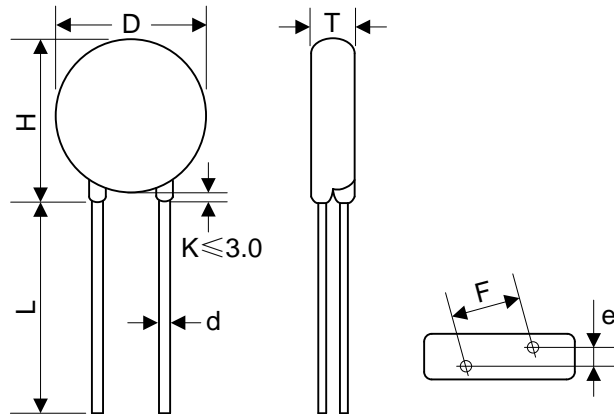

Table 1	
Unit: mm	
Symbol	Dimension
H	27.0~31.5
L(min.)	20.0
D	25.0~28.0
F(±1.0)	10.0/12.5
T	Table 2
e(±0.8)	Table 2
d(±0.1)	1.0

Table 2					
Unit: mm					
Model	T	e	Model	T	e
180K	2.5~4.8	1.7	361K	3.4~5.9	2.9
220K	2.6~4.9	1.8	391K	3.5~6.1	3.0
270K	2.6~5.0	2.0	431K	3.7~6.4	3.2
330K	2.7~5.2	1.9	471K	3.8~6.7	3.4
390K	2.6~5.5	2.0	511K	3.9~7.0	3.6
470K	2.7~5.1	2.1	561K	4.1~7.3	3.8
560K	2.8~5.4	2.3	621K	4.3~7.6	4.1
680K	2.9~5.7	2.6	681K	4.5~7.8	4.4
820K	2.6~4.5	2.0	751K	4.8~8.0	4.5
101K	2.9~4.6	2.2	781K	4.9~8.1	4.6
121K	2.9~4.8	2.4	821K	5.1~8.4	4.8
151K	2.7~4.9	2.0	911K	5.3~8.9	5.2
181K	2.8~5.2	2.1	102K	5.9~9.5	5.2
201K	2.9~5.2	2.2	112K	6.3~10.1	5.6
221K	3.0~5.3	2.3	122K	6.4~10.7	6.0
241K	3.1~5.8	2.4	142K	7.4~12.6	6.8
271K	3.1~5.3	2.6	162K	7.9~13.2	7.6
301K	3.2~5.5	2.7	182K	8.1~14.5	8.4
331K	3.2~5.7	2.7			

Electrical characteristics

Part Number	Maximum Allowable Voltage		Varistor Voltage	Maximum Clamping Voltage		Withstanding Surge Current	Maximum Energy (10/1000μs)	Rated Power	Typical Capacitance (Reference)
	V _{AC} (V)	V _{DC} (V)	V _{1mA} (V)	I _P (A)	V _C (V)	I (A)	(J)	(W)	@1KHz (pf)
180KD25	11	14	18(15~21.6)	30	36	4500	20	0.25	45000
220KD25	14	18	22(19.5~26)	30	43	4500	25	0.25	29000
270KD25	17	22	27(24~31)	30	53	4500	30	0.25	26500
330KD25	20	26	33(29.5~36.5)	30	65	4500	35	0.25	18000
390KD25	25	31	39(35~43)	30	77	4500	40	0.25	13500
470KD25	30	38	47(42~52)	30	93	4500	50	0.25	11500
560KD25	35	45	56(50~62)	30	110	4500	60	0.25	10500
680KD25	40	56	68(61~75)	30	135	4500	70	0.25	9050
820KD25	50	65	82(74~90)	150	135	15000	80	1.2	7700
101KD25	60	85	100(90~110)	150	165	15000	100	1.2	6300
121KD25	75	100	120(108~132)	150	200	15000	120	1.2	5200
151KD25	95	125	150(135~165)	150	250	15000	160	1.2	4300
181KD25	115	150	180(162~198)	150	300	15000	175	1.2	3500
201KD25	130	170	200(180~220)	150	340	15000	190	1.2	3200
221KD25	140	180	220(198~242)	150	360	15000	200	1.2	2900
241KD25	150	200	240(216~264)	150	395	15000	220	1.2	2650
271KD25	175	225	270(243~297)	150	455	15000	255	1.2	2400
301KD25	190	250	300(270~330)	150	500	15000	275	1.2	2100
331KD25	210	275	330(297~363)	150	550	15000	300	1.2	1900
361KD25	230	300	360(324~396)	150	595	15000	330	1.2	1750
391KD25	250	320	390(351~429)	150	650	15000	360	1.2	1600
431KD25	275	350	430(387~473)	150	710	15000	380	1.2	1500
471KD25	300	385	470(423~517)	150	775	15000	400	1.2	1400
511KD25	320	415	510(459~561)	150	845	15000	420	1.2	1250
561KD25	350	460	560(504~616)	150	925	15000	440	1.2	1150
621KD25	385	505	620(558~682)	150	1025	15000	450	1.2	1050
681KD25	420	560	680(612~748)	150	1120	15000	460	1.2	950
751KD25	460	615	750(675~825)	150	1240	15000	510	1.2	850
781KD25	485	640	780(702~858)	150	1290	15000	530	1.2	850
821KD25	510	670	820(738~902)	150	1355	15000	570	1.2	800
911KD25	550	745	910(819~1001)	150	1500	15000	620	1.2	700
102KD25	625	825	1000(900~1100)	150	1650	15000	685	1.2	650
112KD25	680	895	1100(990~1210)	150	1815	15000	720	1.2	600
122KD25	750	990	1200(1080~1320)	150	1980	15000	792	1.2	550
142KD25	880	1140	1400(1260~1540)	150	2310	15000	850	1.2	500
162KD25	1000	1280	1600(1440~1760)	150	2640	15000	970	1.2	450
182KD25	1100	1465	1800(1620~1980)	150	2970	15000	1092	1.2	400

Notes: 1. The tolerance of varistor voltage between 18V and 27V is more than 10%.

2. Leakage Current (@83% of V_{1mA}): IR≤50μA (180K~680K)
IR≤40μA (820K~182K)

Electrical Ratings

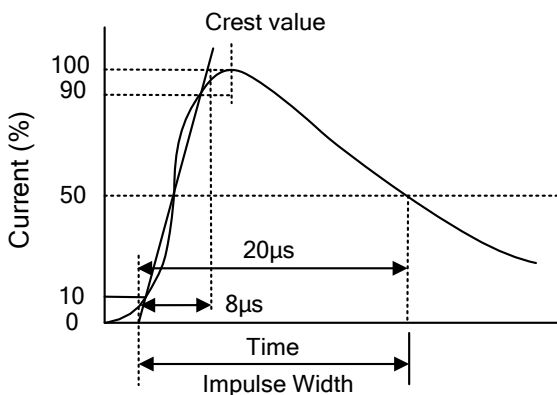
Items	Test Condition/Description	Requirement					
Varistor Voltage	The voltage between two terminals with the specified measuring current 1mA.DC applied is called Vb.						
Maximum Allowable Voltage	The recommended maximum sine wave voltage (RMS) or the Maximum DC voltage can be applied continuously.						
Maximum Clamping Voltage	<p>The maximum voltage between two terminals with the specification standard impulse current. Applied waveform: 8/20μs</p> 						
Rated Wattage	The maximum average power that can be applied within the specified ambient temperature.						
Energy	The maximum energy within the varistor voltage change of ±10% when one impulse of 10/1000μs or 2ms is applied.						
Withstanding Surge Current	The maximum current within the varistor voltage change of ±10% with the standard impulse current (8/20μs) applied one time.						
Varistor Voltage Temp. Coefficient	$\left \frac{V_{1mA@105^{\circ}C} - V_{1mA@25^{\circ}C}}{V_{1mA@25^{\circ}C}} \times \frac{1}{80} \times 100\% (\%/^{\circ}C) \right $ $\left \frac{V_{1mA@-40^{\circ}C} - V_{1mA@25^{\circ}C}}{V_{1mA@25^{\circ}C}} \times \frac{1}{65} \times 100\% (\%/^{\circ}C) \right $	≤0.05%/°C					
Surge Life	<p>The change of Vb shall be measured after the impulse listed below which is applied 10,000 times continuously with the interval of ten seconds at room temperature.</p> <table border="1" data-bbox="443 1888 1203 2011"> <tr> <td rowspan="2">25Φ series</td> <td>180K to 680K</td> <td>250A (8/20μs)</td> </tr> <tr> <td>820K to 182K</td> <td>450A (8/20μs)</td> </tr> </table>	25Φ series	180K to 680K	250A (8/20μs)	820K to 182K	450A (8/20μs)	$\frac{\Delta V_b}{V_b} \leq \pm 10\%$
25Φ series	180K to 680K		250A (8/20μs)				
	820K to 182K	450A (8/20μs)					

Soldering Recommendation

Wave Lead Free Soldering Recommendation

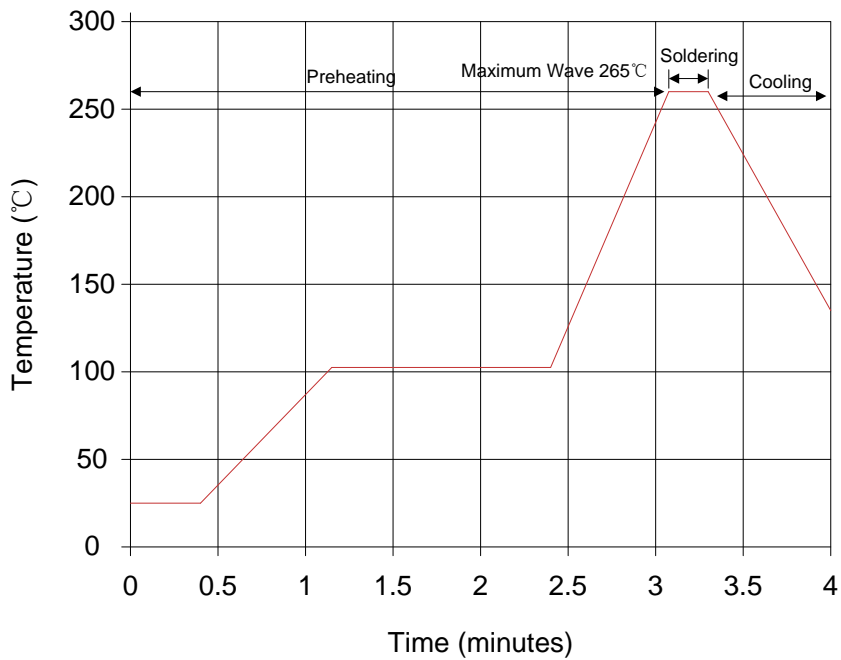

Item	Conditions
Peak Temperature	265°C
Dipping Time	10 seconds (max.)
Soldering	1 time

Recommendation Reworking Conditions with Soldering Iron

Item	Conditions
Temperature of Soldering Iron-tip	360°C (max.)
Soldering Time	3 seconds (max.)
Distance from Varistor	2mm (min.)

Mechanical Characteristics

Items	Test conditions / Methods	Specifications								
Tensile Strength of Terminals	Gradually applying the force specified and keeping the unit fixed for 10±1 sec. <table border="1"> <thead> <tr> <th>Terminal diameter (mm)</th> <th>Force (kg)</th> </tr> </thead> <tbody> <tr> <td>0.5<d≤0.8</td> <td>1.0</td> </tr> <tr> <td>0.8<d≤1.25</td> <td>2.0</td> </tr> <tr> <td>1.25<d</td> <td>4.0</td> </tr> </tbody> </table>	Terminal diameter (mm)	Force (kg)	0.5<d≤0.8	1.0	0.8<d≤1.25	2.0	1.25<d	4.0	No visible damage ΔV _{1mA} /V _{1mA} ≤5%
Terminal diameter (mm)	Force (kg)									
0.5<d≤0.8	1.0									
0.8<d≤1.25	2.0									
1.25<d	4.0									
Bending Strength of Terminals	Hold specimen and apply the force specified below to each lead. Bend the specimen to 90°, then return to the original position. Repeat the procedure in the opposite direction. <table border="1"> <thead> <tr> <th>Terminal diameter (mm)</th> <th>Force (kg)</th> </tr> </thead> <tbody> <tr> <td>0.5<d≤0.8</td> <td>0.5</td> </tr> <tr> <td>0.8<d≤1.25</td> <td>1.0</td> </tr> <tr> <td>1.25<d</td> <td>2.0</td> </tr> </tbody> </table>	Terminal diameter (mm)	Force (kg)	0.5<d≤0.8	0.5	0.8<d≤1.25	1.0	1.25<d	2.0	No visible damage ΔV _{1mA} /V _{1mA} ≤5%
Terminal diameter (mm)	Force (kg)									
0.5<d≤0.8	0.5									
0.8<d≤1.25	1.0									
1.25<d	2.0									
Vibration	Frequency range: 10~55 Hz Amplitude: 0.75mm or 98m/s ² Direction: 3 mutually perpendicular directions, 2hrs each.	No visible damage ΔV _{1mA} /V _{1mA} ≤5%								
Solder ability	Solder Temp: 245±5℃ Dipping Time: 2±0.5 sec	At least 95% of terminal electrode is covered by new solder								
Resistance to Soldering Heat	Solder Temp: 260±5℃ Dipping Time: 10±1 sec	No visible damage ΔV _{1mA} /V _{1mA} ≤10%								

Reliability

Items	Test conditions / Methods	Specifications															
High Temperature Storage	Ambient Temp: 125±2℃ Duration: 1000hrs	ΔV _{1mA} /V _{1mA} ≤5%															
Low Temperature Storage	Ambient Temp: -40±2℃ Duration: 1000hrs	ΔV _{1mA} /V _{1mA} ≤5%															
Humidity	Ambient Temp: 40±2℃, 90~95% R.H. Duration: 1000hrs	ΔV _{1mA} /V _{1mA} ≤5%															
Temperature Cycle	The conditions shown below shall be repeated 5 cycles <table border="1"> <thead> <tr> <th>Step</th> <th>Temperature (℃)</th> <th>Period (minutes)</th> </tr> </thead> <tbody> <tr> <td>1</td> <td>-40±3</td> <td>30±3</td> </tr> <tr> <td>2</td> <td>Room temperature</td> <td>15±3</td> </tr> <tr> <td>3</td> <td>125±3</td> <td>30±3</td> </tr> <tr> <td>4</td> <td>Room temperature</td> <td>15±3</td> </tr> </tbody> </table>	Step	Temperature (℃)	Period (minutes)	1	-40±3	30±3	2	Room temperature	15±3	3	125±3	30±3	4	Room temperature	15±3	No visible damage ΔV _{1mA} /V _{1mA} ≤5%
Step	Temperature (℃)	Period (minutes)															
1	-40±3	30±3															
2	Room temperature	15±3															
3	125±3	30±3															
4	Room temperature	15±3															
High Temperature Load	Ambient Temp: 105±2℃ Duration: 1000hrs Load: Max. Allowable Voltage In AC eara.	ΔV _{1mA} /V _{1mA} ≤10%															
Damp Heat Load	Ambient Temp: 40±2℃, 90~95% R.H. Duration: 1000hrs Load: Max. Allowable Voltage	No visible damage ΔV _{1mA} /V _{1mA} ≤10%															
Voltage Proof	Metal balls method, 2500Vac 1 min.	No visible damage															

Maximum Surge Current Derating Curve

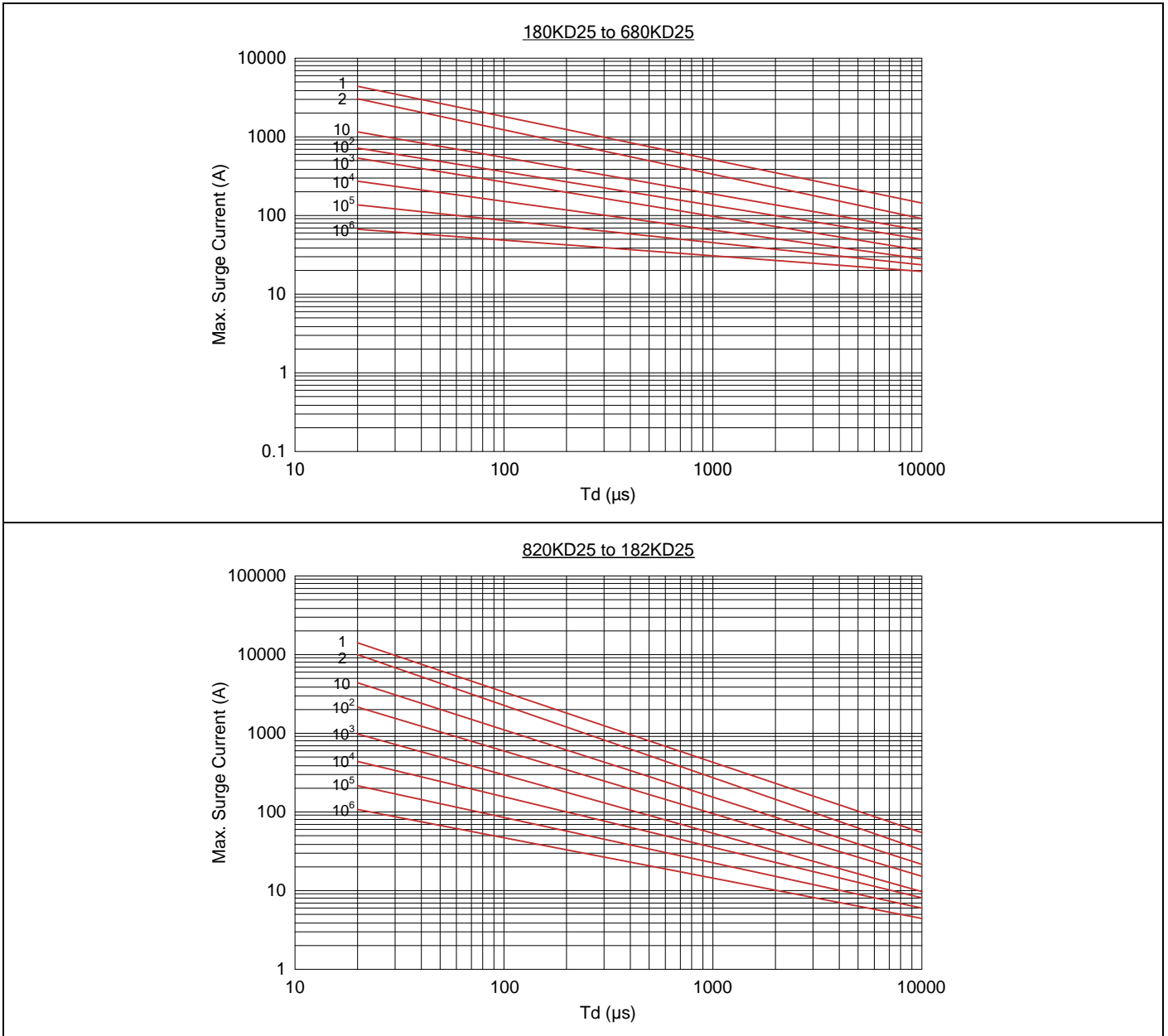

Maximum Leakage Current and Maximum Clamping Voltage Curve

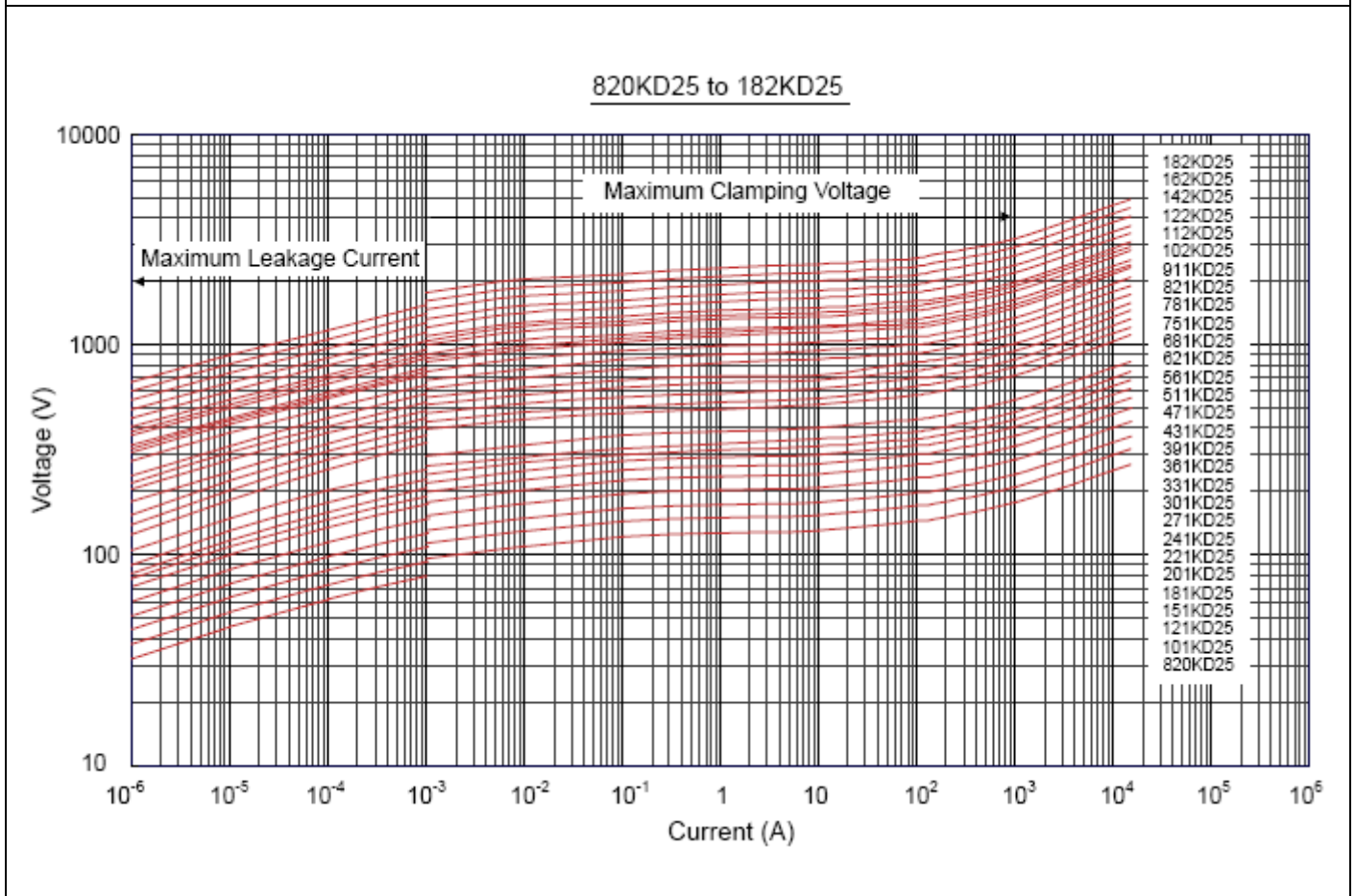
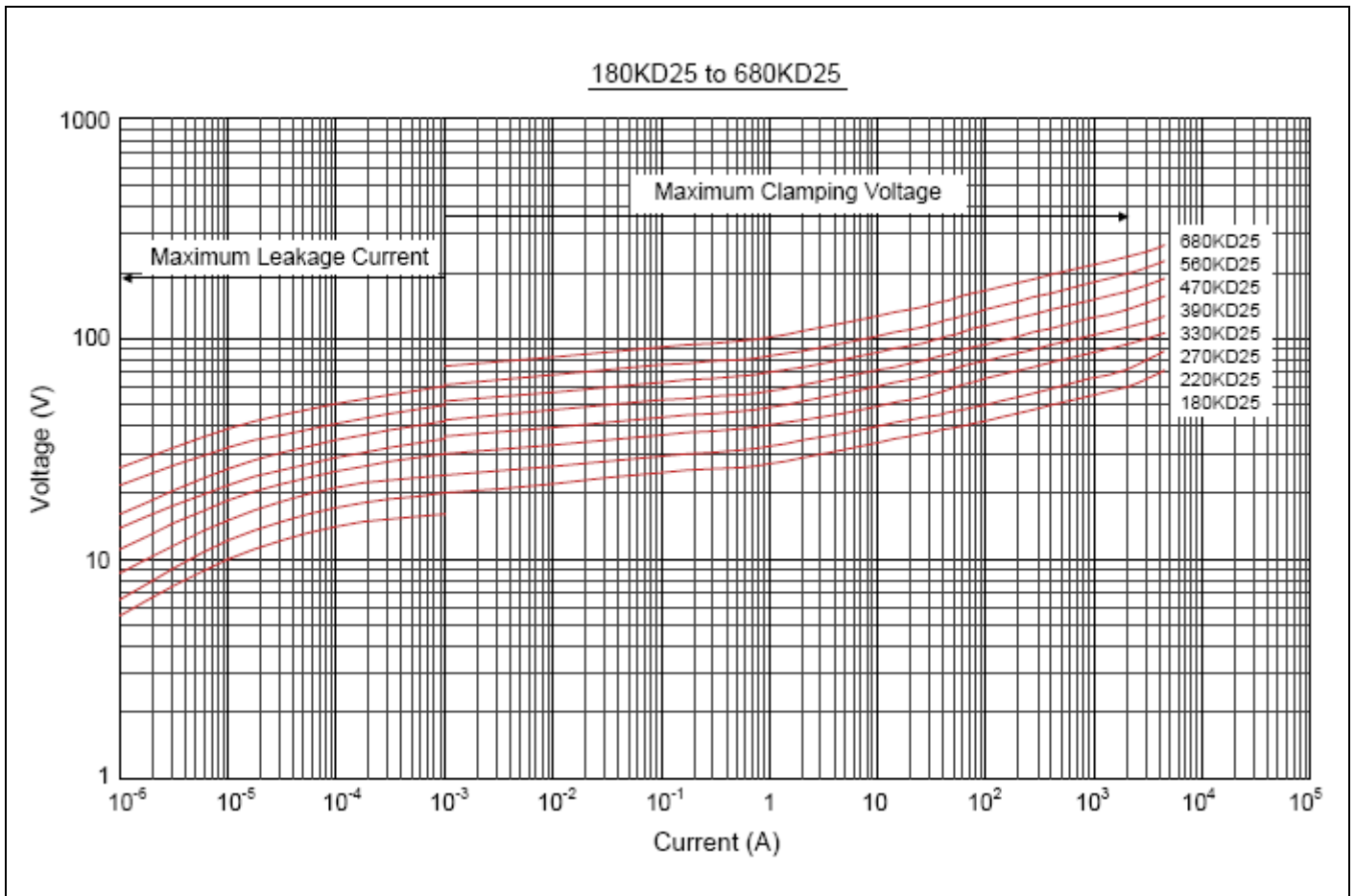

Marking code

① Brightking Logo
 ② Varistor Voltage
 ③ UL Accreditation Logo
 ④ CSA Accreditation Logo
 ⑤ VDE Accreditation Logo
 ⑥ “J” is High Surge Code, no “J” is Standard Surge
 ⑦ Disk Size
 ⑧ Product Line Code (“Y” may be A(a) thru Z(z))
 ⑨ Date Code

Quantity

Packaging Dimensions (Unit: mm)	Quantity
Exposure in bulk 	100pcs/bag 4bags/box (180K~621K)
	50pcs/bag 4bags/box (681K~182K)
Cut the feet in bulk 	100pcs/bag 4bags/box (180K~621K)
	50pcs/bag 4bags/box (681K~182K)