

SPECIFICATIONS

1. Application

- 1) This document is applicable to the crystal unit that are delivered to Beijing Shenzhen Shudun Science and Technology Co., Ltd. from Seiko Epson Corp.
- 2) RoHS compliant
FC-135R contains lead in Low melting type solder which is exempted in RoHS directive.
- 3) This Product supplied (and any technical information furnished, if any) by Seiko Epson Corporation shall not be used for the development and manufacture of weapon of mass destruction or for other military purposes.
Making available such products and technology to any third party who may use such products or technologies for the said purposes are also prohibited.
- 4) This product listed here is designed as components or parts for electronics equipment in general consumer use.
We do not expect that any of these products would be incorporated or otherwise used as a component or part for the equipment, which requires an systems, and medical equipment, the functional purpose of which is to keep extra high reliability, such as satellite, rocket and other space life.

2. Product No. / Model

The product No. of this crystal unit is X1A000141000600.
The model is FC-135R.

3. Packing

It is subject to the packing standard of Seiko Epson Corp.

4. Warranty

Defective parts which originate with us are replaced free of charge in the case of defects being found with 12 months after delivery.

5. Amendment and/or termination

Amendment and/or termination of this specification is subject to the agreement between the two parties.

6. Contents

Item No.	Item	Page
[1]	Absolute maximum ratings	2
[2]	Operating range	2
[3]	Static characteristics	2
[4]	Environmental and Mechanical characteristics	3 to 4
[5]	Dimensions and Internal connection	5
[6]	Recommended soldering pattern and Marking layout	6
[7]	Notes	7

[1] Absolute maximum ratings

No.	Item	Symbol	Rating value			Unit	Note
			Min.	Typ.	Max.		
1	Storage temperature range	T_stg	- 55		+ 125	°C	Suppose to be within CI STD at + 25 °C ± 3 °C.
2	Maximum level of drive	GL		0.5		μW	

[2] Operating range

No.	Item	Symbol	Rating value			Unit	Note
			Min.	Typ.	Max.		
1	Operating temperature range	T_use	- 40		+ 85	°C	
2	Level of drive	DL	0.01	0.1	0.5	μW	
3	Vibration mode		Fundamental				

[3] Static characteristics

No.	Item	Symbol	Value	Unit	Conditions	
1	Nominal Frequency	f_nom	32.768	kHz		
2	Frequency tolerance	f_tol	± 20	× 10 ⁻⁶	CL = 6 pF Ta = + 25 ± 3 °C Level of drive : 0.1 μW Not include aging	
3	Motional resistance	R1	50 Max.	kΩ	CI meter : Saunders 140B Level of drive : 0.5 μW	
4	Motional capacitance	C1	3.4 Typ.	fF		
5	Shunt capacitance	C0	1.0 Typ.	pF		
6	Frequency temperature characteristics	Turnover temperature	Ti	+ 25 ± 5	°C	Values are calculated by The frequencies at + 10, + 25, + 40 °C with C-MOS circuit.
		Parabolic coefficient	B	- 0.04 Max.	× 10 ⁻⁶ /°C ²	
7	Isolation resistance	IR	500 Min.	MΩ	DC 100 V ± 15, 60 seconds Between terminal # 1 and terminal # 2	
8	Frequency Aging	f_age	± 3	× 10 ⁻⁶ /year	Ta = + 25 °C ± 3 °C Level of drive : 0.1 μW	

[4] Environmental and Mechanical characteristics

No.	Items	Value	Conditions
1	Shock resistance	*3 Δ f/f : $\pm 15 \times 10^{-6}$	100 g dummy(EPSON Standard), Natural drop from 1 500 mm height on to the concrete. 3 directions \times 10 times *2
2	Vibration resistance	*3 Δ f/f : $\pm 3 \times 10^{-6}$	10 Hz to 55 Hz amplitude 0.75 mm 55 Hz to 500 Hz acceleration 98 m/s ² 10 Hz \rightarrow 500 Hz \rightarrow 10 Hz 15 min./cycle 6 h (2 hours , 3 directions) *2
3	Soldering heat resistance	Δ f/f : $\pm 8 \times 10^{-6}$	IPC/JEDEC J-STD-020D.1 Reflow (3 times)
4	High temperature storage	*3 Δ f/f : $\pm 10 \times 10^{-6}$	+ 125 °C \times 1 000 h *1
		*3 Δ f/f : $\pm 7 \times 10^{-6}$	+ 85 °C \times 1 000 h *1
5	Low temperature storage	*3 Δ f/f : $\pm 15 \times 10^{-6}$	- 55 °C \times 1 000 h *1
6	High temperature and humidity	*3 Δ f/f : $\pm 10 \times 10^{-6}$	+ 85 °C \times 85 %RH \times 1000 h *1
7	Temperature cycle	*3 Δ f/f : $\pm 10 \times 10^{-6}$	- 55 °C \leftrightarrow + 125 °C 30 minutes at each temperature \times 100 cycles *1
8	Sealing	*3 1 \times 10 ⁻⁸ hPa \cdot l / s Max.	For He leak detector
9	Shear	No peeling-off at a soldered part	20 N press for 10 \pm 1 s. Ref. IEC 60068-2-21
10	Pull - off	No peeling-off at a soldered part	20 N press for 10 \pm 1 s. Ref. IEC 60068-2-21
11	Substrate bending	No peeling-off at a soldered part	Bend width reaches 3 mm and hold for 5 s \pm 1 s \times 1 time Ref. IEC 60068-2-21
12	Solvent resistance	The marking shall be legible	Ref. JIS C 0052 or IEC 60068-2-45

< Notes >

1. *1 Each test done independently.
2. *2 Measuring 2 h to 24 h later leaving in room temperature after each test. Drive level : 0.5 μ W
- *3 Pre conditionings

1. + 125 °C \times 24 h to + 85 °C \times 85 %RH \times 168 h \pm 1 h \rightarrow reflow 3 times

2. Initial value shall be after 24 h at room temperature.

Shift of series resistance at before and after the test should be less than ± 30 % or less than ± 20 k Ω .

In case high temperature storage(+ 125 °C \times 1 000 h), Soldering heat resistance, shift of series resistance at before and after the test should be less than ± 40 % or ± 30 k Ω .

◆ Reflow condition (follow to IPC / JEDEC J-STD-020D.1)

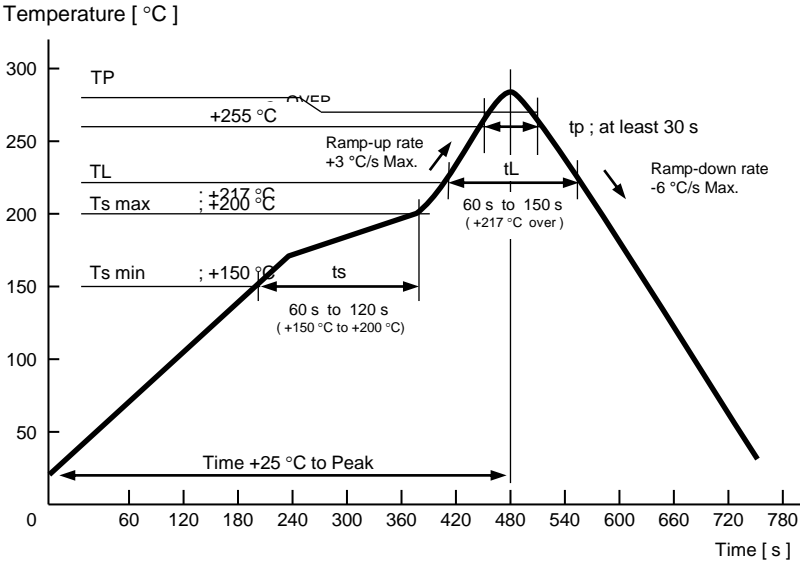

[5] Dimensions and Marking layout

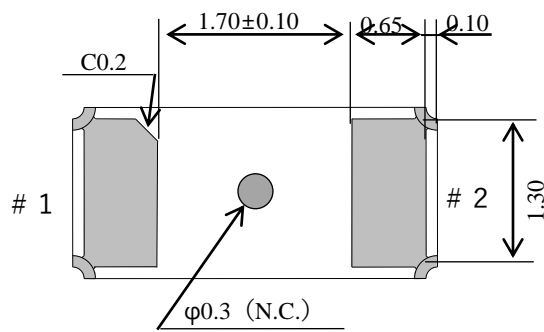
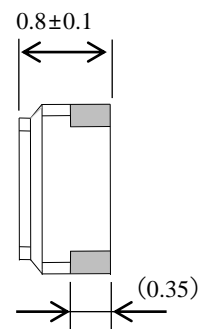
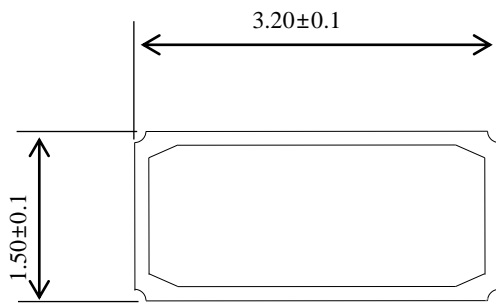

Internal connection

(TOP VIEW)

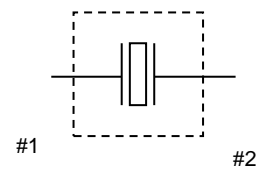

Terminal : Au plating

[6] Recommended soldering pattern and Marking layout

1. Recommended soldering pattern (Unit : mm)

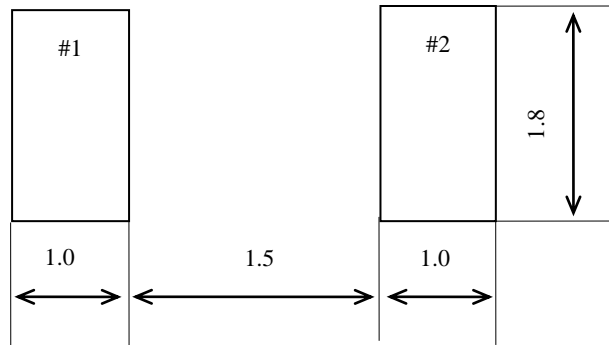

2. Marking layout

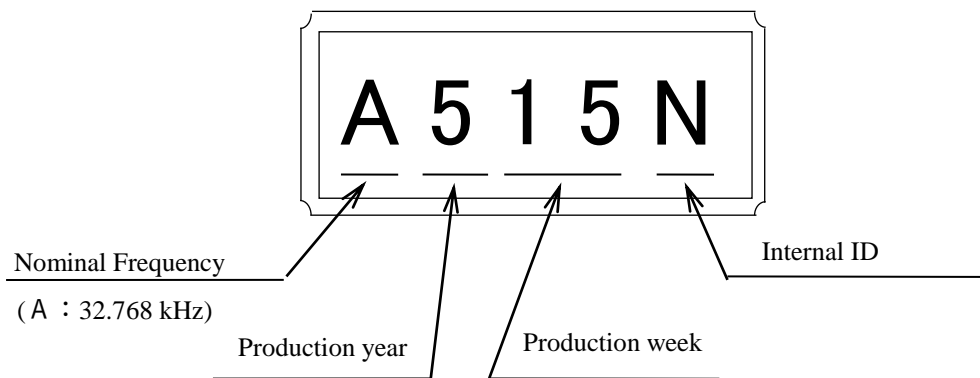

* The above marking layout shows only marking contents and their approximate position and it is not for font size and exact position

[7] Notes

1. Max three (3) times reflow is allowed. Once miss soldering is happened, hand work soldering by soldering iron is recommended. (+ 350 °C × within 5 s)
2. Patterning should be followed by our recommended one.
3. Applying excessive excitation force to the crystal unit may cause deterioration damage.
4. Unless adequate negative resistance is allocated in the oscillation circuit, start up time of oscillation may be increased, or no oscillation may occur.

How to check the negative resistance.

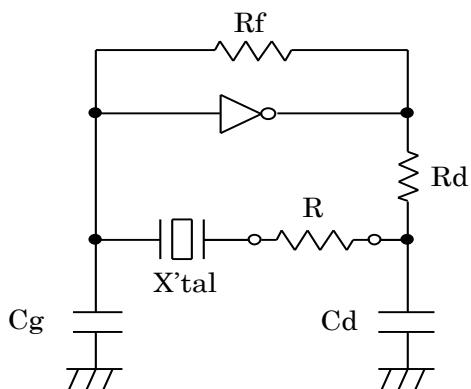

- (1) Connect the resistance (R) to the circuit in series with the crystal unit.
- (2) Adjust R so that oscillation can start (or stop).
- (3) Measure R when oscillation just start (or stop) in above (2).
- (4) Get the negative resistance
 $-R = R + CI$ value.
- (5) Recommended -R
 $|-R| > CI \times (5 \sim 10)$

5. The shortest patterning line on board is recommendable.
Too long line on board may cause of abnormal oscillation.
6. To avoid mull function, no pattern under or near the crystal is allowed.
7. This device must be stored at the normal temperature and humidity conditions before mounting on a board.
8. Too much exciting shock or vibration may cause deterioration on damage.
Depending on the condition such as a shock in assembly machinery, the products may be damaged.
Please check your condition in advance to maintain shock level to be smallest.
9. Depending on the conditions, ultrasonic cleaning may cause resonant damage of the internal crystal unit. Since we are unable to determine the conditions (type of cleaning unit, power, time, conditions inside the bath, etc.) to be used in your company, we cannot guarantee the safety of this unit when it is cleaned in an ultrasonic cleaner.
10. Ink marking may be damaged by some kind of solvent, please take precautions when choosing solvent by your selves.
11. Please refer to packing specification regarding how to storage the products in the pack.