

BL 0605 Series

Multilayer Chip Baluns

Features

- ❖ Monolithic SMD with small, low-profile and light-weight type.
- ❖ RoHS compliant

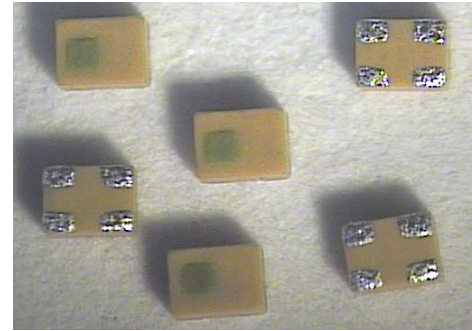

Applications

- ❖ 1.805 ~ 2.170 GHz wireless communication systems.

Specifications

Part Number	Frequency Range (MHz)	Unbalanced Impedance (ohm)	Balance Impedance (ohm)	Insertion Loss (dB)	VSWR @BW	Phase Difference (degree)	Amplitude Difference (dB)
BL0605-10L2000NA_	1805 ~ 2170	50	100	0.7 max.	2.0 max.	180 ± 10	3.0 max.

Q'ty/Reel (pcs) : 10,000
 Operating Temperature Range : -40 ~ +85 °C
 Storage Temperature Range : -40 ~ +85 °C
 Storage Period : 12 months max.*
 *12 months in vacuum sealed bag and 1 week after opened. Please keep unused parts in vacuum sealed bags.
 Solder Paste : SAC 305 type is recommended.
 Power Capacity : 2W max.

Part Number

BL **0605** - **10** **L** **2000** **NA** **□** **/LF**
 ① ② ③ ④ ⑤ ⑥ ⑦ ⑧

① Type	BL : Balun	② Dimensions (L x W)	0.6 x 0.5 mm
③ Balanced Impedance	10 : 100 ohm	④ Material Code	L
⑤ Central Frequency	2000 : 2000MHz	⑥ Specification Code	NA
⑦ Packaging	T: Tape & Reel B: Bulk	⑧ Soldering	/LF=lead-free

Terminal Configuration

< Top View >

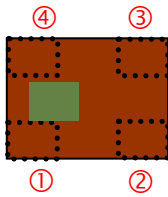

No.	Terminal Name	No.	Terminal Name
①	GND	③	Balanced Port
②	Unbalanced Port	④	Balanced Port

Dimensions and Recommended PC Board Pattern

Unit : mm

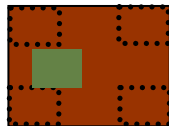

< Top View >

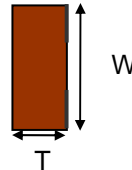

< Side View >

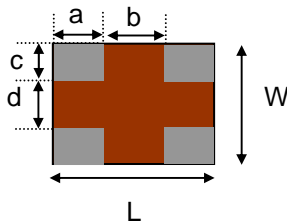

< Bottom View >

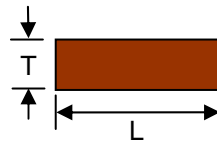

< Side View >

Mark	L	W	T	a	b	c	d
Dimensions	0.65 ± 0.05	0.5 ± 0.05	0.45 max	0.225 +0.1/-0.05	0.2 +0.1/-0.05	0.15 +0.1/-0.05	0.2 +0.1/-0.05

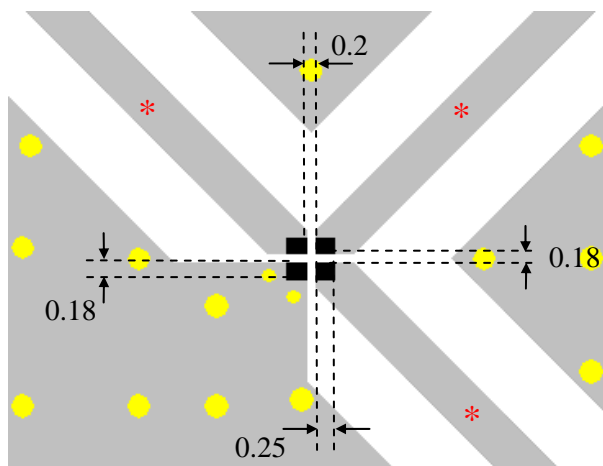

- Solder Resist
- Land
- Through-hole (ϕ 0.2 / 0.35)

* Line width should be designed to match 50 Ω characteristic impedance, depending on PCB material and thickness.

Measuring Diagram

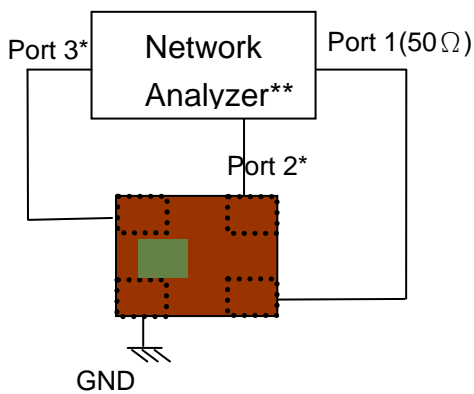

Port 1: Unbalanced Port
Ports 2 and 3: Balanced Port

$$IL = S_{ds21}$$

$$RL = S_{ss11}$$

$$\text{Amp_balance} = \text{dB}(S(2,1)/S(3,1))$$

$$\text{Phase_balance} = \text{Phase}(S(2,1)/S(3,1))$$

*Impedance for ports 2 and 3 = Balanced Impedance/2

**E5071B from Agilent

Typical Electrical Characteristics (T=25°C)

Insertion and Return Loss

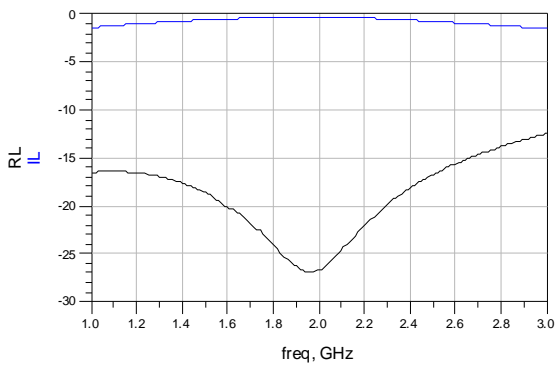

Amplitude and Phase Balance

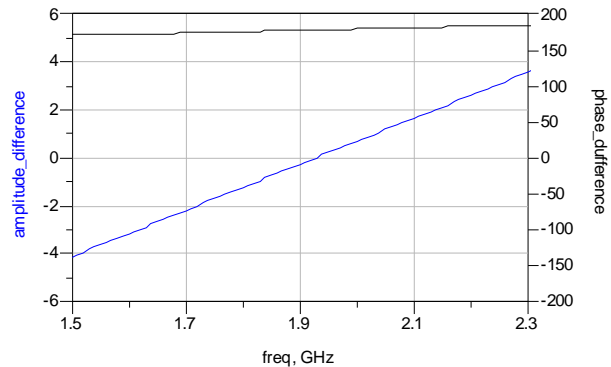

Notes

❖ The contents of this data sheet are subject to change without notice. Please confirm the specifications and delivery conditions when placing your order.

Taping Specifications

❖Tape Dimensions (Unit: mm) & Quantity

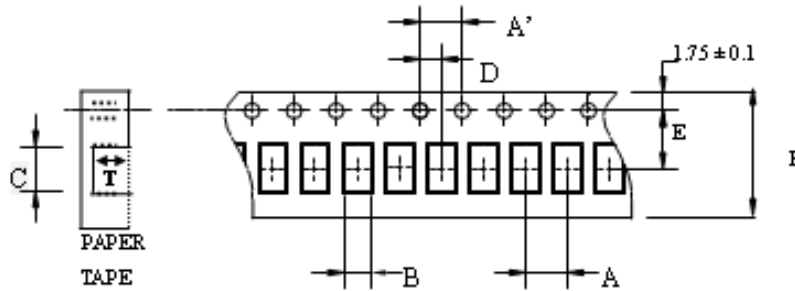

Type	A	A'	B	C	D	E	F	T	Quantity/reel	Tape material
0605	2.0±	4.0±	0.58±	0.78±	2.0±	3.5±	8.0±	0.45±	10,000pcs	Paper
	0.05	0.1	0.03	0.03	0.05	0.05	0.2	0.03		

❖Reel Dimensions (Unit: mm)

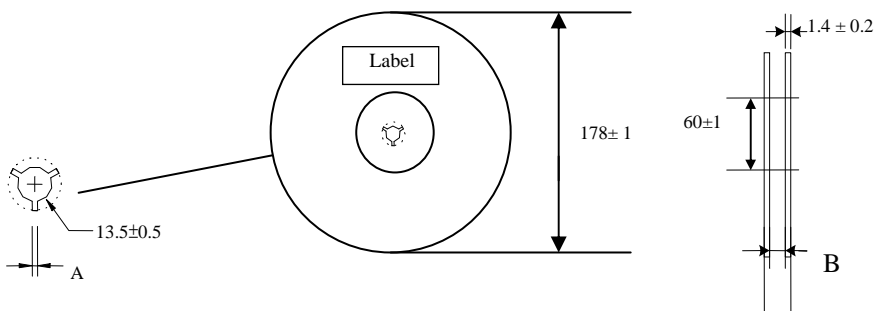

Label: Customer's Name,
ACX P/N, Q'ty, Date,
ACX Corp.

Type	A	B
0605	2.3±0.5	9.0±0.3

❖Leader and Trailer Tape

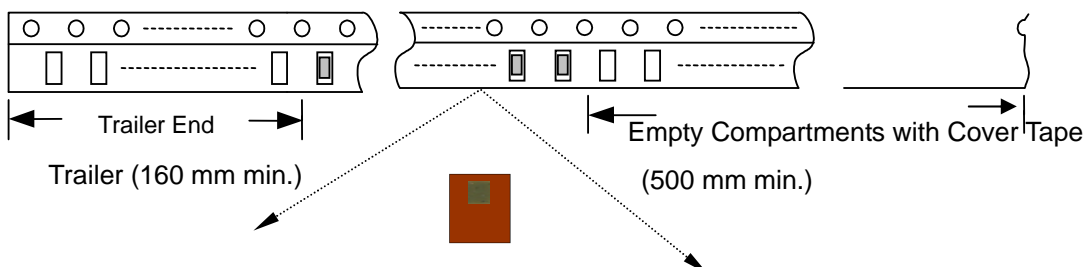

❖ **Peel-off Force**



Peel-off force should be in the range of 0.1 – 0.6 N at a peel-off speed of 300 ± 10 mm/min .

❖ **Storage Conditions**

- (1) Temperature: 5 ~35°C , relative humidity (RH): 45~75%.
- (2) Non-corrosive environment.

Notes

❖ The contents of this data sheet are subject to change without notice. Please confirm the specifications and delivery conditions when placing your order.

Mechanical & Environmental Characteristics

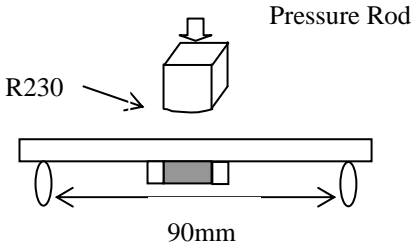
Item	Requirements	Procedure
Solderability	<ol style="list-style-type: none"> No apparent damage More than 75% of the terminal electrode shall be covered with new solder. 	<ol style="list-style-type: none"> Preheat: $120 \pm 5^\circ\text{C}$ Solder: $245 \pm 5^\circ\text{C}$ for 5 ± 1 sec
Soldering strength (Termination Adhesion)	<ol style="list-style-type: none"> 2N minimum 	<ol style="list-style-type: none"> Solder specimen onto test jig. Apply push force at 0.5mm/s until electrode pads are peeled off or ceramic are broken. Pushing force is applied to longitude direction
Deflection (Substrate Bending)	<ol style="list-style-type: none"> No apparent damage Fulfill the electrical specification 	<ol style="list-style-type: none"> Solder specimen onto test jig (FR4, 0.8mm) using the recommend soldering profile. Apply a bending force of 2mm deflection 
Heat/Humidity Resistance	<ol style="list-style-type: none"> No apparent damage Fulfill the electrical specification after test 	<ol style="list-style-type: none"> Temperature: $85 \pm 2^\circ\text{C}$ Humidity: 90% ~ 95% RH Duration: 1000 ± 48hrs Recovery: 1-2hrs
Thermal shock (Temperature Cycle)	<ol style="list-style-type: none"> No apparent damage Fulfill the electrical specification after test 	<ol style="list-style-type: none"> One cycle/step 1 : $125 \pm 5^\circ\text{C}$ for 30 min step 2 : $-40 \pm 5^\circ\text{C}$ for 30 min No of cycles : 100 Recovery: 1-2 hrs
Low Temperature Resistance	<ol style="list-style-type: none"> No apparent damage Fulfill the electrical specification after test 	<ol style="list-style-type: none"> Temperature: $-40 \pm 5^\circ\text{C}$ Duration: 500 ± 24hrs Recovery: 1-2hrs

Soldering Conditions

❖ Typical Soldering Profile for Lead-free Process

Reflow Soldering :

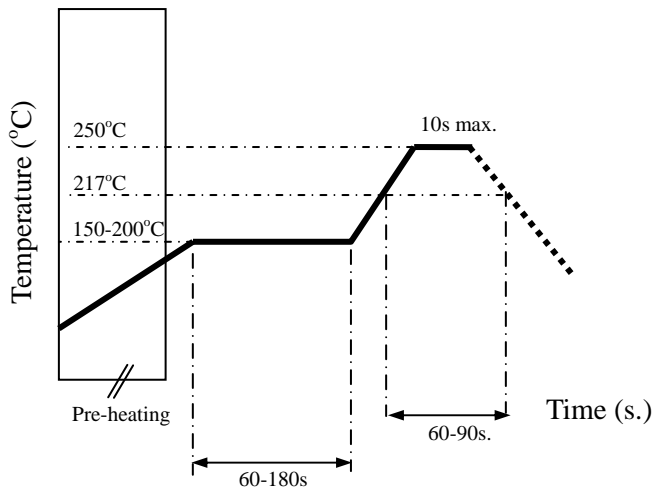

Notes

❖ The contents of this data sheet are subject to change without notice. Please confirm the specifications and delivery conditions when placing your order.

Advanced Ceramic X Corp.

16 Tzu Chiang Road, Hsinchu Industrial District Hsinchu Hsien 303, Taiwan

TEL:886-3-5987008 FAX:886-3-5987001

E-mail: acx@acxc.com.tw

<http://www.acxc.com.tw>