

## N-channel Enhanced mode TO-220F MOSFET

### Features

- High ruggedness
- Low  $R_{DS(ON)}$  (Typ 0.15Ω)@ $V_{GS}=10V$
- Low Gate Charge (Typ 60nC)
- Improved dv/dt Capability
- 100% Avalanche Tested
- Application:LED,Charge,PC Power

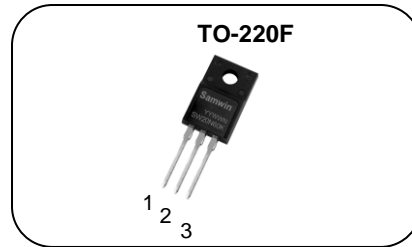

1. Gate 2. Drain 3. Source

$BV_{DSS}$  : 600V

$I_D$  : 20A

$R_{DS(ON)}$  : 0.15Ω

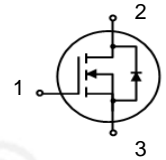

### General Description

This power MOSFET is produced with super junction advanced technology of SAMWIN. This technology enable the power MOSFET to have better characteristics, including fast switching time, low on resistance, low gate charge and especially excellent avalanche characteristics.



### Order Codes

Item	Sales Type	Marking	Package	Packaging
1	SW F 20N60K	SW20N60K	TO-220F	TUBE

### Absolute maximum ratings

Symbol	Parameter	Value	Unit
$V_{DSS}$	Drain to source voltage	600	V
$I_D$	Continuous drain current (@ $T_C=25^\circ C$ )	20*	A
	Continuous drain current (@ $T_C=100^\circ C$ )	12.6*	A
$I_{DM}$	Drain current pulsed (note 1)	80	A
$V_{GS}$	Gate to source voltage	±30	V
$E_{AS}$	Single pulsed avalanche energy (note 2)	500	mJ
$E_{AR}$	Repetitive avalanche energy (note 1)	20	mJ
dv/dt	MOSFET dv/dt ruggedness (@ $V_{DS}=0\sim 400V$ )	30	V/ns
dv/dt	Peak diode recovery dv/dt (note 3)	20	V/ns
$P_D$	Total power dissipation (@ $T_C=25^\circ C$ )	35.9	W
	Derating factor above 25°C	0.3	W/°C
$T_{STG}, T_J$	Operating junction temperature & storage temperature	-55 ~ + 150	°C
$T_L$	Maximum lead temperature for soldering purpose, 1/8 from case for 5 seconds.	300	°C

\*. Drain current is limited by junction temperature.

### Thermal characteristics

Symbol	Parameter	Value	Unit
$R_{thjc}$	Thermal resistance, Junction to case	3.48	°C/W
$R_{thja}$	Thermal resistance, Junction to ambient	47.3	°C/W

## Electrical characteristic ( $T_C = 25^\circ\text{C}$ unless otherwise specified )

Symbol	Parameter	Test conditions	Min.	Typ.	Max.	Unit
<b>Off characteristics</b>						
$BV_{DSS}$	Drain to source breakdown voltage	$V_{GS}=0V, I_D=250\mu A$	600			V
$\Delta BV_{DSS} / \Delta T_J$	Breakdown voltage temperature coefficient	$I_D=250\mu A$ , referenced to $25^\circ\text{C}$		0.64		$V/^\circ\text{C}$
$I_{DSS}$	Drain to source leakage current	$V_{DS}=600V, V_{GS}=0V$			1	$\mu A$
		$V_{DS}=480V, T_C=125^\circ\text{C}$			50	$\mu A$
$I_{GSS}$	Gate to source leakage current, forward	$V_{GS}=30V, V_{DS}=0V$			100	nA
	Gate to source leakage current, reverse	$V_{GS}=-30V, V_{DS}=0V$			-100	nA
<b>On characteristics</b>						
$V_{GS(TH)}$	Gate threshold voltage	$V_{DS}=V_{GS}, I_D=250\mu A$	2		5	V
$R_{DS(ON)}$	Drain to source on state resistance	$V_{GS}=10V, I_D=10A$		0.15	0.18	$\Omega$
$G_{fs}$	Forward transconductance	$V_{DS}=30V, I_D=10A$		14		S
<b>Dynamic characteristics</b>						
$C_{iss}$	Input capacitance	$V_{GS}=0V, V_{DS}=200V, f=1\text{MHz}$		2100		pF
$C_{oss}$	Output capacitance			79		
$C_{rss}$	Reverse transfer capacitance			3.1		
$t_{d(on)}$	Turn on delay time	$V_{DS}=300V, I_D=20A, R_G=25\Omega$ $V_{GS}=0V$ (note 4,5)		28		ns
$t_r$	Rising time			52		
$t_{d(off)}$	Turn off delay time			116		
$t_f$	Fall time			40		
$Q_g$	Total gate charge	$V_{DS}=520V, V_{GS}=10V, I_D=20A$ (note 4,5)		60		nC
$Q_{gs}$	Gate-source charge			17		
$Q_{gd}$	Gate-drain charge			26		

## Source to drain diode ratings characteristics

Symbol	Parameter	Test conditions	Min.	Typ.	Max.	Unit
$I_S$	Continuous source current	Integral reverse p-n Junction diode in the MOSFET			20	A
$I_{SM}$	Pulsed source current				80	A
$V_{SD}$	Diode forward voltage drop.	$I_S=20A, V_{GS}=0V$			1.4	V
$t_{rr}$	Reverse recovery time	$I_S=20A, V_{GS}=0V,$ $di_f/dt=100A/\mu s$		366		ns
$Q_{rr}$	Reverse recovery charge			6.8		$\mu C$

### ※. Notes

1. Repeattive rating : pulse width limited by junction temperature.
2.  $L = 62.5\text{mH}, I_{AS} = 4A, V_{DD} = 50V, R_G = 25\Omega$ , Starting  $T_J = 25^\circ\text{C}$
3.  $I_{SD} \leq 20A, di/dt = 100A/\mu s, V_{DD} \leq BV_{DSS}$ , Starting  $T_J = 25^\circ\text{C}$
4. Pulse Test : Pulse Width  $\leq 300\mu s$ , duty cycle  $\leq 2\%$ .
5. Essentially independent of operating temperature.

**Fig. 1. On-state characteristics**

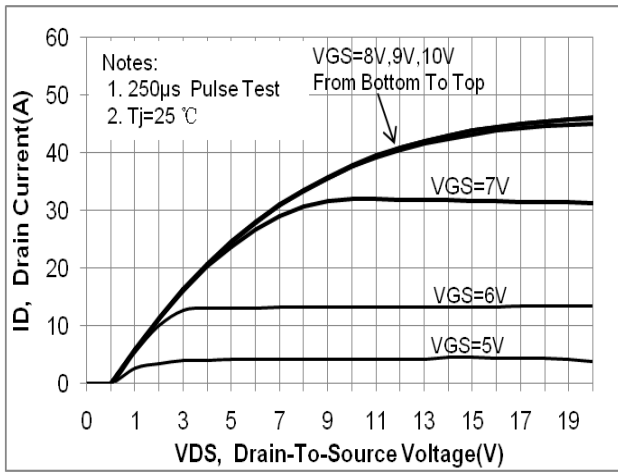

**Fig. 2. On-resistance variation vs. drain current and gate voltage**

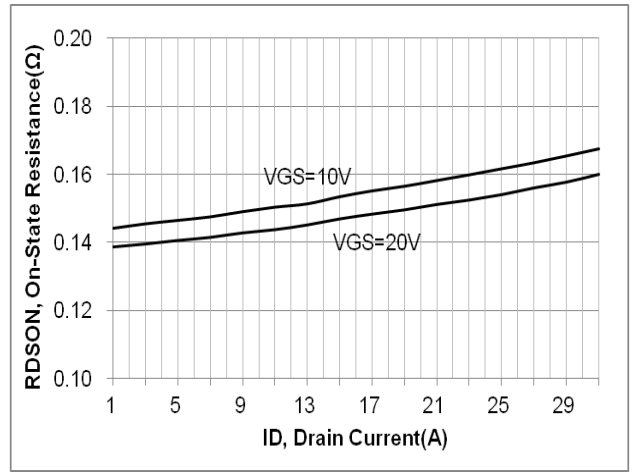

**Fig. 3. Gate charge characteristics**

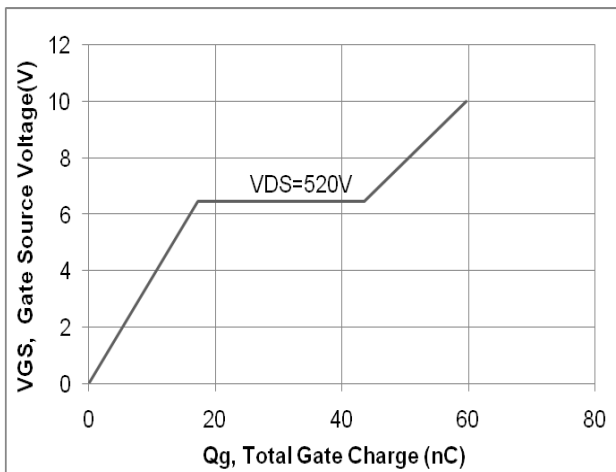

**Fig. 4. On state current vs. diode forward voltage**

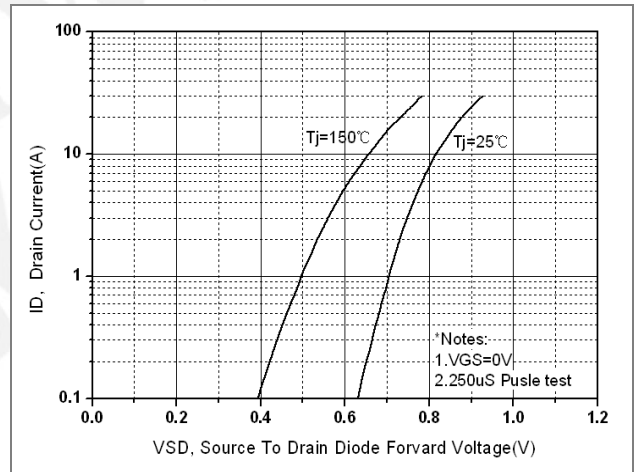

**Fig 5. Breakdown Voltage Variation vs. Junction Temperature**

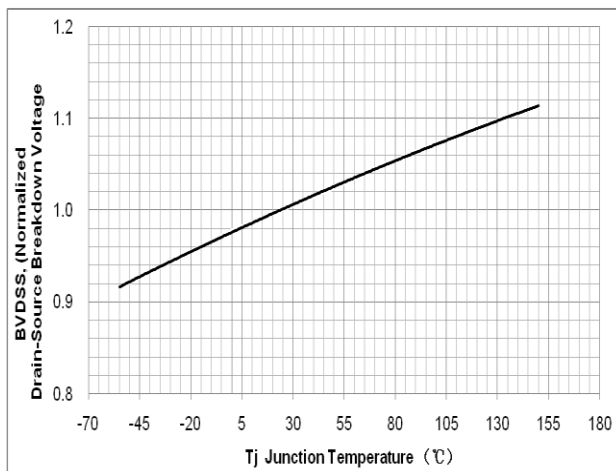

**Fig. 6. On resistance variation vs. junction temperature**

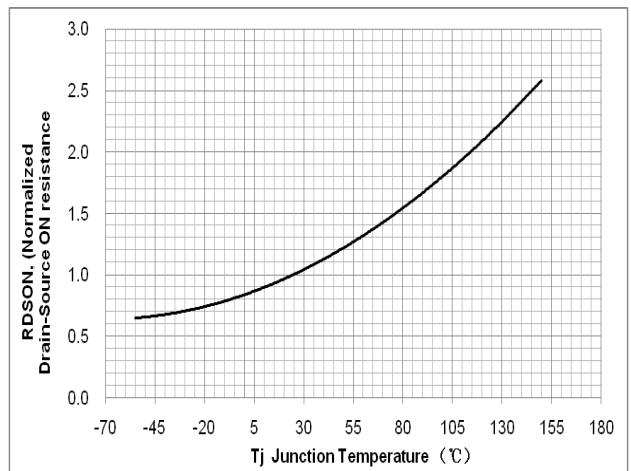

Fig. 7. Maximum safe operating area

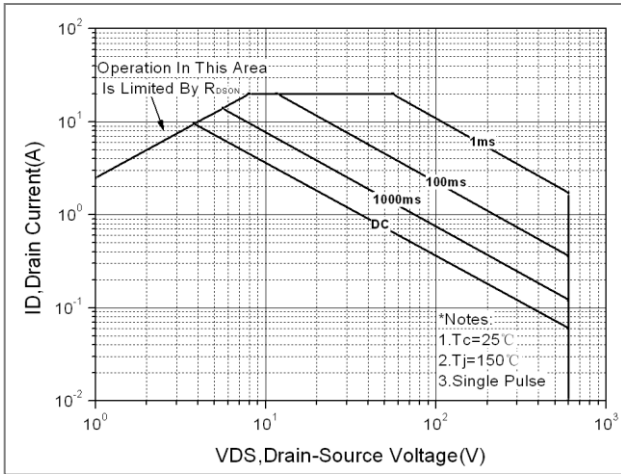

Fig. 8. Capacitance Characteristics

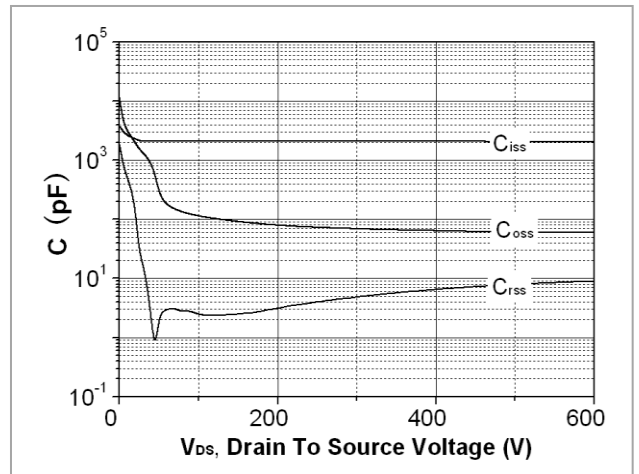

Fig. 9. Transient thermal response curve

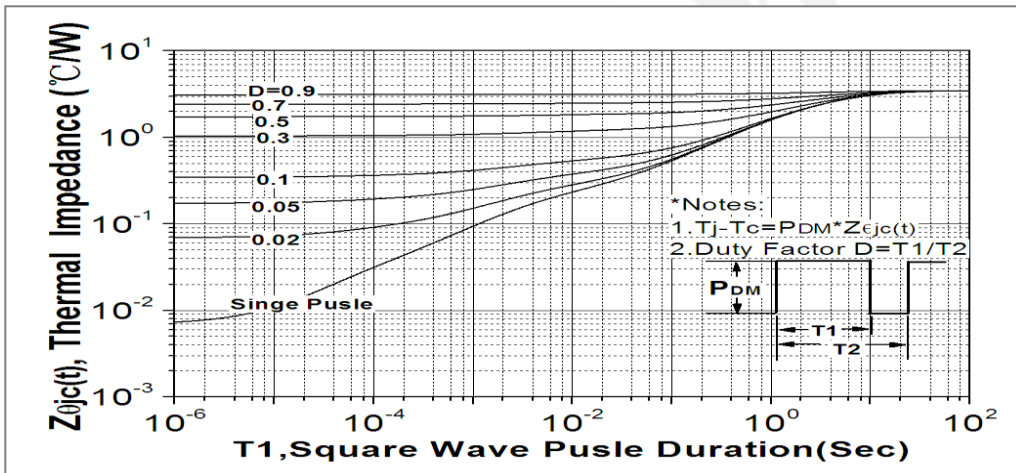
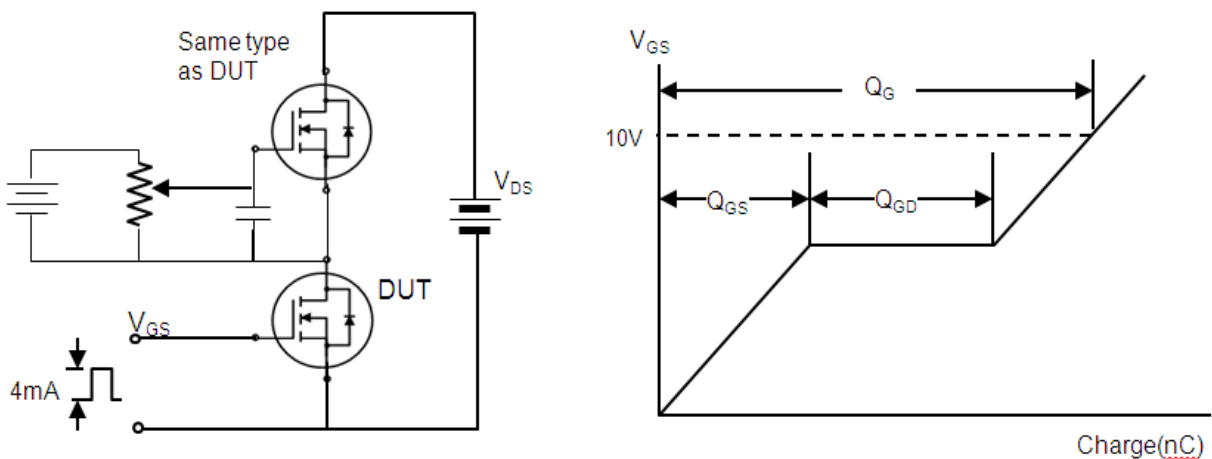
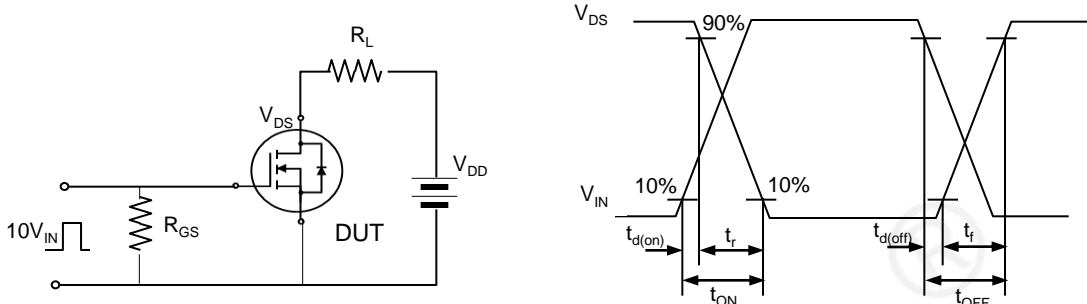

Fig. 10. Gate charge test circuit & waveform



**Fig. 11. Switching time test circuit & waveform**



**Fig. 12. Unclamped Inductive switching test circuit & waveform**

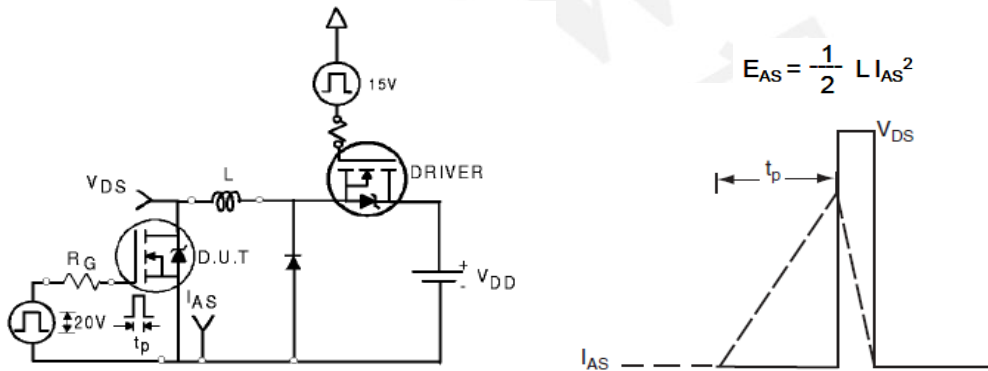

**Fig. 13. Peak diode recovery dv/dt test circuit & waveform**

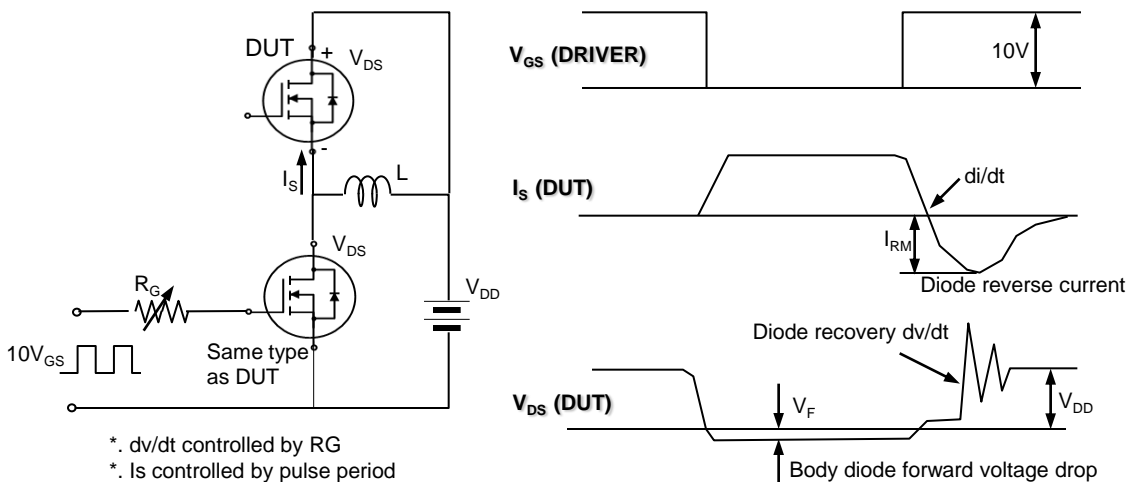

Samwin<sup>®</sup>  
内部保密

### DISCLAIMER

\* All the data & curve in this document was tested in XI' AN SEMIPOWER TESTING & APPLICATION CENTER.

\* This product has passed the PCT,TC,HTRB,HTGB,HAST,PC and Solderdunk reliability test .

\* Qualification standards can also be found on the Web site (<http://www.semipower.com.cn>)

\* Suggestions for improvement are appreciated, Please send your suggestions to [samwin@samwinsemi.com](mailto:samwin@samwinsemi.com)