

 HOLLYLAND(CHINA) ELECTRONICS TECHNOLOGY CORPORATION LTD. HOLLYLAND(XIAMEN) TECHNOLOGY CORPORATION LTD.	<b>PRODUCT SPECIFICATION</b>	ISSUED DATE:	2018/04/24
	25F RoHS & Pb-Free 系列 25F RoHS & Pb-Free SERIES	REV. No.:	A06
		DOC. No.:	HLD-PSI-8166
		PAGE:	Page 1 of 9

制定 PREPARED BY	研发部 2018-4-20 叶小坤	审核 CHECKED BY	研发部 2018-4-20 陶家山	批准 APPROVED BY	副总经理 2018-4-20 赖文辉
-------------------	-------------------------	------------------	-------------------------	-------------------	--------------------------

## 1. 适用范围 SCOPE

本规格书适用于公司生产并获得 UR、cUR、CQC、TUV 认证的 25F RoHS & Pb-Free 系列 HOLLY® 商标的超小型保险丝管。

This specification defines the technical requirements of Surface Mount type 25F RoHS & Pb-Free series with HOLLY® brand, which has been approved by UR、cUR、CQC、TUV.

产品部件号为:            型号                    额定电流                    额定电压  
 Construction of Part No.: Type                    Rated Current                    Rated Voltage  
 例如 For Example: 25F                            0500                                H

额定电压 Rated Voltage: H---250V AC (200mA -10A)  
                                   L1---125V DC/AC (200mA -15A)  
                                   L2--- 65V DC (12A -15A)

产品部件号 PART NUMBER

产品部件号 Part Number	额定电流 Rated Current	标识 Marking	额定电压 Rated Voltage	电阻 Nominal Resistance (Ohms)	参考熔化 I <sup>2</sup> t Normal Melting I <sup>2</sup> t(A <sup>2</sup> Sec.) (t=8ms)
25F-0200H/L1	200mA	0.2	250V AC 125V DC/AC	0.550	0.008
25F-0250H/L1	250mA	0.25		0.530	0.012
25F-0315H/L1	315mA	0.315		0.340	0.031
25F-0375H/L1	375mA	0.375		0.240	0.067
25F-0400H/L1	400mA	0.4		0.210	0.073
25F-0500H/L1	500mA	0.5		0.190	0.100
25F-0630H/L1	630mA	0.63		0.120	0.188
25F-0750H/L1	750mA	0.75		0.097	0.315
25F-0800H/L1	800mA	0.8		0.088	0.335
25F-010H/L1	1A	1		0.085	0.340
25F-012H/L1	1.2A	1.2		0.070	0.490
25F-013H/L1	1.25A	1.25		0.067	0.520
25F-015H/L1	1.5A	1.5		0.054	0.930
25F-016H/L1	1.6A	1.6		0.052	0.970
25F-020H/L1	2A	2		0.037	1.92
25F-025H/L1	2.5A	2.5		0.030	3.38
25F-030H/L1	3A	3		0.025	3.95
25F-032H/L1	3.15A	3.15		0.0235	4.01
25F-035H/L1	3.5A	3.5		0.0205	5.26
25F-040H/L1	4A	4		0.0190	7.81
25F-050H/L1	5A	5	0.0145	12.22	
25F-060H/L1	6A	6	0.0105	6.22	
25F-063H/L1	6.3A	6.3	0.0100	7.01	
25F-070H/L1	7A	7	0.0086	8.36	
25F-080H/L1	8A	8	0.0075	12.81	
25F-100H/L1	10A	10	0.0060	19.03	
25F-120L1/L2	12A	12	65V DC	0.00425	35.62
25F-150L1/L2	15A	15	125V DC/AC	0.00335	70.997

 HOLLYLAND(CHINA) ELECTRONICS TECHNOLOGY CORPORATION LTD. HOLLYLAND(XIAMEN) TECHNOLOGY CORPORATION LTD.	<b>PRODUCT SPECIFICATION</b>	ISSUED DATE:	2018/04/24
	25F RoHS & Pb-Free 系列 25F RoHS & Pb-Free SERIES	REV. No.:	A06
		DOC. No.:	HLD-PSI-8166
		PAGE:	Page 2 of 9

阻抗范围: 参考电阻±25% The range of resistance: Reference Resistance ±25%

型号规格: 型号 特性符号 额定电流 分断能力符号 额定电压  
MODEL DETAIL: Type Characteristic Symbol Rated Current Breaking Capacity Symbol Rated Voltage  
例如/ Example: 25F F 2A L 250V

\*特性符号/ Characteristic Symbol: F - 速断型/ Quick-Acting, 分断能力符号/ Breaking Capacity Symbol: L - 低分断能力/ Low Breaking Capacity.

## 2. 相关标准及认证情况 APPLICABLE STANDARDS & APPROVED DETAILS

### 2.1 相关标准 APPLICABLE STANDARDS

UL 248-1, UL 248-14, CSA C22.2 No. 248.1-00, CSA C22.2 No. 248.14-00, IEC 60127, GB 9364.

### 2.2 认证情况 APPROVED DETAILS

额定电压 RATED VOLTAGE		250V AC	125V DC/AC	65V DC
UR & cUR	认证范围 APPROVED RANGE	200mA - 10A	200mA - 15A	12A -15A
	认证号码 CERT. No.	E156471		
CQC	认证范围 APPROVED RANGE	1A-5A	1A-5A	
	认证号码 CERT. No.	CQC15012121528	CQC15012124609	
TUV	认证范围 APPROVED RANGE	1A-5A	1A-5A	
	认证号码 CERT. No.	R50316253	R50316248	

## 3. 公司地址: 中国福建省厦门市翔安区航山东二路 829 号

ADDRESS: 829 Fangshan East 2nd Road, Xiang'an, Xiamen, China

## 4. 外形与结构 DIMENSION & CONSTRUCTION

### 4.1 外形尺寸 DIMENSION: 单位 Unit: mm (inch)

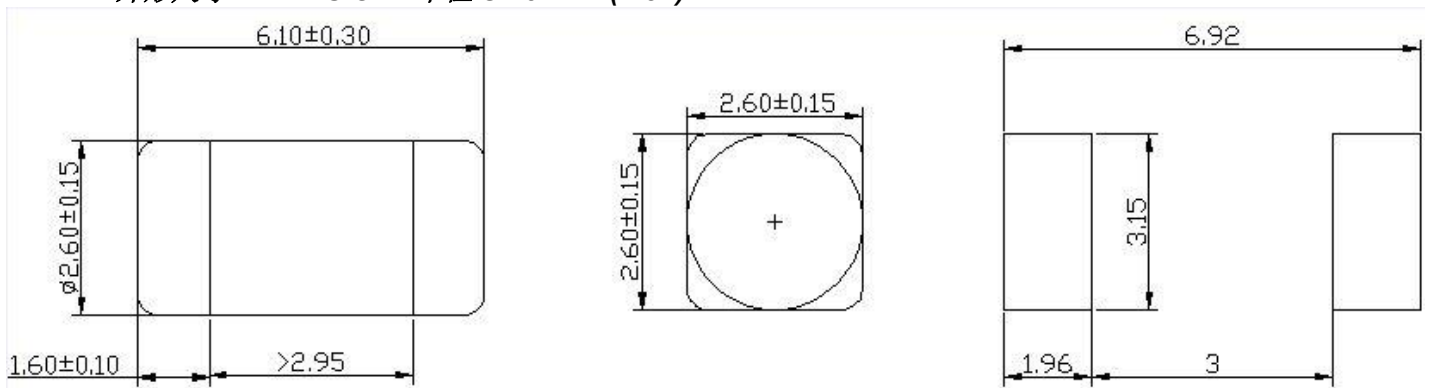

Recommended pad layout

 HOLLYLAND(CHINA) ELECTRONICS TECHNOLOGY CORPORATION LTD. HOLLYLAND(XIAMEN) TECHNOLOGY CORPORATION LTD.	<b>PRODUCT SPECIFICATION</b>	ISSUED DATE:	2018/04/24
	25F RoHS & Pb-Free 系列 25F RoHS & Pb-Free SERIES	REV. No.:	A06
		DOC. No.:	HLD-PSI-8166
		PAGE:	Page 3 of 9

#### 4.2 原材料 MATERIALS

编号 No.	部 件 PARTS	材 料 MATERIALS	备 注 REMARK
1	焊锡 Solder	无铅焊锡 Pb Free Solder	符合 RoHS & Pb-Free 指令要求 RoHS & Pb-Free Compliant
2	可熔体 Fusible Element	金属丝 Alloy	
3	管体 Tube	陶瓷管 Ceramic Tube	
4	外帽 External Cap	黄铜镀镍 $\geq 1\mu\text{m}$ , 镀锡 $\geq 1\mu\text{m}$ No less than $1\mu\text{m}$ Ni plated Brass, then no less than $1\mu\text{m}$ Sn plated	
5	内帽 Inner Cap	黄铜 Brass	

#### 4.3 陶瓷管 CERAMIC TUBE

陶瓷管必须无缺陷如破裂、缺损、污染。

The ceramic tube shall have no defects such as crack, injury and contamination.

#### 4.4 铜帽 CAP

铜帽应被牢固固定在管体两端，以保证在未损坏熔断体时，铜帽不能被卸下。铜帽表面镀层应牢固不易脱落。  
Cap should be firmly attached to the both ends of the tube so that it is not possible to remove them without damaging the fuse itself. The cap plated layer is not easy to fall off.

### 5. 机械特性 MECHANICAL PERFORMANCES

保险丝应安装在 1.6mm 厚的覆铜箔环氧玻璃布层压板的试验板上，将试验板装有保险丝的一面向下，放在弯曲夹具上，试验板以 1mm/s 的速率弯曲到 1mm。试验板应允许从弯曲位置恢复过来，并从试验夹具上拆下。试验结束后，保险丝端部仍应固定牢固。

The fuse-links shall be mounted on the test board, which is made of epoxide woven glass fabric copper-clad laminated 1.6mm thickness sheet. The test board, with the fuse-links on the underside, shall be placed in the bending jig. The board shall then be bent by 1 mm at the rate of 1 mm/s. The test board shall be allowed to recover from the bent position, and then be removed from the test jig. After the test, the terminals shall remain firmly attached.

### 6. 电气特性 ELECTRICAL PERFORMANCES

#### 6.1 测试条件 TEST CONDITIONS

A. 全部测试条件都应在环境温度  $25 \pm 5^\circ\text{C}$  条件下进行，在此期间温度变化不允许达到  $5^\circ\text{C}$  和到极限范围。

All electrical tests shall be conducted at an ambient temperature of  $25 \pm 5^\circ\text{C}$ . The ambient temperature shall not vary more than  $5^\circ\text{C}$  during the test, and must be within these limits.

B. 当两个或两个以上的保险丝串联测试时，保险丝管座的放置位置应保证使任何两个进行测试的保险丝所用的保险丝管座之间的间隙不能小于 50mm。将保险丝管座连在一起的导线以及将保险丝管座与测试电路直接相连的任何电流测试装置相连，及其与电源相连的连接线为带绝缘的铜导线。每根导线的长度应为 250mm，而且该导线的横截面积约为  $1\text{mm}^2$ 。

 HOLLYLAND(CHINA) ELECTRONICS TECHNOLOGY CORPORATION LTD. HOLLYLAND(XIAMEN) TECHNOLOGY CORPORATION LTD.	<b>PRODUCT SPECIFICATION</b>	ISSUED DATE:	2018/04/24
	25F RoHS & Pb-Free 系列 25F RoHS & Pb-Free SERIES	REV. No.:	A06
		DOC. No.:	HLD-PSI-8166
		PAGE:	Page 4 of 9

When two or more fuse-links are tested in series, the test fuse-bases shall be located so that there will be a spacing of not less than 50mm between any two fuse-links under test. The conducting wire connecting the test fuse-bases together, and the one connecting the test fuse-bases to any current measuring devices connected directly to the test circuit and the source of supply, shall be insulated copper wire. The length of each conducting wire shall be 250 mm, and the cross-sectional area of the wire shall be approximately 1 mm<sup>2</sup>.

#### 6.2 负载能力测试 CURRENT-CARRYING CAPACITY TEST

当保险丝通以 100%额定电流的条件下进行测试时，在 4 小时内电路不应断开，保险丝不被电流熔化，管壳不破裂和烧焦。

When a fuse is carrying 100% of rated current for continuing 4 hours, no open circuit, melt fusible element, or ruptured tube shall occur in any manner during this test.

#### 6.3 温度上升试验 TEMPERATURE RISING TEST

当保险丝通以 100%额定电流的条件下进行测试时，在达到热量平衡后，测量保险丝表面的温度，保险丝表面的温度上升必须等于或低于 75℃。

注：温度上升 = 保险丝表面的温度 - 环境温度

Measure the temperature of the surface of the fuse under the 100% of rated current, when the thermal equilibrium reaches. The temperature rise on the surface of each fuse shall be 75℃ or less.

Note: Temperature Rising = Fuse temperature - Ambient temperature

#### 6.4 预飞弧时间/电流特性 PRE-ARCING TIME / CURRENT CHARACTERISTICS

当保险丝通以下表规定的电流时，其熔断时间必须符合下表的要求，且铜帽不能飞脱、陶瓷管不应破裂、损坏。  
When the current in the following table is passing the fuse, its opening time must be in accordance with the requirements in the following table. Moreover, no damage of the fuse-tube or shattering of the cap shall occur.

%额定电流 % of Rated Current	额定电流 Rated Current	熔断时间 Opening Time
100%	200mA-15A	最快 4 小时 4 hours Min.
125%	1A-5A	最快 1 小时 1 hours Min.
200%	200mA-10A	最慢 5 秒 5 seconds Max.
200%	12A-15A	最慢 20 秒 20 seconds Max.
1000%	1A-5A	0.001-0.01Sec.

#### 6.5 分断能力/绝缘电阻 INTERRUPTING RATING / INSULATION RESISTANCE

这些型号的保险丝的分断能力应能达到下表规定的相应的各种安全认证的分断能力要求。保险丝分断电路后，保险丝管不应破裂、铜帽飞脱、且铜帽两端的绝缘电阻不小于 0.1MΩ @ 500V DC。

The interrupting rating should reach the interrupting current rating given in the following table. And after this test, there should be no damage of the fuse-tube or shattering of the caps. After this test, the insulation resistance between the end caps shall be not less than 0.1MΩ @ 500V DC.

 HOLLYLAND(CHINA) ELECTRONICS TECHNOLOGY CORPORATION LTD. HOLLYLAND(XIAMEN) TECHNOLOGY CORPORATION LTD.	<b>PRODUCT SPECIFICATION</b>	ISSUED DATE:	2018/04/24
	25F RoHS & Pb-Free 系列 25F RoHS & Pb-Free SERIES	REV. No.:	A06
		DOC. No.:	HLD-PSI-8166
		PAGE:	Page 5 of 9

UR& cUR		CQC/TUV	
额定电流 RATED CURRENT	分断能力 INTERRUPTING RATING	额定电流 RATED CURRENT	分断能力 INTERRUPTING RATING
200mA- 10A	50A@250V AC 100A@125V DC/AC	1A-5A	100A@250V AC 50A@125V DC/AC
12A-15A	50A@125V DC/AC 100A@65V DC		

#### 6.6 电阻测试 COLD RESISTANCE TEST

环境温度为  $25 \pm 5^{\circ}\text{C}$ ，测试电流不大于保险丝额定电流的 10%。

Test current less than or equal to 10% of rated current to the fuse for cold resistance test at an ambient temperature of  $25 \pm 5^{\circ}\text{C}$ .

#### 6.7 焊接参数 SOLDERING PARAMETERS

- 1) 红外线回流焊 Infrared Reflow soldering --- $240^{\circ}\text{C}$ 最高，最大 10 秒  $240^{\circ}\text{C}$  Maximum, 10 seconds Maximum;
- 2) 手工焊 Manual soldering --- $350^{\circ}\text{C}$ 最高，最大 5 秒  $350^{\circ}\text{C}$  Maximum, 5 seconds Maximum.

焊接烙铁尖端不应该直接与保险丝端部接触 Soldering Iron shall be used and its tip shall not contact the fuse terminals directly.

#### 6.8 环境温度对负载能力的影响 AMBIENT TEMPERATURE EFFECT ON CURRENT-CARRYING CAPACITY

负载能力修正表  
Chart of Correction Factor

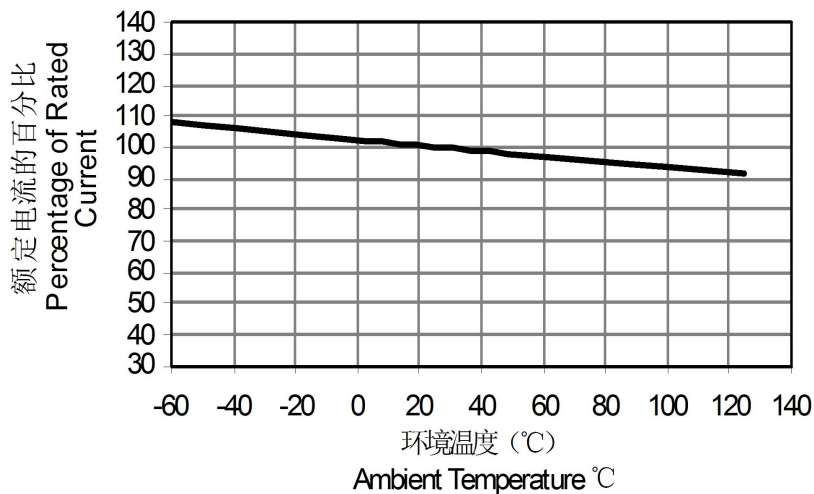



HOLLYLAND(CHINA) ELECTRONICS  
TECHNOLOGY CORPORATION LTD.  
HOLLYLAND(XIAMEN) TECHNOLOGY  
CORPORATION LTD.

### PRODUCT SPECIFICATION

25F RoHS & Pb-Free 系列  
25F RoHS & Pb-Free SERIES

ISSUED DATE:  
REV. No.:  
DOC. No.:  
PAGE:

2018/04/24  
A06  
HLD-PSI-8166  
Page 6 of 9

### 6.9 平均 I-T 特性曲线图(仅供参考) THE AVERAGE I-T CHARACTERISTICS CURVE (For Reference Only)

25F RoHS & Pb-Free 平均 I-T 特性曲线图(仅供参考)  
25F RoHS & Pb-Free I-T CHARACTERISTICS CURVE  
(FOR REFERENCE ONLY)

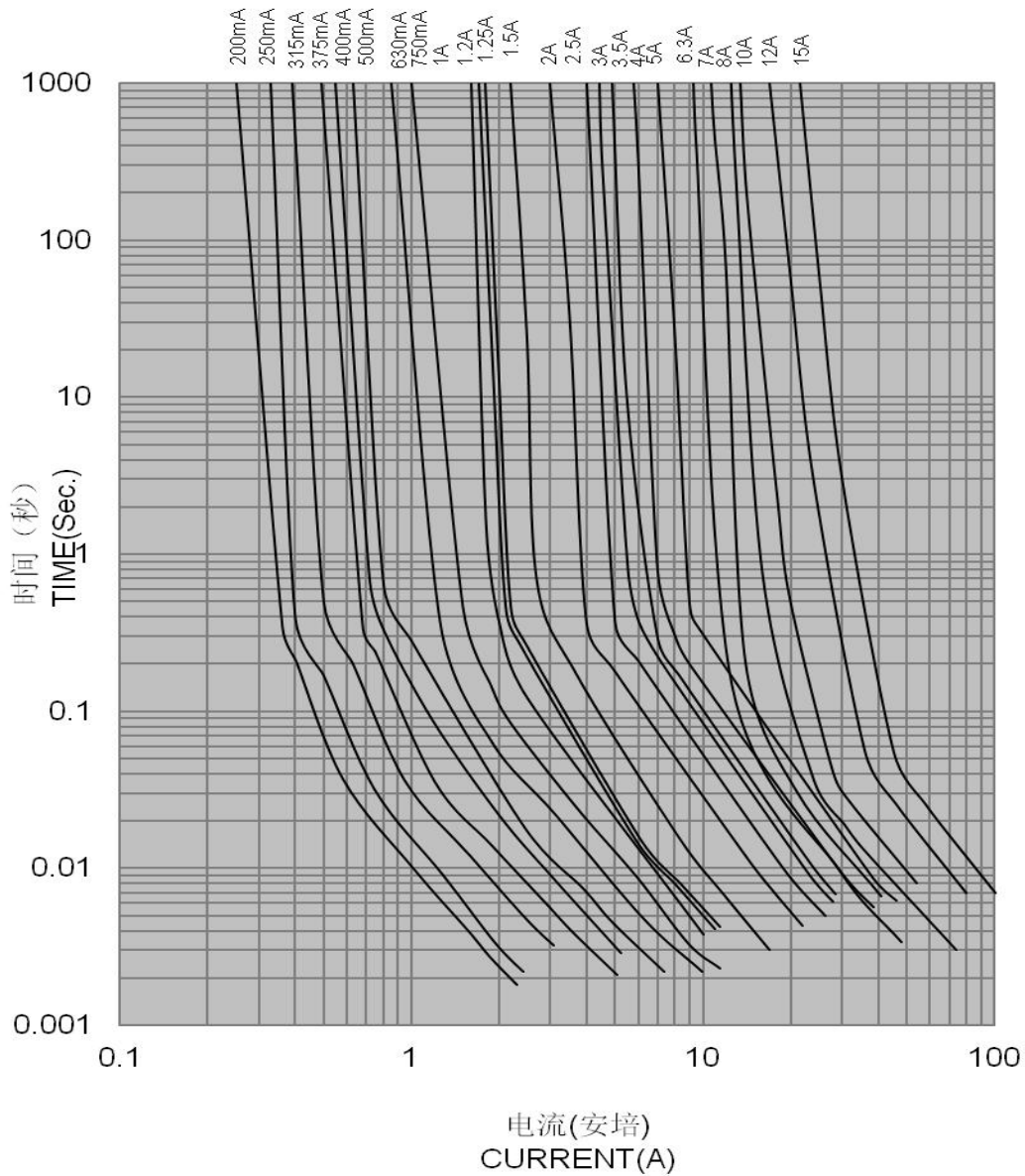



HOLLYLAND(CHINA) ELECTRONICS  
TECHNOLOGY CORPORATION LTD.  
HOLLYLAND(XIAMEN) TECHNOLOGY  
CORPORATION LTD.

**PRODUCT SPECIFICATION**

25F RoHS & Pb-Free 系列  
25F RoHS & Pb-Free SERIES

ISSUED DATE:  
REV. No.:  
DOC. No.:  
PAGE:

2018/04/24  
A06  
HLD-PSI-8166  
Page 7 of 9

6.10 平均 I<sup>2</sup>T-T 特性曲线图((仅供参考) THE AVERAGE I<sup>2</sup>T-T CHARACTERISTICS CURVE (For Reference Only)

25F RoHS & Pb-Free 平均 I<sup>2</sup>T-T 特性曲线图(仅供参考)  
25F RoHS & Pb-Free I<sup>2</sup>T-T CHARACTERISTICS CURVE  
(FOR REFERENCE ONLY)

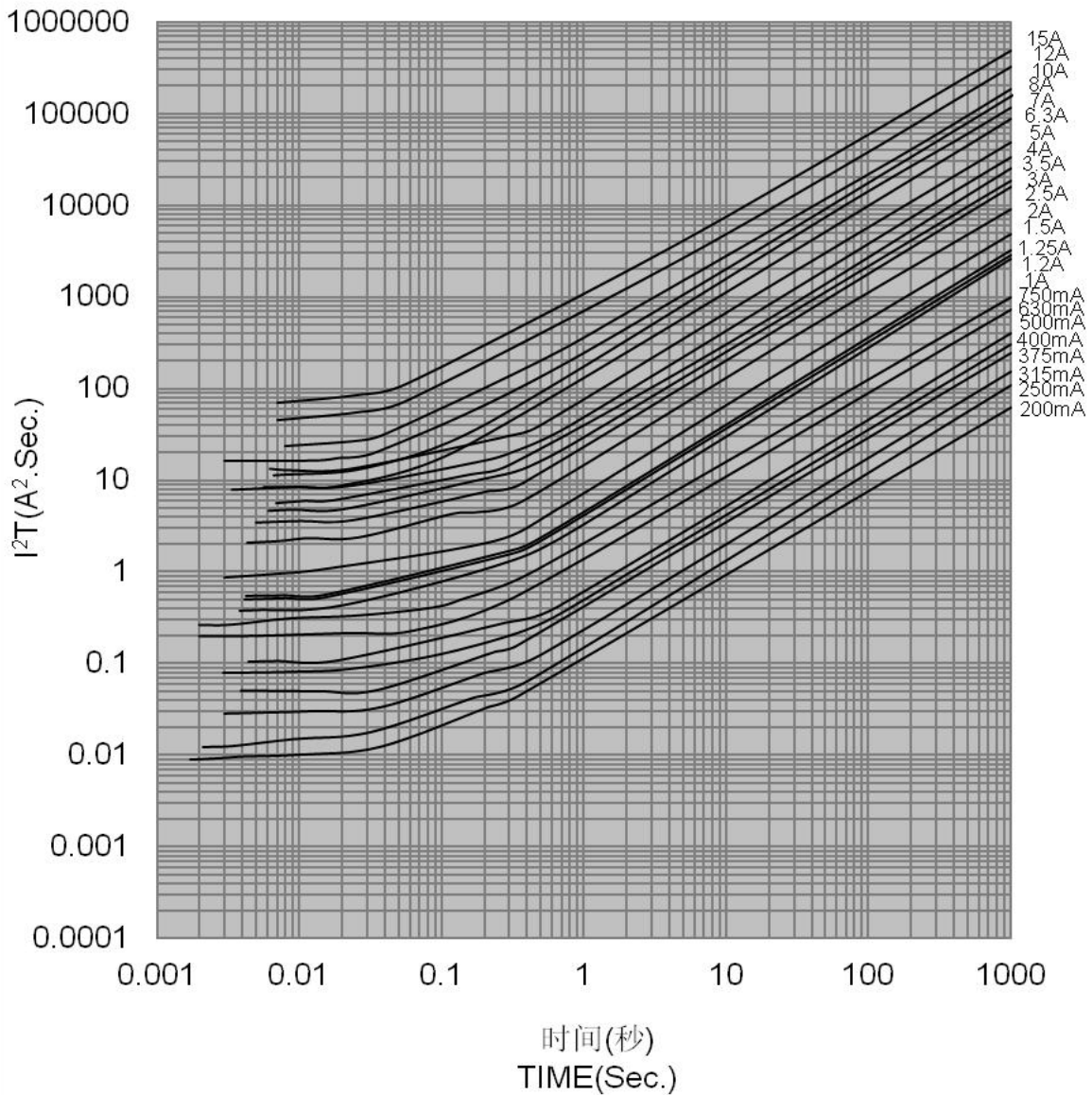

 HOLLYLAND(CHINA) ELECTRONICS TECHNOLOGY CORPORATION LTD. HOLLYLAND(XIAMEN) TECHNOLOGY CORPORATION LTD.	<b>PRODUCT SPECIFICATION</b>	ISSUED DATE:	2018/04/24
	25F RoHS & Pb-Free 系列 25F RoHS & Pb-Free SERIES	REV. No.:	A06
		DOC. No.:	HLD-PSI-8166
		PAGE:	Page 8 of 9

## 7. 产品标志 MARKINGS

7.1 保险丝管表面印有相应的标志，标志应易于看清。



The relevant markings shall be marked on the ceramic tube of the fuse and shall be easily visible.

7.2 每个保险丝应标有下列标记：

The markings for every fuse shall be prescribed as below according to the types:

1) 额定电流 Rated Current

备注：商标、额定电压、安全认证标志(    )和型号名称在包装标签上标识。

Note: The Trademark, Rated Voltage, Safety Approval Logo (    ) and Type should be marked on the packing label.

## 8. 包装要求 PACKING DETAILS

参照产品包装编带标准 EIA-481-D。 Embossed Carrier taping and Reel packing according to EIA-481-D

8.1 编带尺寸 Tape Dimensions:

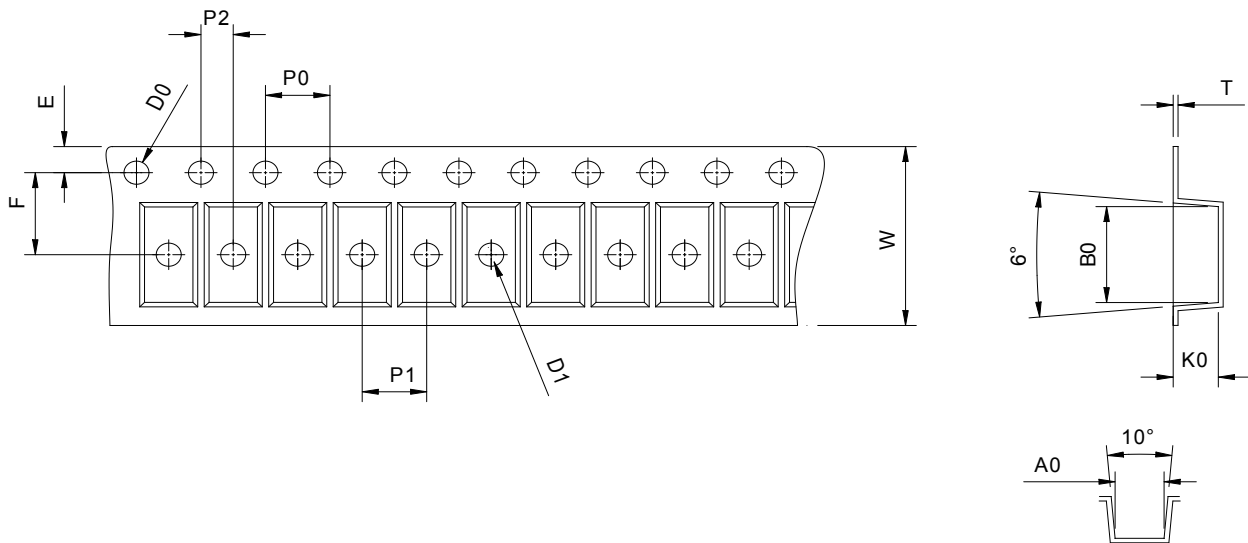

ITEM	A0	B0	K0	W	E	F	P0	P1	P2	D0	D1	T
Dimensions	2.80	6.45	2.75	12.0	1.75	5.50	4.0	4.0	2.0	1.50	1.50	0.25
Tolerance	±0.10	±0.10	±0.10	±0.15	±0.10	±0.05	±0.10	±0.10	±0.05	±0.10	±0.10	±0.05

8.2 送料间距 Feeding pitch: 4mm

8.3 卷盘尺寸 Reel Dimensions:

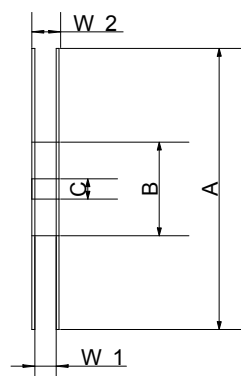
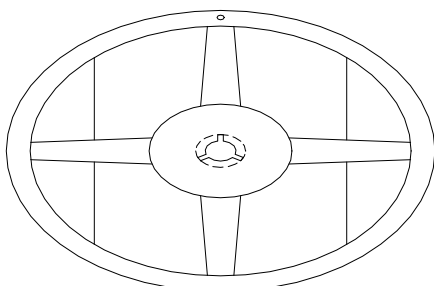





HOLLYLAND(CHINA) ELECTRONICS  
TECHNOLOGY CORPORATION LTD.  
HOLLYLAND(XIAMEN) TECHNOLOGY  
CORPORATION LTD.

**PRODUCT SPECIFICATION**

25F RoHS & Pb-Free 系列  
25F RoHS & Pb-Free SERIES

ISSUED DATE:  
REV. No.:  
DOC. No.:  
PAGE:

2018/04/24  
A06  
HLD-PSI-8166  
Page 9 of 9

ITEM	A	B	C	W <sub>1</sub>	W <sub>2</sub>
Dimensions	178±2.0	60 Min.	13+0.5/-0.2	13+1.0/-0.0	15.4±1.0

8.4 每卷 1,000 只保险丝 1,000EA fuses / reel

8.5 外盒尺寸 Box Dimensions: 长 L\*宽 W\*高 H=180±2\*180±2\*18±1mm

9. 环境和物理性能 ENVIRONMENTAL AND PHYSICAL PERFORMANCES

9.1 工作温度 Operating Temperature: -55℃~125℃.

9.2 储存温度 Storing Temperature: -55℃~85℃.

10. 信赖性试验 RELIABILITY TEST

项目 Item	试验条件 Test Conditions
冲击 Shock	军用标准-202, 方法 213, 测试条件 I, (峰值加速度 100G's, 持续 6ms) MIL-STD-202, Method 213, Test Condition I (100G's peak for 6ms)
振动 Vibration	军用标准-202, 方法 201, (10-55-10 赫兹/分钟, 总振幅 0.06 英寸, X, Y, Z 各方向各 2 小时, 共 6 小时) MIL-STD-202, Method 201(10-55-10Hz / minute, 0.06 inches total excursion in each of 3 mutually perpendicular directions for two hours)
盐雾试验 Salt Atmosphere	军用标准-202, 方法 101, 测试条件 B (48 小时) MIL-STD -202, Method 101, Test Condition B (48 hours)
热冲击 Thermal Shock	军用标准-202, 方法 107, 测试条件 B (-65℃ to 125℃) MIL-STD-202, Method 107, Test Condition B (-65℃ to 125℃)
耐湿性 Moisture Resistance	军用标准-202, 方法 106, (湿度: 90% - 98%R.H., 温度: 65℃) MIL-STD-202, Method 106 (90% to 98%R.H. at 65℃)
可焊性 Solderability	军用标准-202, 方法 208 MIL-STD-202, Method 208
耐焊接热性 Resistance to Soldering Heat	军用标准-202, 方法 210, 测试条件 K, (红外线回流焊: 240℃最大, 最大 10 秒, 超过 95%被焊锡覆盖) MIL-STD-202, Method 210, Test Condition K (Infrared Reflow soldering max. at 240℃ max.for 10s, more than 95% coverage by solder)
绝缘电阻 Insulation Resistance	军用标准-202, 方法302, 测试条件B, (熔断后, 0.1MΩ, 最小) MIL-STD-202, Method 302, Test Condition B (after opening, 0.1MΩ minimum)

 HOLLYLAND(CHINA) ELECTRONICS TECHNOLOGY CORPORATION LTD. HOLLYLAND(XIAMEN) TECHNOLOGY CORPORATION LTD.	<b>PRODUCT SPECIFICATION</b>	ISSUED DATE: 2018/04/24 REV. No.: A06 DOC. No.: HLD-PSI-8166 PAGE: Page 10 of 9
	25F RoHS & Pb-Free 系列 25F RoHS & Pb-Free SERIES	

附件：版本变更记录

文件名称及编号：25T RoHS & Pb-Free 系列（文件编号：HLD-PSI-8167）

注：版本变更记录仅公司内部查阅使用，不对公司以外人员公开。

修改日期	版本	条款	变更内容	备注
2017-5-24	A04	8	1. 修改编带尺寸	
		6.7	1. 回流焊参数由原来 260℃ 最大 30 秒改为 250℃ 最大 10 秒	
2017-8-4	A05	6.7	1. 回流焊参数由原来 250℃ 最大 30 秒改为 240℃ 最大 10 秒	
2018-4-20	A06	4.1	1. 更改外形尺寸由 1.50±0.20 改为 1.60±0.10 2. 更换公司抬头增加电路保护	