

Description

The GT1003A uses advanced trench technology and design to provide excellent $R_{DS(ON)}$, low gate charge. This device is suitable for use in high frequency Synchronous-recification application.

General Features

V_{DSS}	$R_{DS(ON)}$ @ 10V (Typ)	I_D
100V	115m Ω	7 A

- High density cell design for ultra low $R_{DS(ON)}$
- RoHS Compliant
- Excellent package for good heat dissipation

Application

- Consumer electronic power supply
- Isolated DC/DC converter
- Motor control

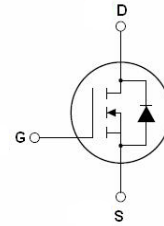

Schematic Diagram

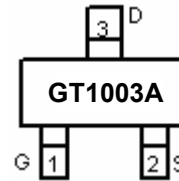

Marking and Pin Assignment



SOT-23-3

Ordering Information

Part Number	Marking	Case	Packaging
GT1003A	GT1003A	SOT-23-3L	3000pcs/Reel

Absolute Maximum Ratings (TA=25°C unless otherwise noted)

Parameter	Symbol	Limit	Unit
Drain-Source Voltage	V_{DS}	100	V
Gate-Source Voltage	V_{GS}	± 20	V
Drain Current-Continuous	I_D	7	A
Drain Current-Pulsed (Note 1)	I_{DM}	21	A
Maximum Power Dissipation	P_D	17	W
Single pulsed avalanche energy (Note 5)	E_{AS}	1.2	mJ
Operating Junction and Storage Temperature Range	T_J, T_{STG}	-55 To 150	°C

Thermal Characteristic

Thermal Resistance, Junction-to-case	$R_{\theta JC}$	7.4	°C/W
Thermal Resistance, Junction-to-Ambient (Note 2)	$R_{\theta JA}$	62	°C/W

Electrical Characteristics (TA=25°C unless otherwise noted)

Parameter	Symbol	Condition	Min	Typ	Max	Unit
Off Characteristics						
Drain-Source Breakdown Voltage	BV_{DSS}	$V_{GS}=0V, I_D=250\mu A$	100	110	-	V
Zero Gate Voltage Drain Current	I_{DSS}	$V_{DS}=100V, V_{GS}=0V$	-	-	1	μA

Gate-Body Leakage Current	I_{GSS}	$V_{GS}=\pm 20V, V_{DS}=0V$	-	-	± 100	nA
On Characteristics (Note 3)						
Gate Threshold Voltage	$V_{GS(th)}$	$V_{DS}=V_{GS}, I_D=250\mu A$	1	1.95	3	V
Drain-Source On-State Resistance	$R_{DS(on)}$	$V_{GS}=10V, I_D=3.5A$	-	115	140	m Ω
Dynamic Characteristics (Note 4)						
Input Capacitance	C_{iss}	$V_{DS}=50V, V_{GS}=0V,$ $F=1.0MHz$	-	206	-	PF
Output Capacitance	C_{oss}		-	28.9	-	PF
Reverse Transfer Capacitance	C_{rss}		-	1.4	-	PF
Switching Characteristics (Note 4)						
Turn-on Delay Time	$t_{d(on)}$	$V_{DD}=50V, I_D=5A$ $V_{GS}=10V, R_{GEN}=2\Omega$	-	14.7	-	ns
Turn-on Rise Time	t_r		-	3.5	-	ns
Turn-Off Delay Time	$t_{d(off)}$		-	20.9	-	ns
Turn-Off Fall Time	t_f		-	2.7	-	ns
Total Gate Charge	Q_g	$V_{DS}=50V, I_D=5A,$ $V_{GS}=10V$	-	4.3	-	nC
Gate-Source Charge	Q_{gs}		-	1.5	-	nC
Gate-Drain Charge	Q_{gd}		-	1.1	-	nC
Gate plateau voltage	$V_{plateau}$			5.0		V
Drain-Source Diode Characteristics						
Diode Forward Current (Note 2)	I_S	$V_{GS}<V_{th}$	-	-	7	A
Pulsed Source Current	I_{SP}	$V_{GS}<V_{th}$			21	
Diode Forward Voltage (Note 3)	V_{SD}	$V_{GS}=0V, I_S=7A$	-	-	1.2	V
Reverse Recovery Time	t_{rr}	$I_F=5A, di_F/dt =$ $100A/\mu s$		32.1		nS
Reverse Recovery Charge	Q_{rr}			39.4		μC
Peak Reverse Recovery Current	I_{rrm}		-	2.1	-	A

Notes:

1. Repetitive Rating: Pulse width limited by maximum junction temperature.
2. Surface Mounted on FR4 Board, $t \leq 10$ sec.
3. Pulse Test: Pulse Width $\leq 300\mu s$, Duty Cycle $\leq 2\%$.
4. Guaranteed by design, not subject to production
5. $V_{DD}=50V, R_G=50\Omega, L=0.3mH$, starting $T_j=25^\circ C$.

Typical Electrical And Thermal Characteristics

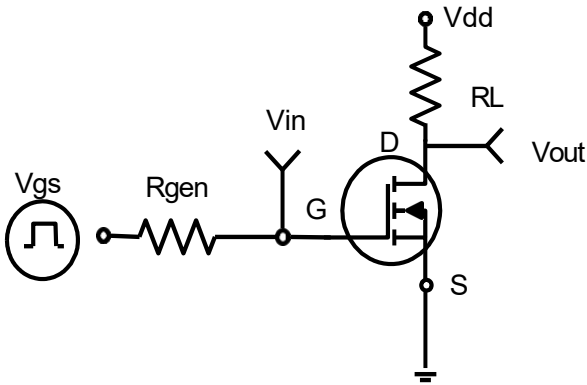

Figure 1. Switching Test Circuit

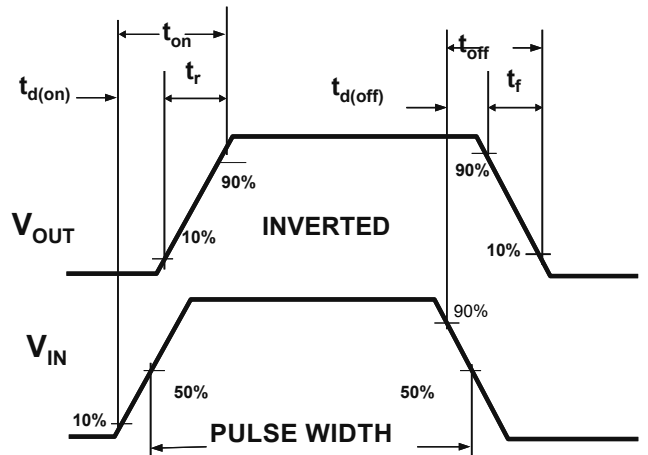

Figure 2. Switching Waveforms

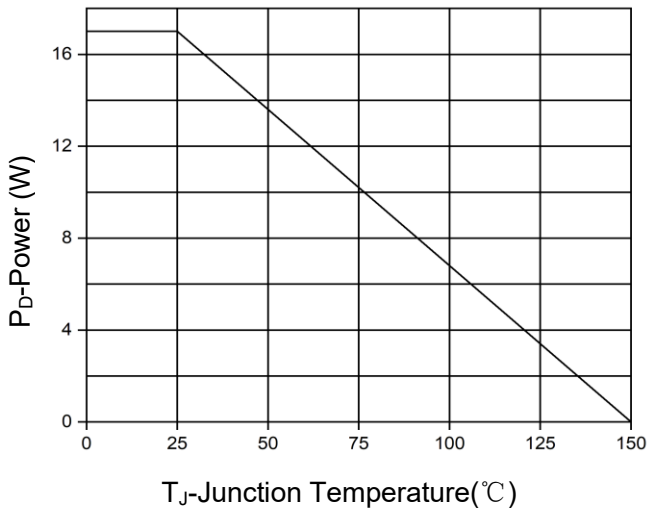

Figure 3. Power Dissipation

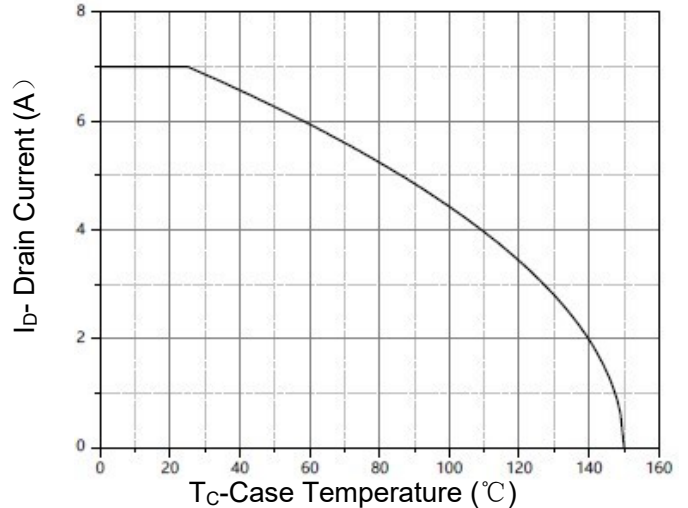

Figure 4. Drain Current

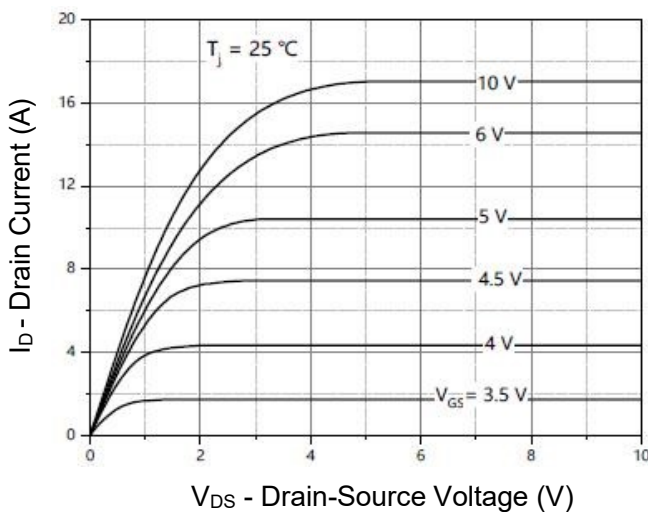

Figure 5. Output characteristics

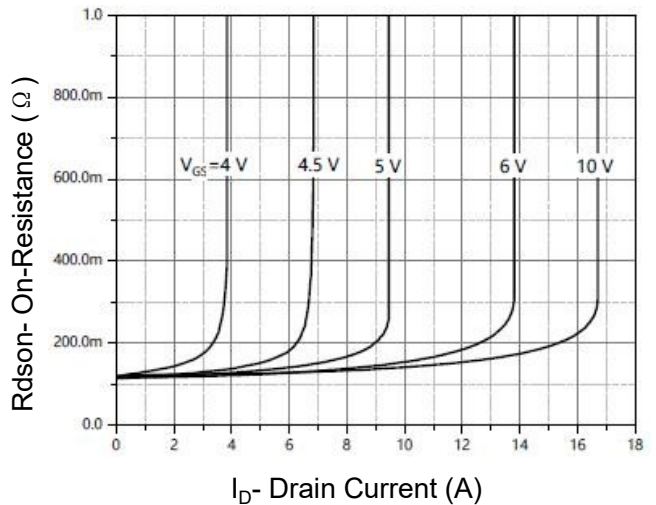

Figure 6. Drain-Source On-state resistance

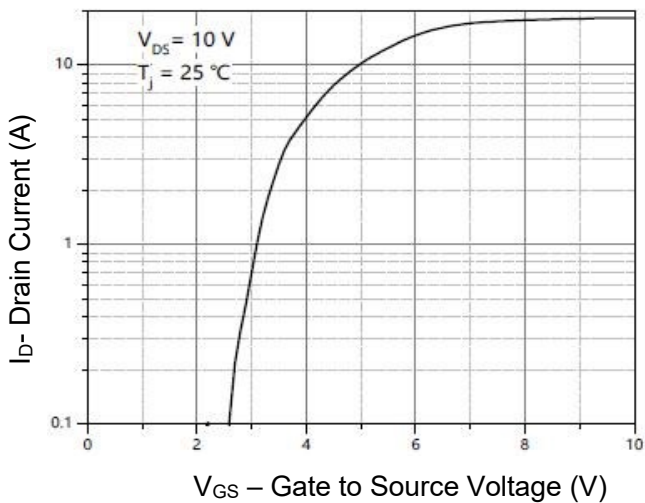

Figure 7. Transfer Characteristics

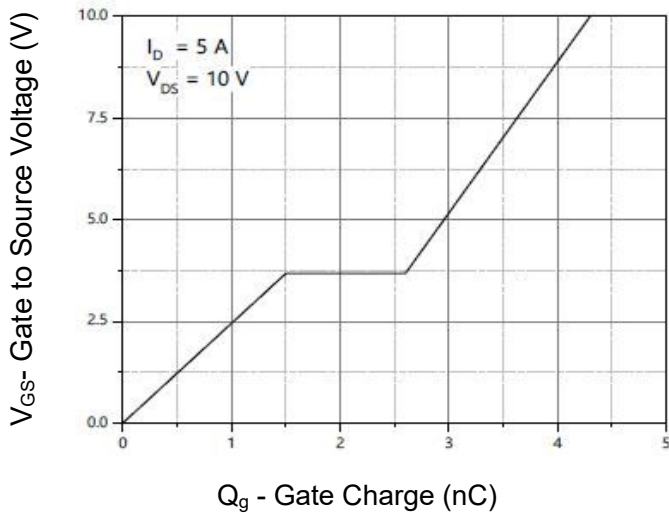

Figure 9. Gate Charge

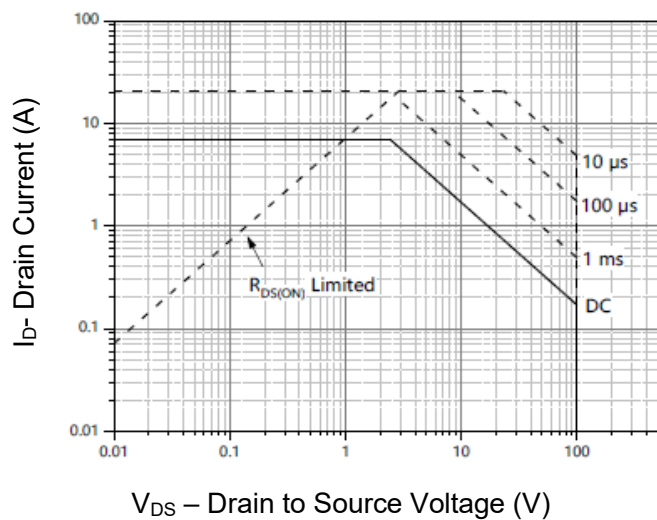

Figure 11. Safe Operation Area

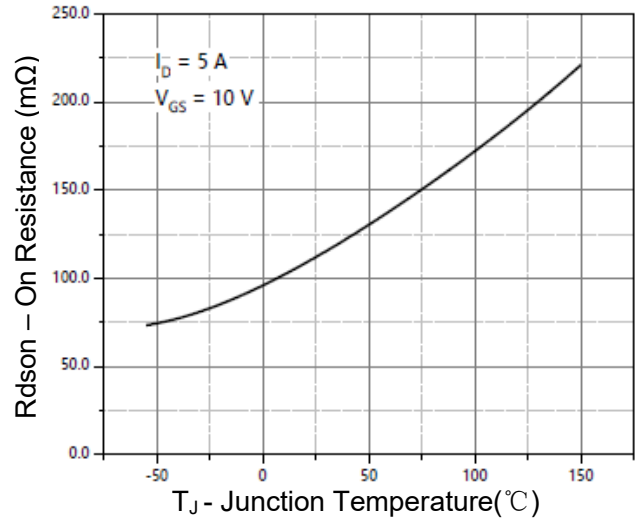

Figure 8. Drain-Source On-State Resistance

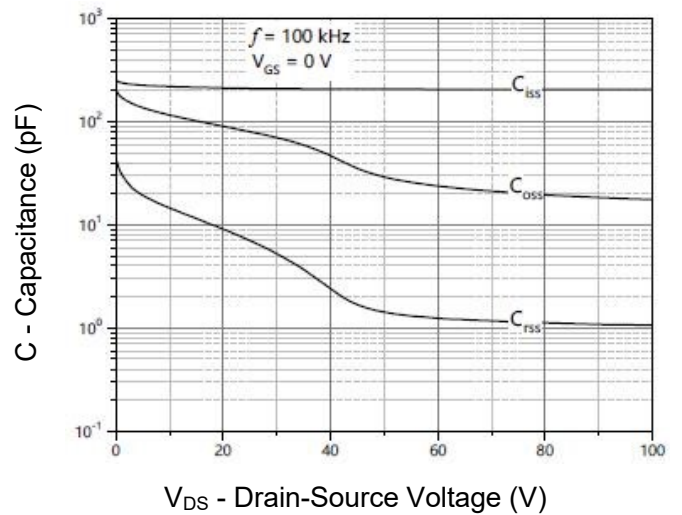

Figure 10. Capacitance vs Vds

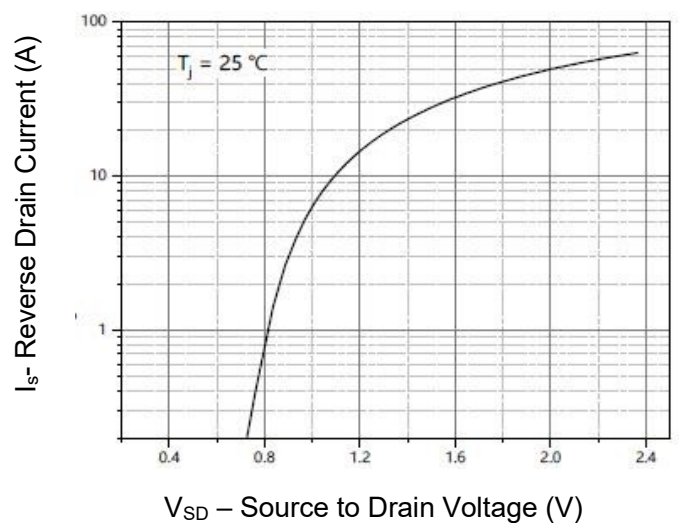

Figure 12. Source- Drain Diode Forward

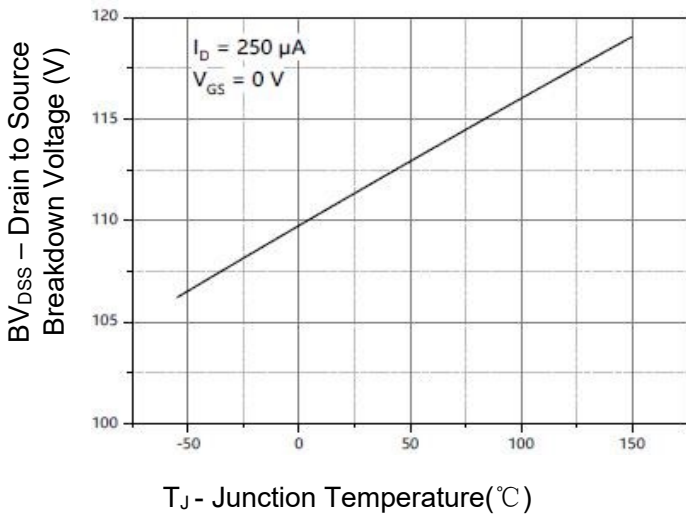
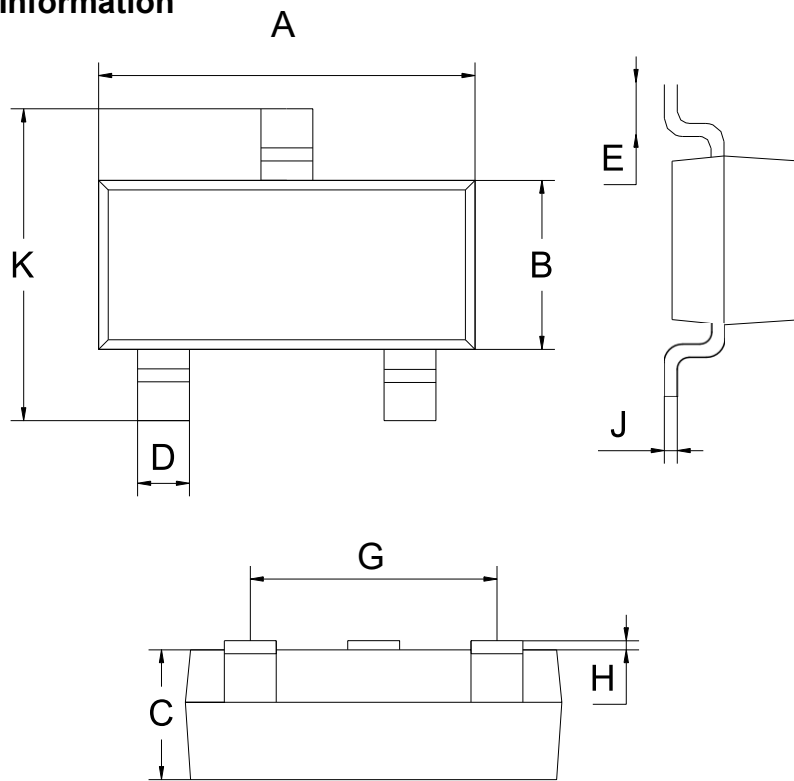

Figure 13. Drain-source breakdown voltage

SOT-23-3L Package Information



SOT-23-3L			
Dim	MIN	NOM	MAX
A	2.80	2.90	3.00
B	1.50	1.60	1.70
C	1.00	1.10	1.20
D	0.30	0.40	0.50
E	0.25	0.40	0.55
G	1.90		
H	0.00	-	0.10
J	0.047	0.127	0.207
K	2.60	2.80	3.00
All Dimensions in mm			