

# Surface Mount Transient Voltage Suppressors (TVS)

**SMDJ Series 5.0 To 440 V 3000W**

## Description

The SMDJ series is designed specifically to protect sensitive electronic equipment from voltage transients induced by lightning and other transient voltage events.

## Features

- ◆ For surface mounted applications in order to optimize board space
- ◆ Low leakage
- ◆ Uni and Bidirectional unit
- ◆ Glass passivated junction
- ◆ Low inductance
- ◆ Excellent clamping capability
- ◆ 3000W Peak power capability at 10 × 1000μs waveform Repetition rate (duty cycle):0.01%
- ◆ Fast response time: typically less than 1.0ps from 0 Volts to V<sub>BR</sub> min
- ◆ Typical I<sub>R</sub> less than 5μA above 12V.
- ◆ High Temperature soldering: 260°C/40 seconds at terminals
- ◆ Typical maximum temperature coefficient  $\Delta V_{BR} = 0.1\% \times V_{BR@25^{\circ}C} \times \Delta T$
- ◆ Plastic package has Underwriters Laboratory Flammability 94V-0
- ◆ Matte tin lead-free Plated
- ◆ Halogen free and RoHS compliant
- ◆ Typical failure mode is short from over-specified voltage or current
- ◆ Whisker test is conducted based on JEDEC JESD201A per its table 4a and 4c
- ◆ IEC-61000-4-2 ESD 15kV(Air), 8kV (Contact)
- ◆ ESD protection of data lines in accordance with IEC 61000-4-2 (IEC801-2)
- ◆ EFT protection of data lines in accordance with IEC 61000-4-4 (IEC801-4)

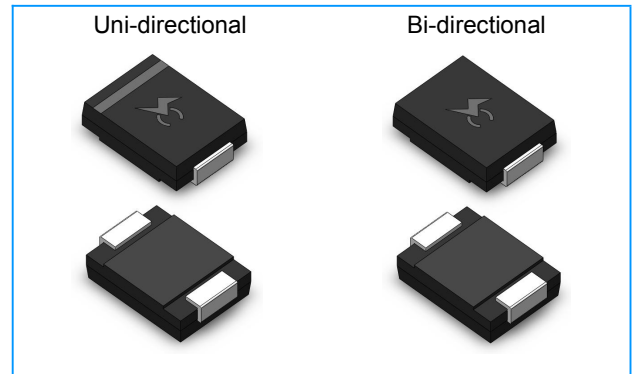

## Functional Diagram

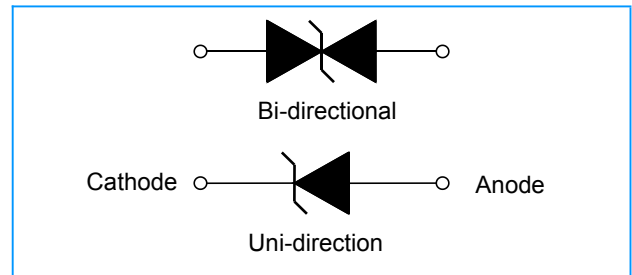

## Agency Approvals

AGENCY	AGENCY FILE NUMBER
	E341027

## Applications

TVS devices are ideal for the protection of I/O interfaces, V<sub>CC</sub> bus and other vulnerable circuits used in Telecom, Computer, Industrial and Consumer electronic applications.

## Maximum Ratings (T<sub>A</sub>=25°C unless otherwise noted)

Parameter	Symbol	Value	Unit
Peak Pulse Power Dissipation with a 10/1000μs waveform (Fig.1)(Note 1), (Note 2)	P <sub>PPM</sub>	3000	Watts
Peak Pulse Current with a 10/1000μs waveform.(Note1, Fig.3)	I <sub>PP</sub>	See Next Table	Amps
Power Dissipation on Infinite Heat Sink at T <sub>L</sub> =75°C	P <sub>M(AV)</sub>	6.0	Watt
Peak Forward Surge Current, 8.3ms Single Half Sine Wave (Note 3)	I <sub>FSM</sub>	300	Amps
Maximum Instantaneous Forward Voltage at 25A for Unidirectional Only (Note 4)	V <sub>F</sub>	3.5/5.0	Voltage
Operating junction and Storage Temperature Range.	T <sub>J</sub> , T <sub>STG</sub>	-55 to +150	°C

### Notes:

1. Non-repetitive current pulse, per Fig. 3 and derated above T<sub>A</sub> = 25°C per Fig. 2.
2. Mounted on 5.0mm x 5.0mm (0.03mm thick) Copper Pads to each terminal.
3. 8.3ms single half sine-wave, or equivalent square wave, Duty cycle = 4 pulses per minutes maximum.
4. V<sub>F</sub> < 3.5V for V<sub>BR</sub> < 200V and V<sub>F</sub> < 6.5V for V<sub>BR</sub> > 201V.

## Surface Mount Transient Voltage Suppressors (TVS)

**SMDJ Series 5.0 To 440 V 3000W**

Electrical Characteristics ( $T_A=25^\circ\text{C}$  unless otherwise noted)

Part Number		Marking		Reverse Stand-Off Voltage $V_{RWM}$ (V)	Breakdown Voltage $V_{BR}$ (V) @ $I_T$		Test Current $I_T$ (mA)	Maximum Clamping Voltage $V_C$ @ $I_{PP}$ (V)	Maximum Peak Pulse Current $I_{PP}$ (A)	Maximum Reverse Leakage $I_R$ @ $V_{RWM}$ ( $\mu\text{A}$ )
Uni	Bi	Uni	Bi		MIN	MAX				
SMDJ5.0A	SMDJ5.0CA	RDE	DDE	5.0	6.40	7.00	10	9.2	326.09	1000
SMDJ6.0A	SMDJ6.0CA	RDG	DDG	6.0	6.67	7.37	10	10.3	291.26	1000
SMDJ6.5A	SMDJ6.5CA	RDK	DDK	6.5	7.22	7.98	10	11.2	267.86	500
SMDJ7.0A	SMDJ7.0CA	PDM	DDM	7.0	7.78	8.60	10	12.0	250.00	200
SMDJ7.5A	SMDJ7.5CA	PDP	DDP	7.5	8.33	9.21	1	12.9	232.56	100
SMDJ8.0A	SMDJ8.0CA	PDR	DDR	8.0	8.89	9.83	1	13.6	220.59	50
SMDJ8.5A	SMDJ8.5CA	PDT	DDT	8.5	9.44	10.40	1	14.4	208.33	25
SMDJ9.0A	SMDJ9.0CA	PDV	DDV	9.0	10.00	11.10	1	15.4	194.81	10
SMDJ10A	SMDJ10CA	PDX	DDX	10.0	11.10	12.30	1	17.0	176.47	5
SMDJ11A	SMDJ11CA	PDZ	DDZ	11.0	12.20	13.50	1	18.2	164.84	5
SMDJ12A	SMDJ12CA	PEE	DEE	12.0	13.30	14.70	1	19.9	150.75	5
SMDJ13A	SMDJ13CA	PEG	DEG	13.0	14.40	15.90	1	21.5	139.53	5
SMDJ14A	SMDJ14CA	PEK	DEK	14.0	15.60	17.20	1	23.2	129.31	5
SMDJ15A	SMDJ15CA	PEM	DEM	15.0	16.70	18.50	1	24.4	122.95	5
SMDJ16A	SMDJ16CA	PEP	DEP	16.0	17.80	19.70	1	26.0	115.38	5
SMDJ17A	SMDJ17CA	PER	DER	17.0	18.90	20.90	1	27.6	108.70	5
SMDJ18A	SMDJ18CA	PET	DET	18.0	20.00	22.10	1	29.2	102.74	5
SMDJ19A	SMDJ19CA	PEB	DEB	19.0	21.10	23.30	1	30.8	97.47	5
SMDJ20A	SMDJ20CA	PEV	DEV	20.0	22.20	24.50	1	32.4	92.59	5
SMDJ22A	SMDJ22CA	PEX	DEX	22.0	24.40	26.90	1	35.5	84.51	5
SMDJ24A	SMDJ24CA	PEZ	DEZ	24.0	26.70	29.50	1	38.9	77.12	5
SMDJ26A	SMDJ26CA	PFE	DFE	26.0	28.90	31.90	1	42.1	71.26	5
SMDJ28A	SMDJ28CA	PFG	DFG	28.0	31.10	34.40	1	45.4	66.08	5
SMDJ30A	SMDJ30CA	PFK	DFK	30.0	33.30	36.80	1	48.4	61.98	5
SMDJ33A	SMDJ33CA	PFM	DFM	33.0	36.70	40.60	1	53.3	56.29	5
SMDJ36A	SMDJ36CA	PFP	DFP	36.0	40.00	44.20	1	58.1	51.64	5
SMDJ40A	SMDJ40CA	PFR	DFR	40.0	44.40	49.10	1	64.5	46.51	5
SMDJ43A	SMDJ43CA	PFT	DFT	43.0	47.80	52.80	1	69.4	43.23	5

## Surface Mount Transient Voltage Suppressors (TVS)

SMDJ Series 5.0 To 440 V 3000W

Electrical Characteristics ( $T_A=25^\circ\text{C}$  unless otherwise noted) (Continue)

Part Number		Marking		Reverse Stand-Off Voltage $V_{RWM}$ (V)	Breakdown Voltage $V_{BR}$ (V) @ $I_T$		Test Current $I_T$ (mA)	Maximum Clamping Voltage $V_C$ @ $I_{PP}$ (V)	Maximum Peak Pulse Current $I_{PP}$ (A)	Maximum Reverse Leakage $I_R$ @ $V_{RWM}$ ( $\mu\text{A}$ )
Uni	Bi	Uni	Bi		MIN	MAX				
SMDJ45A	SMDJ45CA	PFV	DFV	45.0	50.00	55.30	1	72.7	41.27	5
SMDJ48A	SMDJ48CA	PFX	DFX	48.0	53.30	58.90	1	77.4	38.76	5
SMDJ51A	SMDJ51CA	PFZ	DFZ	51.0	56.70	62.70	1	82.4	36.41	5
SMDJ54A	SMDJ54CA	RGE	DGE	54.0	60.00	66.30	1	87.1	34.44	5
SMDJ58A	SMDJ58CA	PGG	DGG	58.0	64.40	71.20	1	93.6	32.05	5
SMDJ60A	SMDJ60CA	PGK	DGK	60.0	66.70	73.70	1	96.8	30.99	5
SMDJ64A	SMDJ64CA	PGM	DGM	64.0	71.10	78.60	1	103.0	29.13	5
SMDJ70A	SMDJ70CA	PGP	DGP	70.0	77.80	86.00	1	113.0	26.55	5
SMDJ75A	SMDJ75CA	PGR	DGR	75.0	83.30	92.10	1	121.0	24.79	5
SMDJ78A	SMDJ78CA	PGT	DGT	78.0	86.70	95.80	1	126.0	23.81	5
SMDJ80A	SMDJ80CA	PGB	DGB	80.0	88.80	97.60	1	129.6	23.15	5
SMDJ85A	SMDJ85CA	PGV	DGV	85.0	94.40	104.00	1	137.0	21.90	5
SMDJ90A	SMDJ90CA	PGX	DGX	90.0	100.00	111.00	1	146.0	20.55	5
SMDJ100A	SMDJ100CA	PGZ	DGZ	100.0	111.00	123.00	1	162.0	18.52	5
SMDJ110A	SMDJ110CA	PHE	DHE	110.0	122.00	135.00	1	177.0	16.95	5
SMDJ120A	SMDJ120CA	PHG	DHG	120.0	133.00	147.00	1	193.0	15.54	5
SMDJ130A	SMDJ130CA	PHK	DHK	130.0	144.00	159.00	1	209.0	14.35	5
SMDJ140A	SMDJ140CA	PHB	DHB	140.0	155.00	171.00	1	226.8	13.23	5
SMDJ150A	SMDJ150CA	PHM	DHM	150.0	167.00	185.00	1	243.0	12.35	5
SMDJ160A	SMDJ160CA	PHP	DHP	160.0	178.00	197.00	1	259.0	11.58	5
SMDJ170A	SMDJ170CA	PHR	DHR	170.0	189.00	209.00	1	275.0	10.91	5
SMDJ180A	SMDJ180CA	PHT	DHT	180.0	201.00	220.00	1	291.6	10.29	5
SMDJ190A	SMDJ190CA	PHV	DHV	190.0	211.00	232.00	1	307.8	9.75	5
SMDJ200A	SMDJ200CA	PHW	DHW	200.0	224.00	247.00	1	324.0	9.26	5
SMDJ220A	SMDJ220CA	PHX	DHX	220.0	246.00	272.00	1	356.0	8.43	5
SMDJ250A	SMDJ250CA	PHZ	DHZ	250.0	279.00	309.00	1	405.0	7.41	5
SMDJ300A	SMDJ300CA	PJE	DJE	300.0	335.00	371.00	1	486.0	6.17	5
SMDJ350A	SMDJ350CA	PJG	DJG	350.0	391.00	432.00	1	567.0	5.29	5
SMDJ400A	SMDJ400CA	PJK	DJK	400.0	447.00	494.00	1	648.0	4.63	5
SMDJ440A	SMDJ440CA	PJM	DJM	440.0	492.00	543.00	1	713.0	4.21	5

**Note:**

1. Suffix 'A' denotes 5% tolerance device.
2. Add suffix 'CA' after part number to specify Bi-directional devices.
3. For Bi-Directional devices having  $V_R$  of 10 volts and under, the  $I_R$  limit is double.

# Surface Mount Transient Voltage Suppressors (TVS)

**SMDJ Series 5.0 To 440 V 3000W**

Ratings and Characteristic Curves ( $T_A=25^\circ\text{C}$  unless otherwise noted)

**Figure 1 - Peak Pulse Power Rating Curve**

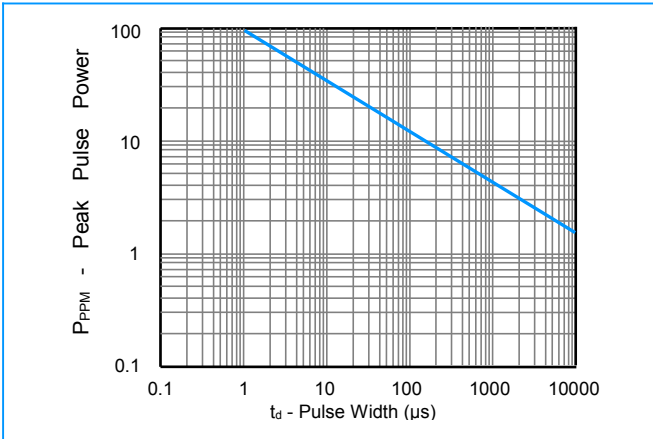

**Figure 2 - Pulse Derating Curve**

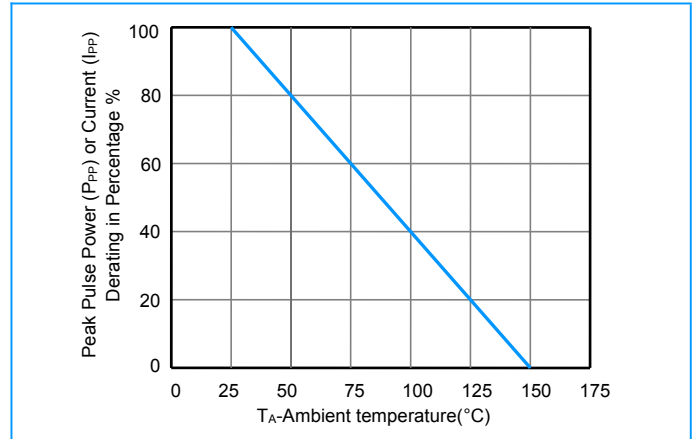

**Figure 3 - Pulse Waveform**

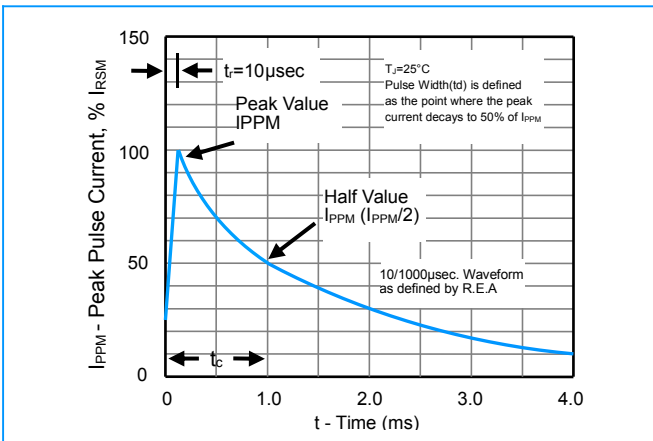

**Figure 4 - Typical Junction Capacitance**

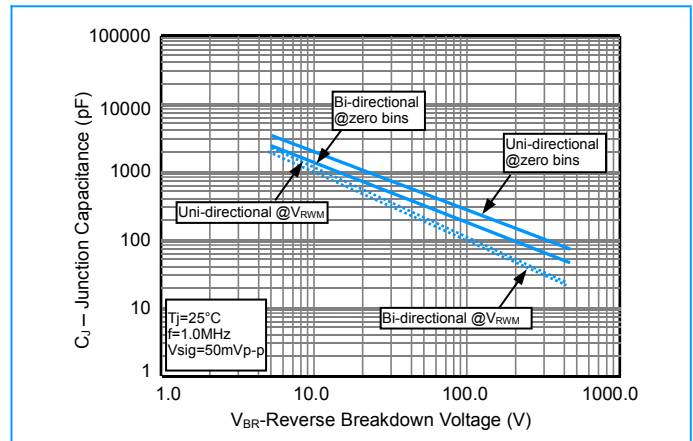

**Figure 5 - Steady State Power Derating Curve**

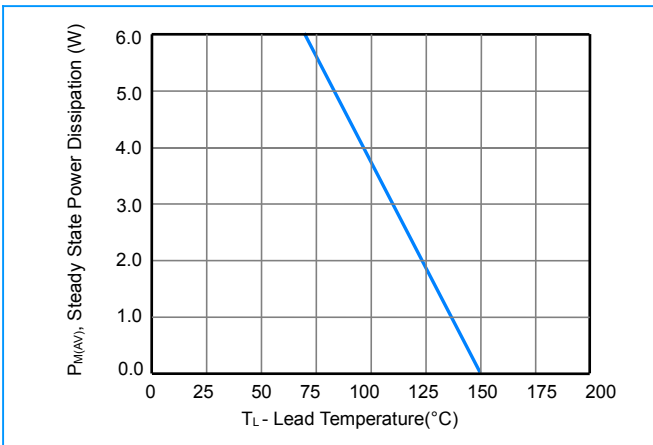

**Figure 6 - Maximum Non-Repetitive Surge Current**

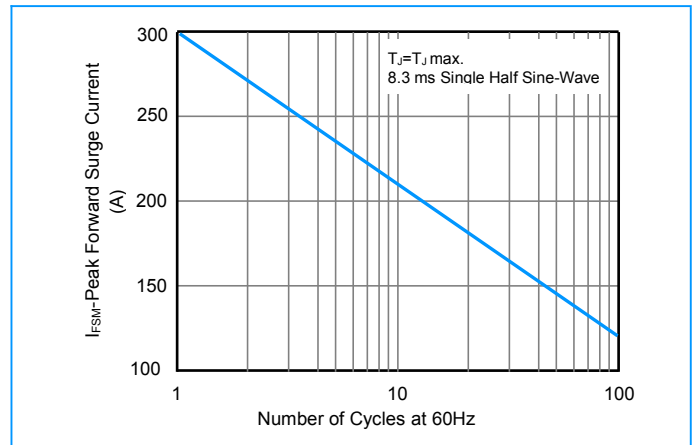

# Surface Mount Transient Voltage Suppressors (TVS)

**SMDJ Series 5.0 To 440 V 3000W**

## I-V Curve Characteristics

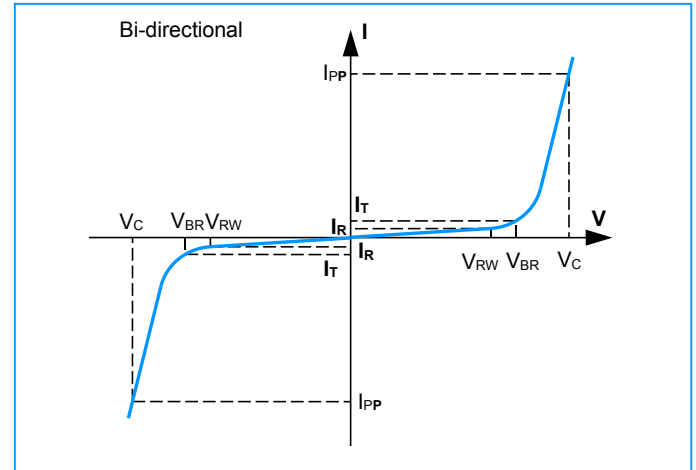
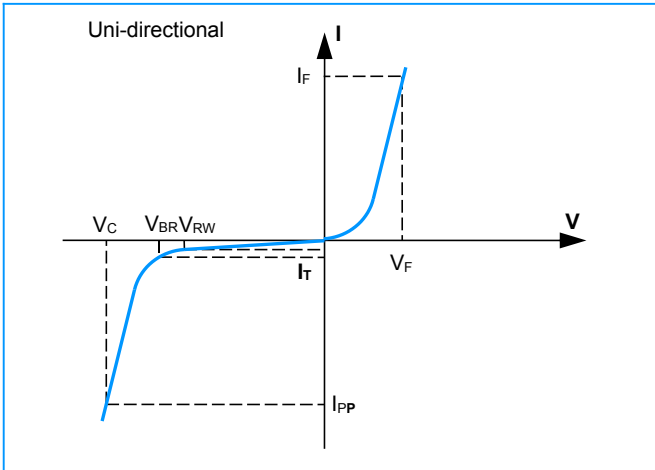

## Physical Specifications

<b>Weight</b>	0.007 ounce, 0.21 gram
<b>Case</b>	JEDEC DO-214AB Molded Plastic over glass passivated junction
<b>Polarity</b>	Color band denotes cathode except Bipolar
<b>Terminal</b>	Matte Tin-plated leads, Solderable per JESD22-B102D

## Environmental Specifications

<b>Temperature Cycle</b>	JESD22-A104
<b>Pressure Cooker</b>	JESD22-A102
<b>High Temp. Storage</b>	JESD22-A103
<b>HTRB</b>	JESD22-A108
<b>Thermal Shock</b>	JESD22-A106

## Soldering Parameters

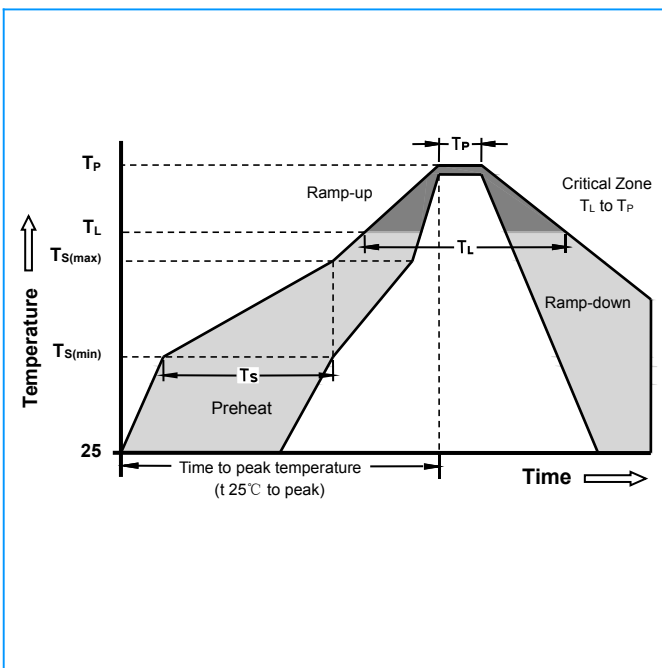

Reflow Condition		Lead-free assembly
Pre Heat	-Temperature Min ( $T_{S(min)}$ )	150°C
	-Temperature Max ( $T_{S(max)}$ )	200°C
	- Time (min to max) ( $T_S$ )	60 - 180 Seconds
Average ramp up rate ( Liquidus Temp $T_L$ ) to peak		3°C/second max
$T_{S(max)}$ to $T_L$ - Ramp-up Rate		3°C/second max
Reflow	- Temperature ( $T_L$ ) (Liquidus)	217°C
	- Time (min to max) ( $T_L$ )	60 - 150 Seconds
Peak Temperature ( $T_P$ )		260 +0/-5°C
Time within 5°C of actual peak Temperature ( $t_p$ )		20 - 40 Seconds
Ramp-down Rate		6°C/second max
Time 25°C to peak Temperature ( $T_P$ )		8 minutes Max
Do not exceed		280°C

# Surface Mount Transient Voltage Suppressors (TVS)

**SMDJ Series 5.0 To 440 V 3000W**

## Dimensions

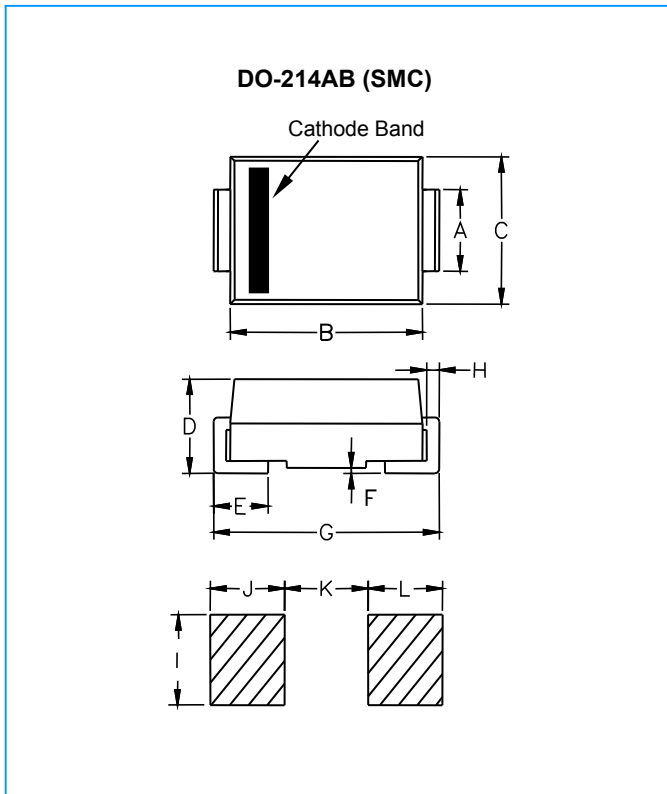

Dimensions	Inches		Millimeters	
	Min	Max	Min	Max
A	0.108	0.126	2.75	3.20
B	0.260	0.280	6.52	7.11
C	0.220	0.244	5.52	6.20
D	0.079	0.103	1.98	2.62
E	0.030	0.060	0.75	1.52
F	-	0.008	-	0.203
G	0.305	0.320	7.64	8.13
H	0.006	0.012	0.15	0.31
I	0.121	-	3.07	-
J	0.0675	-	1.715	-
K	-	0.185	-	4.69
L	0.0675	-	1.715	-

## Part Numbering

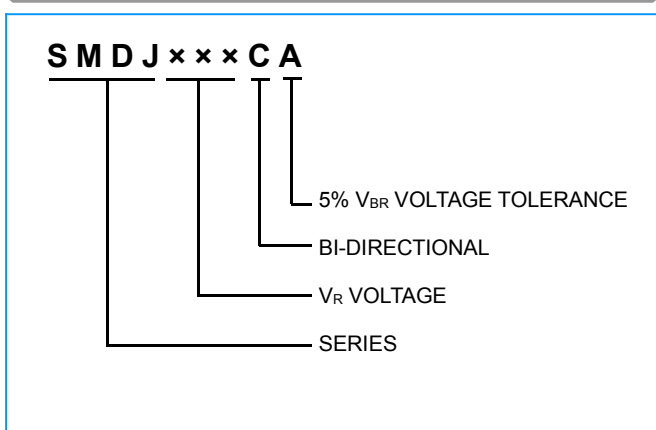

## Part Marking

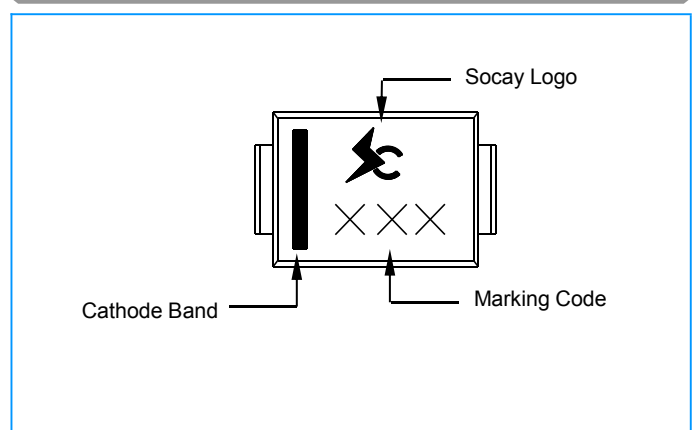

## Surface Mount Transient Voltage Suppressors (TVS)

**SMDJ Series 5.0 To 440 V 3000W**

### Packaging

Part Number	Component Package	Reel (pcs)	Per Carton (pcs)	Packaging Option	Reel Diameters (mm)
SMDJXXXXX	DO-214AB (SMC)	3000	48000	Tape & Reel -20mm/13"tape	330.0

### Tape and Reel Specifications

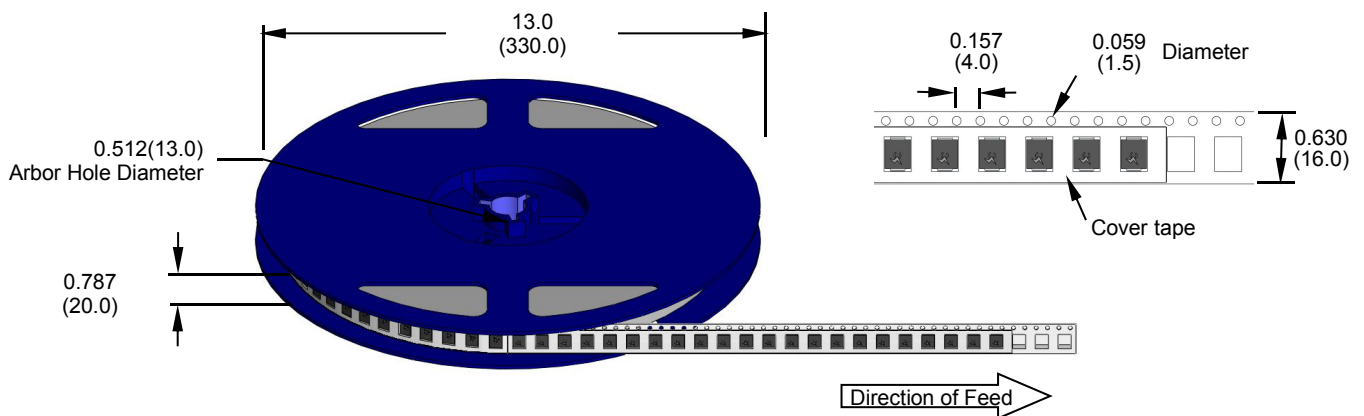

Dimensions are in inches  
(and millimeters)