



管理号: U2-E08

STANDARD SPECIFICATION

产品规格书

客户 Customer: _____

客户料号 Customer P/N NO.: _____

产品描述 Product Description: SX-3225 26.000MHZ 10.5PF ±7PPM

TKD 料号 TKD P/N. NO.: SX32Y026000M31T-10.5U

客户批准 Customer Approval :

(请批准后回签一份 PLEASE RETURN A COPY WITH APPROVAL)

湖北泰晶电子科技股份有限公司

HUBEI TKD ELECTRONICS TECHNOLOGY CO., LTD.

随州泰华电子科技有限公司

SUIZHOU TAIWARD ELECTRONIC TECHNOLOGY CO., LTD

| 批准 APPROVED | 审核 CHECK | 制作 DESIGNER |
|----------------|-------------|----------------|
| 杨勇 | 金婷 | 周芮 |

地址: 湖北省随州市经济开发区深圳工业园

ADD: SHENZHEN INDUSTRIAL PARK, SUIZHOU ECONOMIC DEVELOPMENT ZONE, HUBEI

SALES TEL: 0722-7509016, FAX: 0722-7509036 URL: www.sztkd.com

FMT: TH-QW-RD2-23 Ver: C0



REVISION RECORD

| Rev | Date | NO. | Description of Revision History |
|-----|------------|-----|---------------------------------|
| 00 | 2018-01-28 | | New Publication |
| 01 | 2018-07-17 | | Change format version : C |

地址：湖北省随州市经济开发区深圳工业园

ADD: SHENZHEN INDUSTRIAL PARK, SUIZHOU ECONOMIC DEVELOPMENT ZONE, HUBEI

SALES TEL: 0722-7509016, FAX: 0722-7509036 URL:www.sztkd.com

FMT: TH-QW-RD2-23 Ver:C0



Spec Sheet Contents

| NO. | Content | Page |
|-----|--|-------|
| 1 | 石英晶体参数规格 QUARTZ CRYSTAL UNIT SPECIFICATION | 4-5 |
| 2 | 产品图纸 DIMENSIONS | 6 |
| 3 | 印字内容 MARKING | 6 |
| 4 | 内部结构 INSIDE STRUCTURE | 7 |
| 5 | 等效电路图 EQUIVALENT CIRCUIT | 7 |
| 6 | 包装 PACKING | 8 |
| 7 | 回流焊温度曲线 REFLOW PROFILES | 9 |
| 8 | 可靠性试验 RELIABILITY SPECIFICATIOND | 10-11 |
| 9 | 工艺流程图 FLOW CHART | 12 |
| 10 | 有害物质含量声明 HARMFUL SUBSTANCE CONTENT STATEMENT | 13 |
| | | |
| | | |
| | | |
| | | |
| | | |
| | | |
| | | |
| | | |
| | | |
| | | |

地址：湖北省随州市经济开发区深圳工业园

ADD: SHENZHEN INDUSTRIAL PARK, SUIZHOU ECONOMIC DEVELOPMENT ZONE, HUBEI

SALES TEL: 0722-7509016, FAX: 0722-7509036 URL: www.sztkd.com

FMT: TH-QW-RD2-23 Ver:C0



1. 石英晶体参数规格 QUARTZ CRYSTAL UNIT SPECIFICATION

※描述 Description : Quartz Crystal
 ※产品型别 Product Type : SX-3225
 ※水晶切割模式 Crystal cutting type : AT-CUT
 ※测量设备 Measure equipment : S&A 250B
 ※电气特性 Electrical Characteristics

| | 项目 Item | 代码 Symbol | 电气特性规格 Electrical Specification | | | | 备注 Notes |
|----|--|--------------|------------------------------------|------------|------------|-------------|---|
| | | | 下限 Min. | 中心 Typ. | 上限 Max. | 单位 Units | |
| 1 | 一般频率 Nominal Frequency | F0 | 26.000000 | | | MHz | |
| 2 | 振荡模式 Oscillation Mode | - | Fundamental | | | - | |
| 3 | 负载电容 Load Capacitance | CL | 10.5 | | | pF | |
| 4 | 频率公差 Frequency Tolerance | - | -7 | - | 7 | ppm | At 25°C ±3°C |
| 5 | 等效串联电阻 Equivalent Series Resistance | ESR | - | - | 30 | Ω | |
| 6 | 驱动功率 Drive Level | DL | - | - | 100 | μW | |
| 7 | 频率稳定度 Frequency Stability | TC | -15 | - | 15 | ppm | Over Operating Temp. Range (Ref. to 25°C) |
| 8 | 动作温度 Operating Temperature | - | -40 | - | 85 | °C | |
| 9 | 储存温度 Storage Temperature | - | -40 | - | 85 | °C | |
| 10 | 老化率 Aging | - | -3 | - | 3 | ppm | Per Year |
| 11 | 绝缘阻抗 Insulation Resistance | - | 500 | - | - | MΩ | At DC 100V |
| 12 | 并联电容 Shunt Capacitance | C0 | - | - | 3 | pF | |

地址：湖北省随州市经济开发区深圳工业园

ADD: SHENZHEN INDUSTRIAL PARK, SUIZHOU ECONOMIC DEVELOPMENT ZONE, HUBEI

SALES TEL: 0722-7509016, FAX: 0722-7509036 URL: www.sztkd.com

FMT: TH-QW-RD2-23 Ver: C0



备注 Notes:

1. 超声波清洗 Ultrasonic cleaning

一般的清洁液或超声波清洗方法可以用来清洗我们的产品。但是，在某些情况下，超声波清洗机在我们产品的振荡频率上会产生共振，从而使器件的电气特性恶化，甚至损坏器件的整体结构。因此，建议超声波清洗前进行验证测试。General cleaning solutions or ultrasonic cleaning method may be used to clean our products. However, under certain circumstances, ultrasonic cleaning machine could generate resonance at the oscillaton frequency of our products and thus deteriorate the electrical characteristics in devices, and even damage the overall structure of devices. Therefore, verification test is recommended before cleaning.

2. 超声波焊接 Ultrasonic welding

避免使用超声波焊接进行安装和加工，这种方法有可能使晶体产品内部产生过大的振动扩散，成为特性退化而不振动的的原因。Avoid mounting and processing by Ultrasonic welding this method has a possibility of an excessive vibration spreading inside the crystal products and becoming the cause of characteristic deterioration and not oscillating.

3. 储存温度说明 Storage temperature description

储存温度仅适用于产品，而包装材料储存温度 5°C~40°C。Storage Temperature is only for the product itself, the temperature for the packing material is 5°C~40°C.

4. 手工焊建议条件 Recommended conditions for manual welding

温度：350±10°C, 时间：3 秒 Max , 次数：2 次 Max . Temperature: 350 ± 10 °C, Time: 3 sec max, Re-solder times: twice max.



2. 产品图纸 DIMENSIONS (Units:mm)

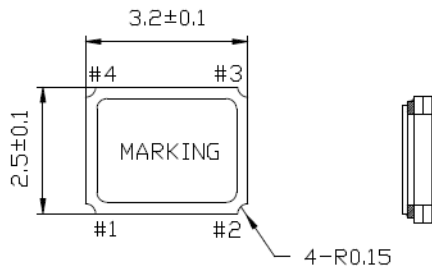

| PIN CONNECT | |
|-------------|---------|
| 1,3 | Crystal |
| 2,4 | GND |

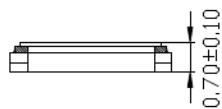

<TOP VIEW>

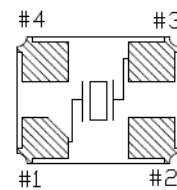

LAND PATTERN<REFERENCE>

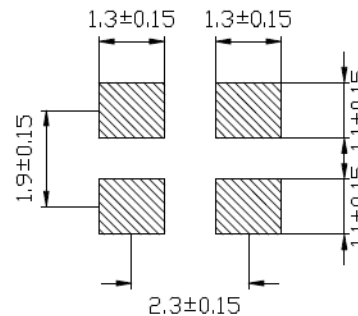
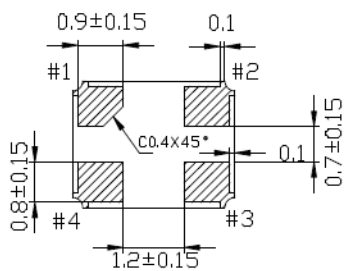

3. 印字 MARKING

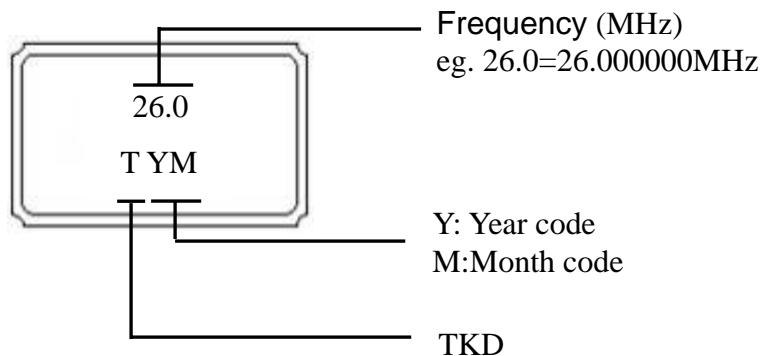

Year : 1 2 3 4 5 6 7 8 9 0

Month : 1 2 3 4 5 6 7 8 9 10 11 12

Code: A B C D E F G H J K L M

4. 内部结构产品图纸 INSIDE STRUCTURE

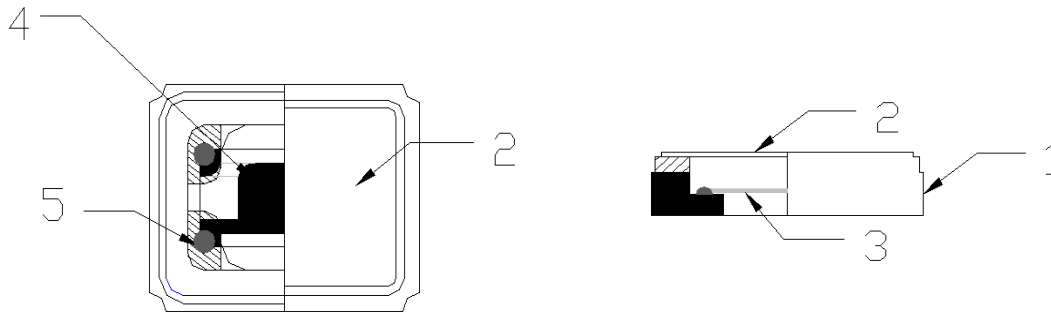

| No. | 组件 COMPONENTS | 材料成份 MATERIALS |
|-----|----------------------|--------------------------|
| 1 | 基座 Package | 陶瓷 Ceramic (Al2O3) |
| 2 | 外壳 LID | KV 合金 KV (Fe/Co/Ni) |
| 3 | 水晶片 Crystal blank | 二氧化硅 SiO2 |
| 4 | 电极 Electrode | 贵金属银 Noble Metal (Ag) |
| 5 | 接着剂 Adhesive | 树脂、银粉 Resin, Ag |

5. 等效电路图 EQUIVALENT CIRCUIT

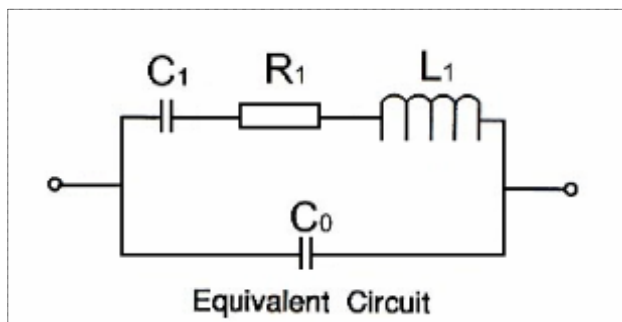

6. 包装 PACKING (Units:mm)

※载带类型 CARRIER TYPE

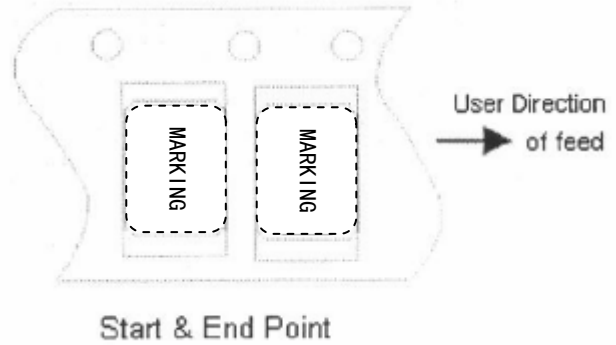
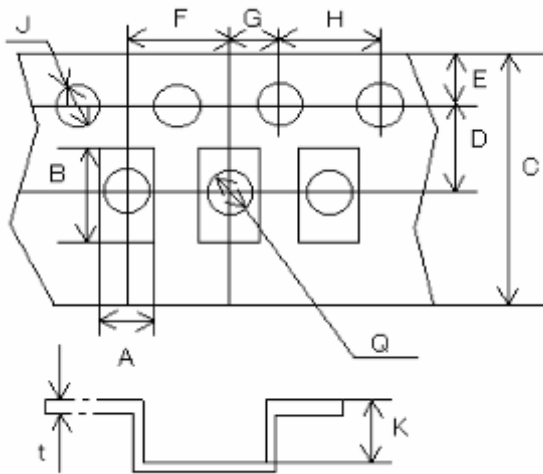

| A | B | C | D | E | F | G | H | J | K | t |
|-----|-----|-----|-----|------|-----|-----|-----|------|-----|------|
| 2.7 | 3.4 | 8.0 | 3.5 | 1.75 | 4.0 | 2.0 | 4.0 | 1.55 | 1.4 | 0.25 |

备注 REMARK:

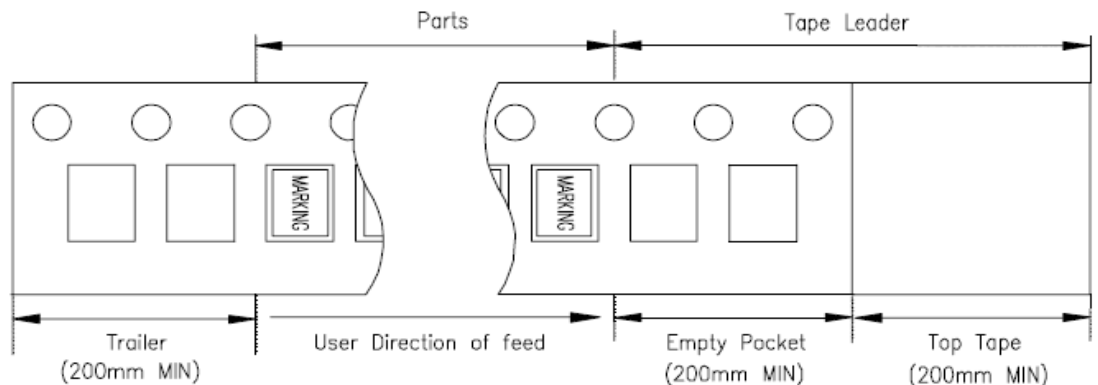

※圆卷 REEL: 3000 PCS/Reel

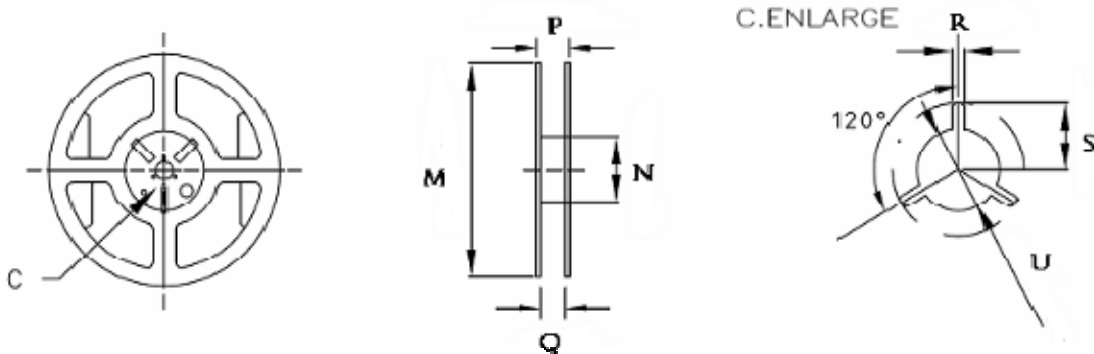

| M | N | P | Q | R | S | U |
|-------|------|------|-----|-----|------|------|
| 178.0 | 60.2 | 11.5 | 8.0 | 2.5 | 11.0 | 13.0 |

地址: 湖北省随州市经济开发区深圳工业园

ADD: SHENZHEN INDUSTRIAL PARK, SUIZHOU ECONOMIC DEVELOPMENT ZONE, HUBEI

SALES TEL: 0722-7509016, FAX: 0722-7509036 URL: www.sztkd.com

FMT: TH-QW-RD2-23 Ver:C0



7. 回流焊温度曲线 REFLOW PROFILES

参考标准 REFER: JEDEC J-STD-020D

| Profiles Feature | Pb-Free Assembly |
|---|------------------|
| Preheat/Soak | |
| Temperature Min (Ts min) | 150°C |
| Temperature Max (Ts max) | 200°C |
| Time (Ts) from (Ts min to Ts max) | 60-120 seconds |
| Ramp-up rate (TL to TP) | 3°C/second max. |
| Liquidous temperature (TL) | 217°C |
| Time (TL) maintained above TL | 60-150 seconds |
| Peak/Classification Temperature (TP) | 260±5°C |
| Time within 5°C of actual Peak Temperature (TP) | 20~40 seconds |
| Ramp-down rate (TP to TL) | 6°C/second max. |
| Time 25 ° C to peak temperature | 8 minutes max. |
| Suggest reflow times | 3 Times max |

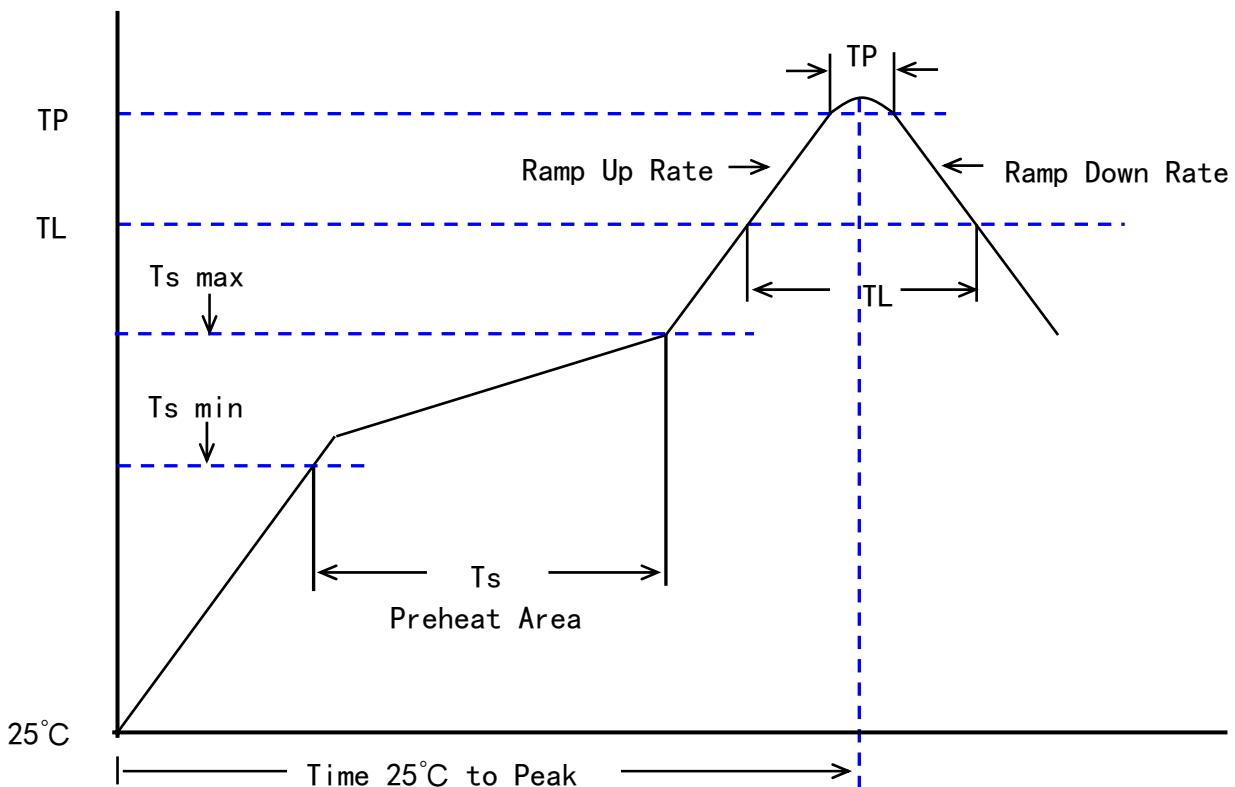

地址: 湖北省随州市经济开发区深圳工业园

ADD: SHENZHEN INDUSTRIAL PARK, SUZHOU ECONOMIC DEVELOPMENT ZONE, HUBEI

SALES TEL: 0722-7509016, FAX: 0722-7509036 URL: www.sztkd.com

FMT: TH-QW-RD2-23 Ver: C0



8. 可靠性试验 RELIABILITY SPECIFICATION

| 参考标准 REFER | | JIS C 6701 | |
|------------|--|--|------------------|
| NO. | 项目 ITEM | 测试条件 CONDITIONS | 测试标准 Criteria |
| 1 | 跌落 FREE FALL | 从75cm位置高度, 自由跌落在木板上, 连续3次 FREE DROPPING FROM 75 cm HEIGHT 3 TIMES ON A HARD | A. C |
| 2 | 振动 VIBRATION | 振动频率: 10~55 Hz, 振幅: 1.5mm±15%, 时间: 每个方位三面(X、Y、Z)各振动2小时 FREQUENCY: 10~55Hz AMPLITUDE (TOTAL EXCURSION): 1.5mm±15%, SWEEP TIME: 1MIN, 3 DIRECTION(X, Y, Z) EACH FOR 2 Hrs. | A. C |
| 3 | 冷热冲击 TEMPERATURE CYCLE | 晶体放入试验箱中, 高、低温循环100次 THE CRYSTAL UNIT SHALL BE SUBJECTED TO 100 SUCCESSIVE CHANGE OF TEMPERATURE CYCLES  | A. C. H |
| 4 | 气密性(大漏) GROSS LEAK | 标准件自动压差比对测试 STANDARD SAMPLE FOR AUTOMATIC GROSS LEAK DETECTOR | E |
| 4 | 气密性(小漏) FINE LEAK | 氦气压力标准: 5.0~5.5Kg/cm ² , 加压时间: 2小时 HELIUM BOMBING 5.0~5.5 Kgf / cm ² , FOR 2 HOURS. | F |
| 5 | 可焊性 SOLDERABILITY | 温度: 260±5°C, 浸锡时间: 2±0.6秒 THE LEAD IS IMMERSERD IN A 260±5°C SOLDER BATH WITHIN 2±0.6 SECONDS. | G |
| 6 | 高温高湿 HIGH TEMP. & HUMIDITY | 温度: 60°C ± 2°C, 湿度: 90%~95%, 保持时间: 500个小时 STORED AT 60±2°C AND HUMIDITY 90~95% FOR 500±12 H. | A. C. D. H |
| 7 | 高温存储 HIGH TEMPERATURE STORAGE | 高温温度: 85°C ± 2°C, 时间: 720±12个小时 如果客户的温度要求是高于标准, 则必须根据客户的要求测试 STORED AT 85±2°C FOR 720±12H. If Customer's temperature request is higher than the standard, Temperature test must be done for customer requirements | A. C. H |
| 8 | 低温存储 LOW TEMPERATURE | 低温温度: -40°C ± 2°C, 时间: 500±12个小时 STORED AT -40±2°C FOR 500±12H. 如果客户的温度要求是低于标准, 则必须根据客户的要求测试 | A. C. H |

地址: 湖北省随州市经济开发区深圳工业园

ADD: SHENZHEN INDUSTRIAL PARK, SUIZHOU ECONOMIC DEVELOPMENT ZONE, HUBEI

SALES TEL: 0722-7509016, FAX: 0722-7509036 URL: www.sztkd.com

FMT: TH-QW-RD2-23 Ver: C0



| | | | |
|----|-------------------------------------|--|------|
| | STORAGE | If Customer's temperature request is lower than the standard, Temperature test must be done for customer requirements | |
| 9 | 折板弯曲试验 TERMINAL STRENGTH | <p>弯曲度：3mm, 保持时间：5sec, 速度：0.5mm/sec SHALL BE PRESSURIZED AT A SPEED OF APPROX. 0.5mm/sec IN THE DIRECTION INDICATED BY THE ARROW UNTIL THE BENDING WIDTH REACHES 3mm AND HELD FOR 5 SECONDS.</p> | A. C |
| 10 | 折板推力试验 STICKING TENDENCY | <p>荷重：10N, 保持时间：10秒, 治具：R0.5 (制品侧边位置) A R0.5 JIG SHALL BE USED TO APPLY A 10N DEAD LOAD IN THE DIRECTION INDICATED BY THE ARROW TO THE ELEMENT AND RETAIN IT FOR 10 SECONDS.</p> | A. C |
| 11 | 本体荷重试验 ELEMENT ASSEMBLY STRENGTH | <p>荷重：10N, 保持时间：10秒, 治具：R0.5 (制品中心位置) A R0.5 PRESSURIZED BAR SHALL BE USED TO APPLY A 10N LOAD IN THE CENTER OF ELEMENT AND RETAIN IT FOR 10 SECONDS.</p> | A. C |

SPECIFICATIONS

| | | |
|---|--|--|
| A | FREQUENCY CHANGE PERMITTED. | $\Delta F \leq 5\text{PPM}$ |
| B | FREQUENCY CHANGE PERMITTED. | $\Delta F \leq 10\text{PPM}$ |
| C | EQUIVALENT SERIES RESISTANCE CHANGE PERMITTED. | $\Delta CI \leq 5\Omega$ or 15% |
| D | INSULATION RESISTANCE | $> 500\text{M}\Omega$ |
| E | PRESSURE GAP LESS THAN | $< 1 \cdot 10^{-4} \text{ Pa} \cdot \text{m}^3 / \text{sec}$ |
| F | LEAK RATE LESS THAN | $< 1 \cdot 10^{-9} \text{ Pa} \cdot \text{m}^3 / \text{sec}$ |
| G | A NEW UNIFORM COATING OF SOLDER SHALL COVER A MINIMUM 95% OF THE SURFACE | |
| H | THEN $25 \pm 2^\circ\text{C}$ OVER 2Hr BEFORE TESTING | |

Remark:

※ Each test done independently

※ Measurement condition: Electrical characteristics measured by S&A250B or equivalent.

地址：湖北省随州市经济开发区深圳工业园

ADD: SHENZHEN INDUSTRIAL PARK, SUZHOU ECONOMIC DEVELOPMENT ZONE, HUBEI

SALES TEL: 0722-7509016, FAX: 0722-7509036 URL: www.sztkd.com

FMT: TH-QW-RD2-23 Ver: C0



9. 工艺流程图 FLOW CHART

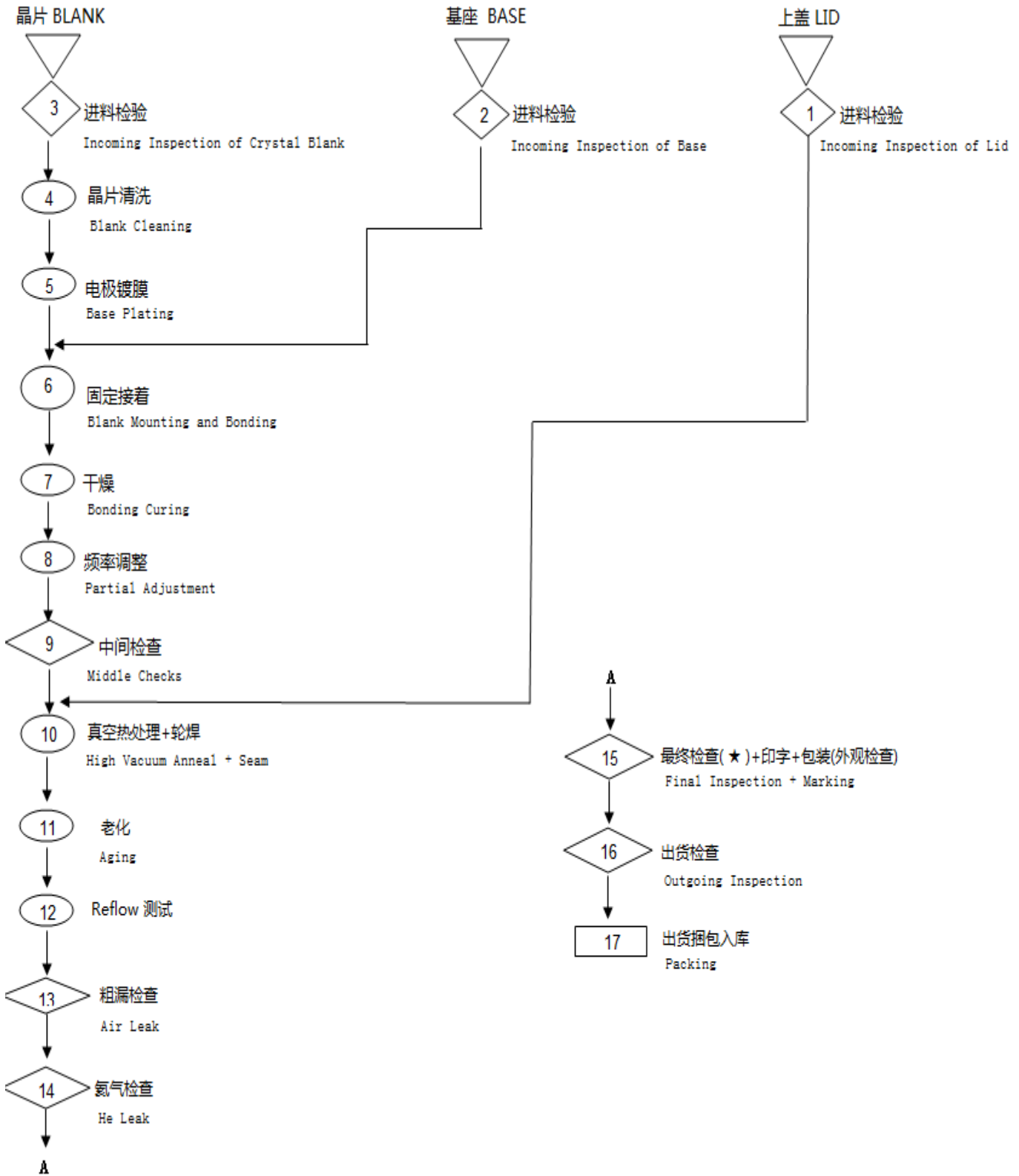

地址：湖北省随州市经济开发区深圳工业园

ADD: SHENZHEN INDUSTRIAL PARK, SUIZHOU ECONOMIC DEVELOPMENT ZONE, HUBEI

SALES TEL: 0722-7509016, FAX: 0722-7509036 URL: www.sztkd.com

FMT: TH-QW-RD2-23 Ver:C0



10. 有害物质含量声明 HARMFUL SUBSTANCE CONTENT STATEMENT

随州泰华电子科技有限公司 SX-3225 产品

有毒有害物质或元素的名称及含量表

| 材料名称 | 有毒有害物质或元素 | | | | | | 备注 |
|-----------|-----------|--------|--------|---------------|------------|--------------|----|
| | 铅 (Pb) | 汞 (Hg) | 镉 (Cd) | 六价铬 (Cr (VI)) | 多溴联苯 (PBB) | 多溴二苯醚 (PBDE) | |
| BLANK | ND | ND | ND | ND | ND | ND | |
| Package | ND | ND | ND | ND | ND | ND | |
| LID | ND | ND | ND | ND | ND | ND | |
| Electrode | ND | ND | ND | ND | ND | ND | |
| Adhesive | ND | ND | ND | ND | ND | ND | |
| | | | | | | | |
| | | | | | | | |
| | | | | | | | |
| | | | | | | | |
| | | | | | | | |
| 拆分部件 n | | | | | | | |

○：表示该有毒有害物质在该部件所有均质材料中的含量均在 SJ/T11363-2006 规定的限量要求以下
 ×：表示该有毒有害物质至少在该部件的某一均质材料中的含量超出SJ/T11363-2006 规定的限量要求。
 (供应商应将其原材料按要求进行拆分，并按照此表格进行详细标注,对不能满足标准要求的零部件进行具体的原因描述)