

1200V , 40A , Trench-FS IGBT

Features

- ◆ Advanced Trench +FS (Field Stop) IGBT technology
- ◆ Low Collector-Emitter Saturation voltage, typical data is 1.8V @ 40A.
- ◆ Short-Circuit withstand time-10uS
- ◆ Easy parallel switching capability due to positive Temperature coefficient in Vce.
- ◆ Fast switching
- ◆ High input impedance
- ◆ Pb- Free product

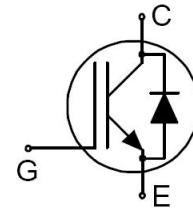

Schematic Diagram

Applications

- ◆ General purpose inverters
- ◆ Welding
- ◆ Motor controls
- ◆ Induction Heating
- ◆ UPS

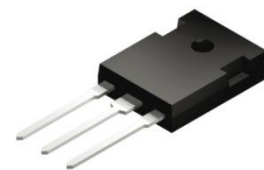

TO-247

Absolute Max Ratings(T_J = 25°C unless otherwise noted)

Symbol	Parameter	Units	Maximum
V _{CES}	Collector-to-Emitter Voltage	V	1200
V _{GES}	Gate to Emitter Voltage	V	± 30
I _C @ TC = 25°C	Collector current @T _c = 25 °C	A	80
I _C @ TC = 100°C	Collector Current @T _c = 100 °C	A	40
I _{CM}	Pulsed Drain Current ^②	A	160
I _F @ TC = 25°C	Diode continuous forward current	A	80
I _F @ TC = 100°C	Diode continuous forward current	A	40
I _{FM}	Diode maximum forward current	A	160
P _D	Power Dissipation @T _c = 25 °C	W	480
	Power Dissipation @T _c = 100 °C	W	240
T _J	Operating Junction Temperature Range	°C	-50 to + 175
T _{STG}	Storage Temperature Range	°C	-50 to + 175
T _L	Maximum Temperature of Soldering	°C	260
R _{θJC}	Maximum Junction-to-Case ^①	°C/W	0.31
R _{θJA}	Maximum Junction-to-Ambient ^②	°C/W	40

- ① These curves are based on the junction-to-case thermal impedance which is measured with the device mounted to a large heat sink, assuming maximum junction temperature of $T_{J(MAX)}=175^{\circ}C$.
- ② The $R_{\theta JA}$ is the sum of the thermal impedance from junction to case $R_{\theta JC}$ and case to ambient.

Electrical characteristics(TJ = 25°C unless otherwise noted)						
Symbol	Parameter	Test conditions	Units	Min.	Typ.	Max.
$V_{(BR)CES}$	Collector - Emitter breakdown voltage	$V_{GE} = 0V, I_D = 0.5mA$	V	1200	—	—
$V_{CE(sat)}$	Collector-Emitter Saturation voltage	$V_{GE}=15V, I_C=40A, T_C=25^{\circ}C$	V	—	1.8	2.3
		$V_{GE}=15V, I_C=40A, T_C=125^{\circ}C$	V	—	1.95	—
$V_{GE(th)}$	Gate threshold voltage	$V_{GE}= V_{CE}, I_D = 0.4mA$	V	4.0	-	6.5
V_F	Diode Forward voltage	$I_C=40A$	V	—	2.2	2.8
I_{GES}	Gate to Emitter Forward Leakage	$V_{ge}=+30V$	nA	—	—	200
I_{GESR}	Gate to Emitter reverse Leakage	$V_{ge}=-30V$		-200	—	—
I_{CES}	Zero gate voltage collector current	$V_{CE} = 1200V$	uA	—	—	100

Dynamic characteristics(T _J = 25°C unless otherwise noted)						
Symbol	Parameter	Test conditions	Units	Min.	Typ.	Max.
C _{iss}	Input capacitance	V _{GE} = 0V V _{CE} = 25V f = 1MHz	pF	—	2480	—
C _{oss}	Output capacitance			—	240	—
C _{rss}	Reverse transfer capacitance			—	125	—
Q _g	Total gate charge	I _C =40A, V _{CE} =600V, V _{GE} =15V	nC	—	192	—
Q _{ge}	Gate-to-Emitter charge			—	16	—
Q _{gc}	Gate-to-Collector("Miller") charge			—	78	—
T _{d(on)}	Turn-On DelayTime	T _J =25°, V _{CC} =600V, I _C =40A, R _G =10ohm, V _{GE} =15V	ns	—	35	—
T _r	Rise Time			—	30	—
T _{d(off)}	Turn-Off DelayTime			—	310	—
T _f	Turn-Off Fall Time			—	100	—
E _{on}	Turn-on switch loss		mJ	—	3.3	—
E _{off}	Turn-off switch loss		mJ	—	2.1	—
t _{rr}	Diode Reverse Recovery Time	I _F = 40 A, V _{GE} = 0 V, di/dt = -20 A/μs	ns	—	260	—
Q _{rr}	Diode Reverse Recovery Charge		nC	—	3050	—
SCSOA	Short Circuit Safe Operation Area	V _{CC} =600V, R _G =25 Ω, V _G =15V to 0V	uS	10		—

Typical electrical and thermal characteristics:

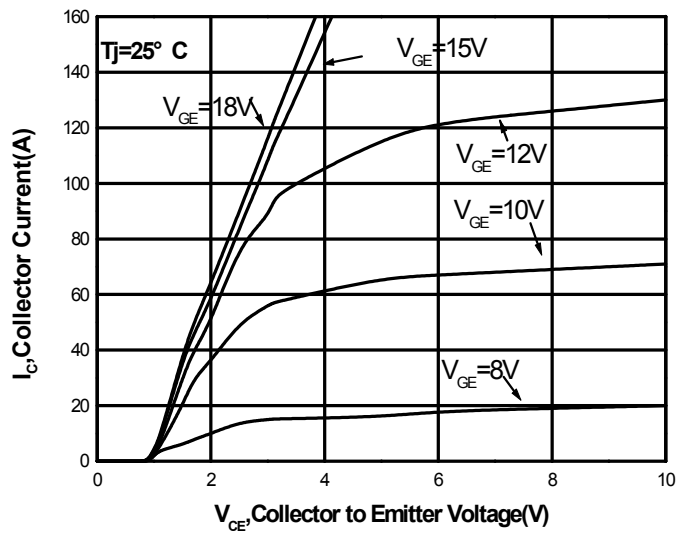

Figure 1: Typical Output Characteristics
($T_J=25^{\circ}\text{C}$)

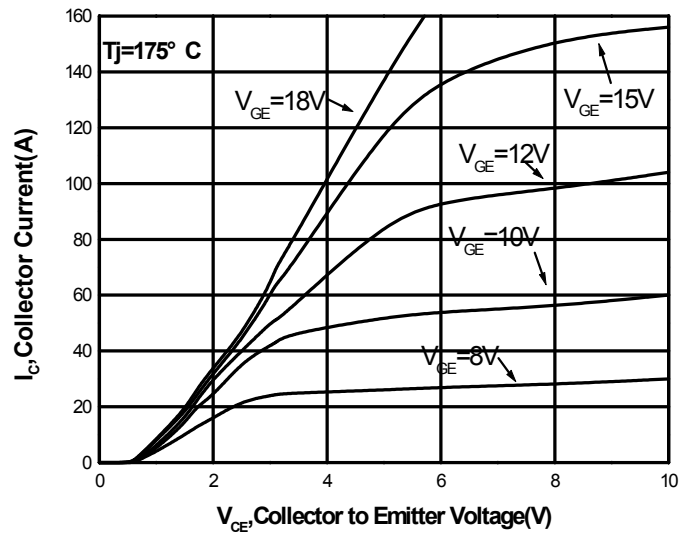

Figure 2: Typical Output Characteristics
($T_J=175^{\circ}\text{C}$)

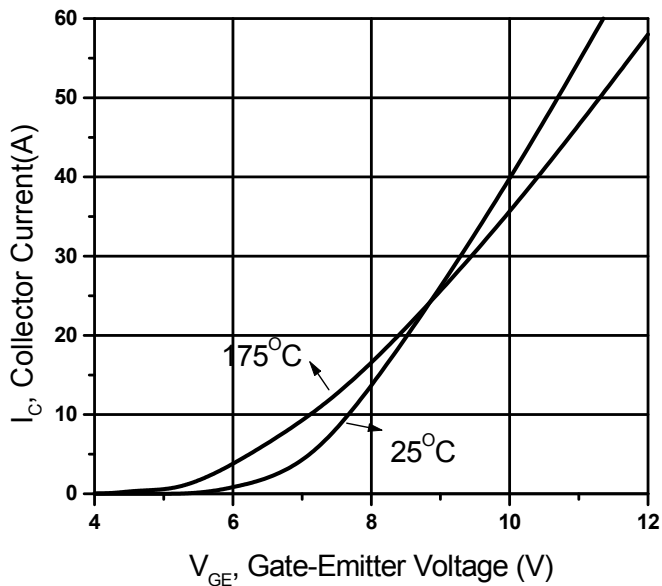

Figure 3: Typical Transfer Characteristics

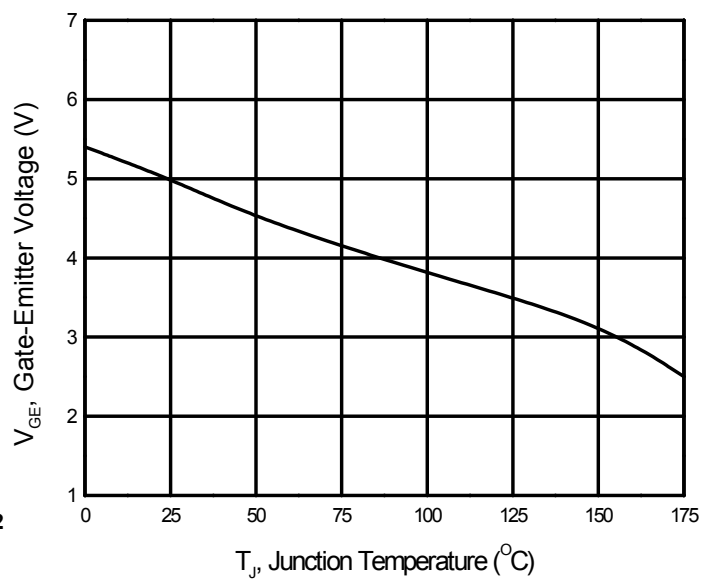

Figure 4: Gate to Emitter threshold Voltage
as a function of T_J

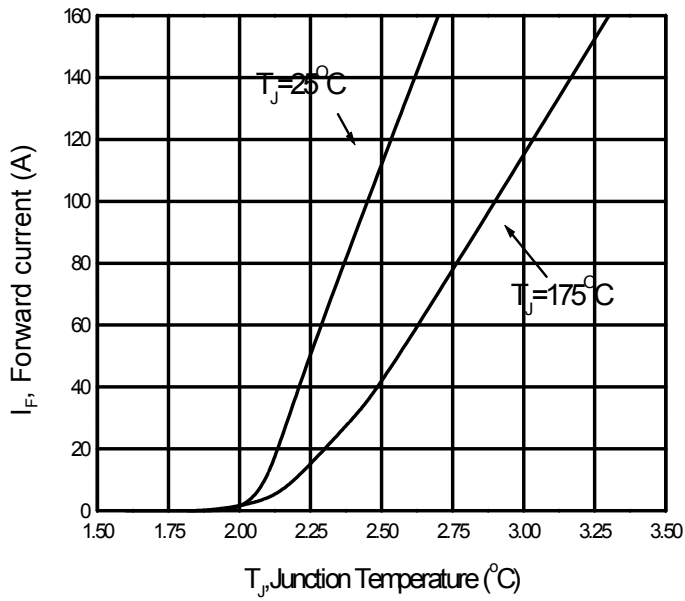

Figure 5: Typical Diode Forward Characteristics

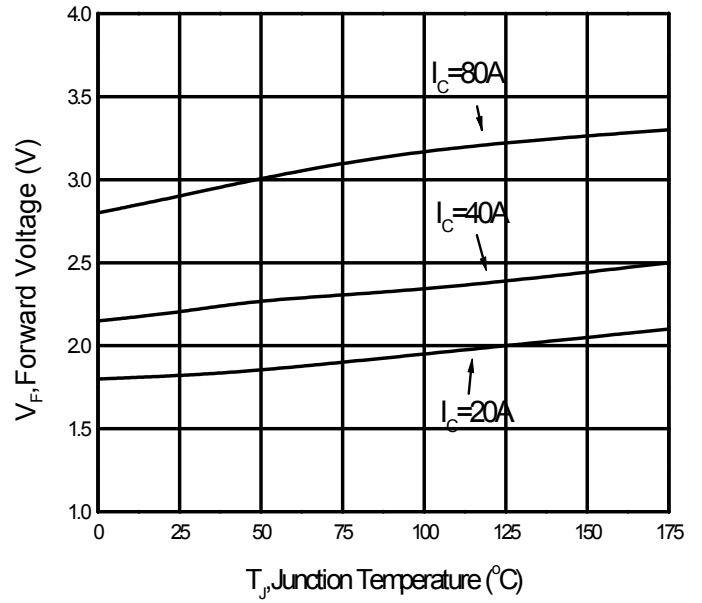

Figure 6: Forward Voltage as a function of T_J

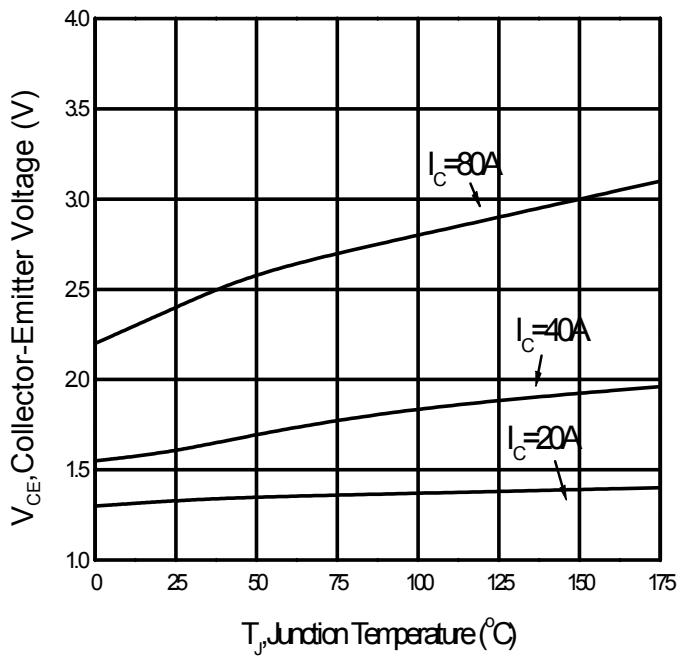

Figure 7: Typical $V_{CE(sat)}$ as a Function of T_J

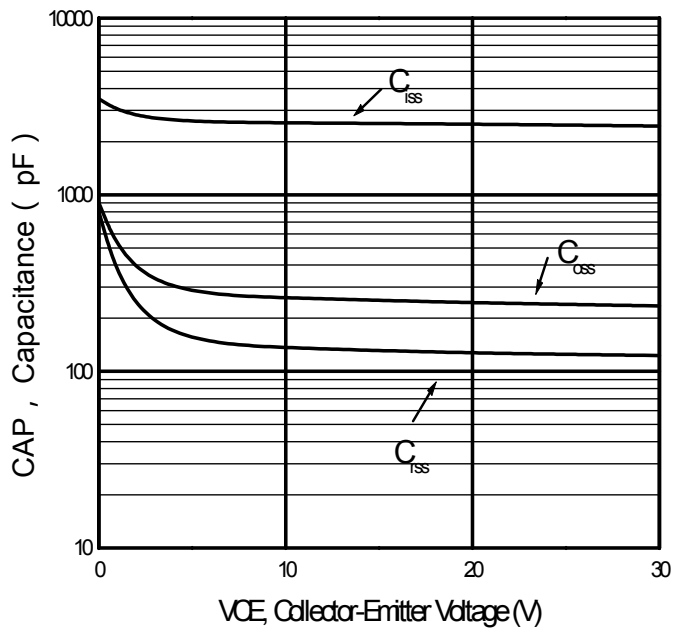

Figure 8: Capacitance Characteristics

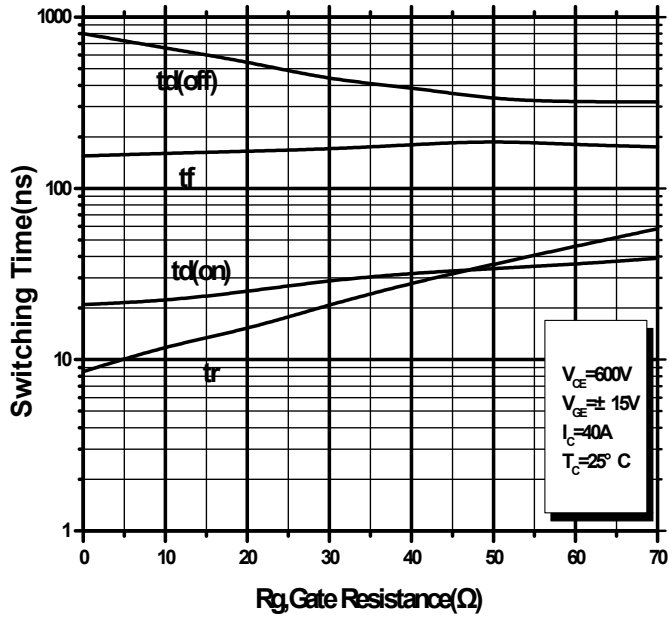

Figure 9: Switching Time Vs R_g

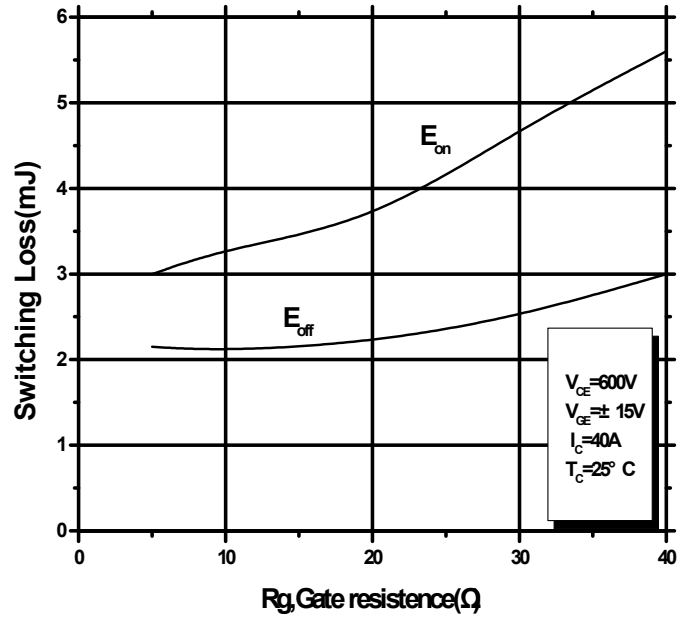

Figure 10: Switching Loss Vs R_g

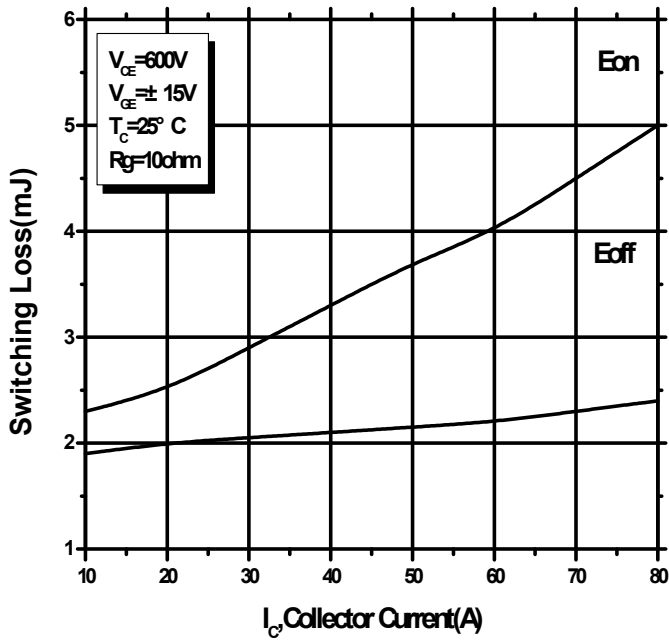

Figure 11: Switching Loss Vs I_C

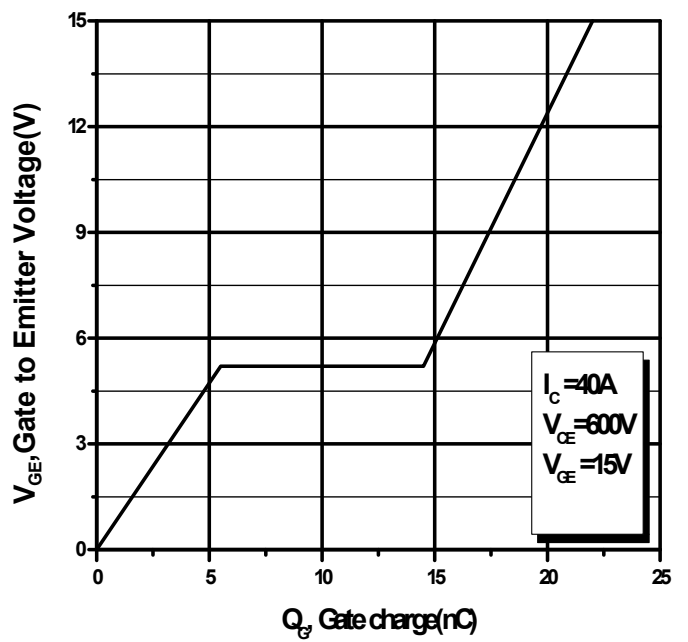

Figure 12: Gate Charge Characteristics

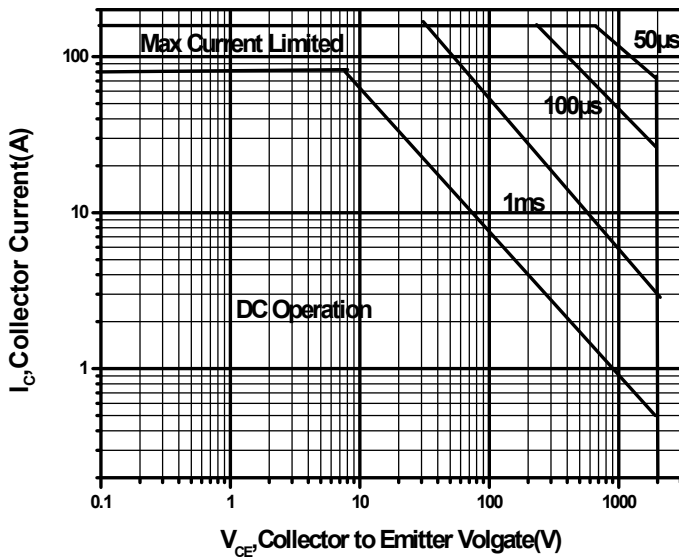

Figure 13: Maximum Forward Biased Safe Operating Area

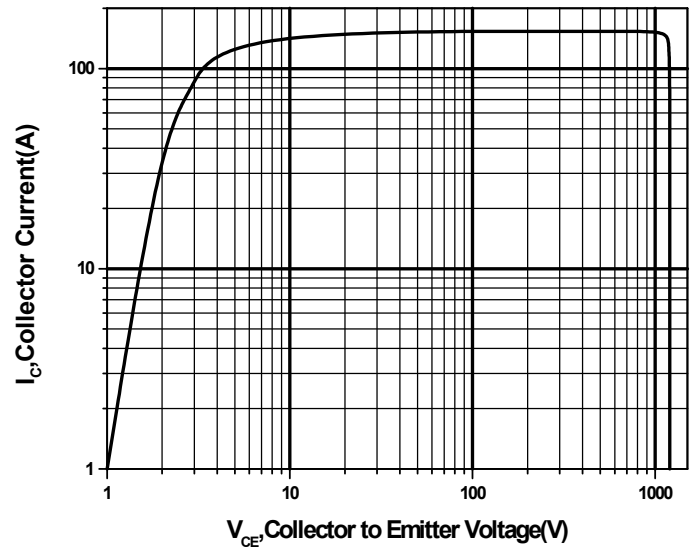

Figure 14: Turn Off Safe Operating Area

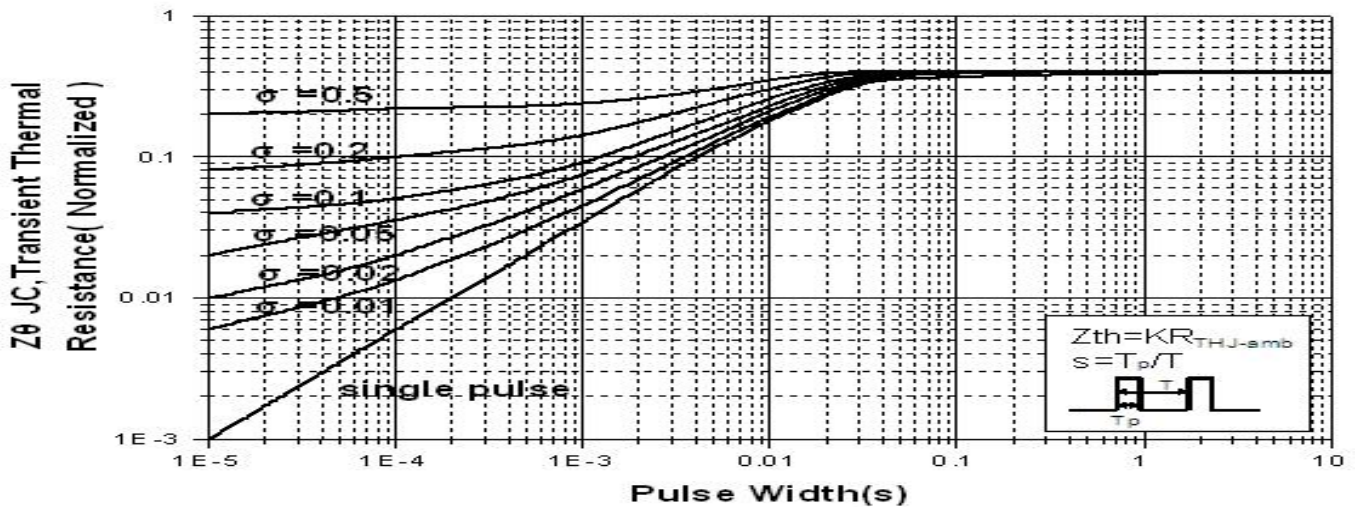
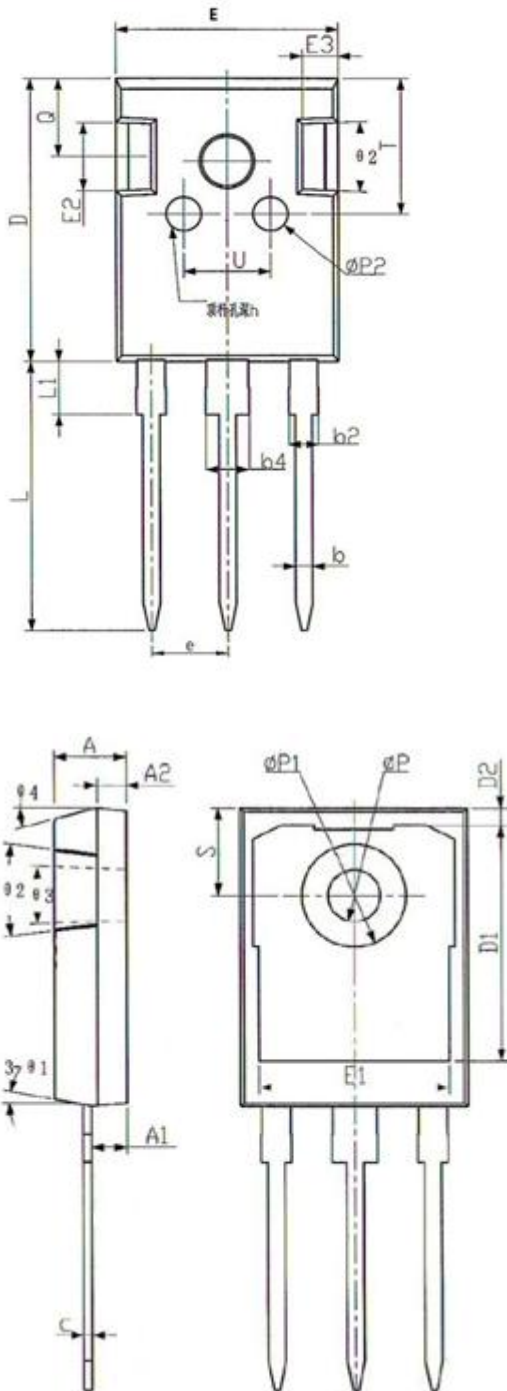

Figure 15: Normalized Maximum Transient Thermal Impedance

Mechanical Data: TO-247



Dimensions			
Symbol	unit:mm		
	Min	Typ	Max
A	4.90	5.00	5.10
A1	2.31	2.41	2.51
A2	1.90	2.00	2.10
b	1.16	1.21	1.26
b2	1.96	2.01	2.06
b4	2.96	3.01	3.06
c	0.59	0.61	0.66
D	20.90	21.00	21.10
D1	16.25	16.55	16.85
D2	1.05	1.20	1.35
E	15.70	15.80	15.90
E1	13.10	13.30	13.50
E2	4.90	5.00	5.10
E3	2.40	2.50	2.60
e	5.44BSC		
h	0.05	-	0.20
L	19.80	19.92	20.01
L1	-	-	4.30
ΦP	3.50	3.60	3.70
ΦP1	-	-	7.30
ΦP2	2.40	2.50	2.60
Q	5.60	5.80	6.00
S	6.15BSC		
T	9.80	-	10.20
U	6.00	-	6.40
θ1	6°	7°	8°
θ2	4°	5°	6°
θ3	1°	-	1.5°
θ4	14°	15°	16°

Published by

ShenZhen Invsemi Co.,Ltd

2nd Floor,Building 8th,Huafeng Cyber Park,9th Baoqing Road,

Longgang District,ShenZhen,China 518119

Tel/Fax: 0755-89890048

All Rights Reserved.

Attention

- Specifications of any and all Invsemi products described or contained herein stipulate the performance, characteristics, and functions of the described products in the independent state, and are not guarantees of the performance, characteristics, and functions of the described products as mounted in the customer's products or equipment. To verify symptoms and states that cannot be evaluated in an independent device, the customer should always evaluate and test devices mounted in the customer's products or equipment.
- Any and all Invsemi products described or contained herein do not have specifications that can handle applications that require extremely high levels of reliability, such as life-support systems, aircraft's control systems, or other applications whose failure can be reasonably expected to result in serious physical and/or material damage. Consult with us described or contained herein in such applications.
- Invsemi assumes no responsibility for equipment failures that result from using products at values that exceed, even momentarily, rated values (such as maximum ratings, operating condition ranges, or other parameters) listed in products specifications of any and all Silikron products described or contained herein.
- Any and all information described or contained herein are subject to change without notice due to product/technology improvement, etc.
- We hereby disclaim any and all warranties, including but not limited to warranties of non-infringement, regarding circuits, descriptions and charts stated herein.