

Chip Infrared LED With Spherical top view Lens LKIR30102C-A02(DY)

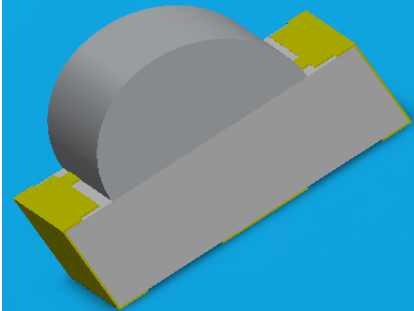

Features

- Small double-end package
- Low forward voltage
- Good spectral matching to Si photo detector
- Pb free
- The product itself will remain within RoHS compliant version
- Compliance with EU REACH
- Compliance Halogen Free .(Br <900 ppm ,Cl <900 ppm , Br+Cl < 1500 ppm).

Descriptions

- LKIR30102C-A02(DY) is an infrared emitting diode in miniature SMD package which is molded in a water clear epoxy with spherical top view lens.
- The device is spectrally matched with silicon photodiode and phototransistor

Applications

- PCB mounted infrared sensor
- Infrared emitting for miniature light barrier
- Floppy disk drive
- Optoelectronic switch
- Smoke detector

Device Selection Guide

| Part Category | Chip Material | Lens Color |
|---------------|---------------|-------------|
| IR | GaAIAs | Water Clear |

Package Dimensions

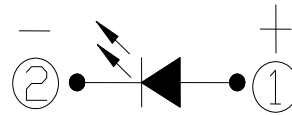
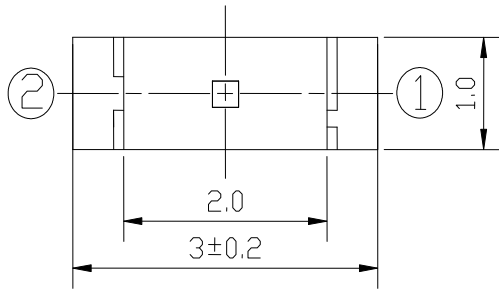

Polarity

- ① Anode
- ② Cathode

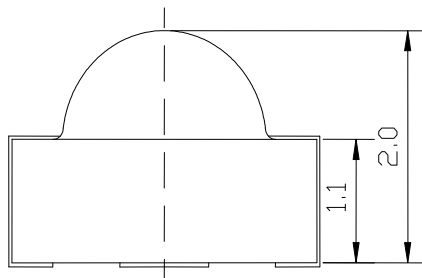

For reflow soldering(propose)

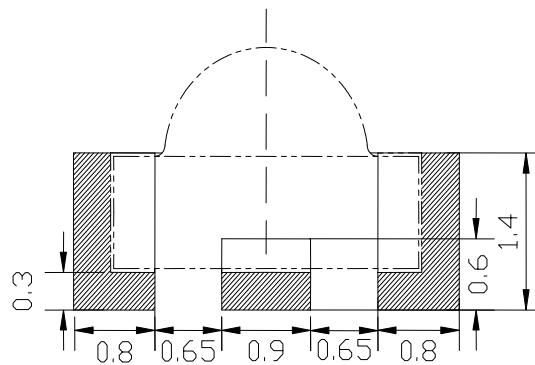
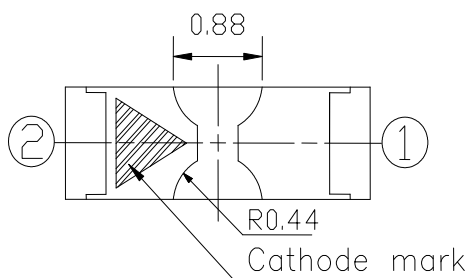

- Notes:**
- 1.All dimensions are in millimeters
 - 2.Tolerances unless dimensions ± 0.1 mm
 - 3.Suggested pad dimension is just for reference only
 Please modify the pad dimension based on individual need

Absolute Maximum Ratings (Ta=25°C)

| Parameter | Symbol | Rating | Units |
|--|------------------|-----------|-------|
| Continuous Forward Current | I _F | 65 | mA |
| Reverse Voltage | V _R | 5 | V |
| Operating Temperature | T _{opr} | -25 ~ +85 | °C |
| Storage Temperature | T _{stg} | -40 ~ +85 | °C |
| Soldering Temperature*1 | T _{sol} | 260 | °C |
| Power Dissipation at (or below) 25°C Free Air Temperature | P _d | 130 | mW |

Notes: *1: Soldering time ≤ 5 seconds

Electro-Optical Characteristics (Ta=25°C)

| Parameter | Symbol | Condition | Min. | Typ. | Max. | Units |
|--------------------|-------------------|----------------------|------|------|------|-------|
| Radiant Intensity | I _e | I _F =20mA | 0.5 | 0.8 | -- | mW/sr |
| Peak Wavelength | λ _p | | -- | 940 | -- | nm |
| Spectral Bandwidth | Δλ | | -- | 45 | -- | nm |
| Forward Voltage | V _F | | -- | 1.2 | 1.5 | V |
| View Angle | 2θ _{1/2} | | -- | 160 | -- | deg |
| Reverse Current | I _R | V _R =5V | -- | -- | 10 | μA |

Typical Electro-Optical Characteristics Curves

Fig.1 Forward Current vs. Ambient Temperature

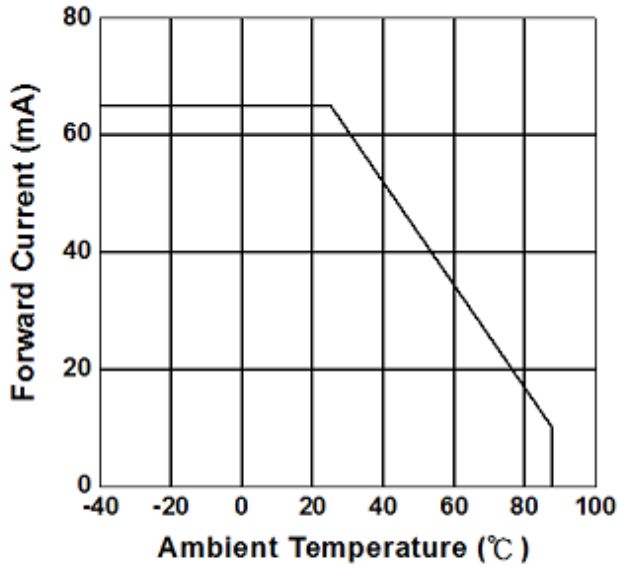

Fig.2 Spectral Distribution

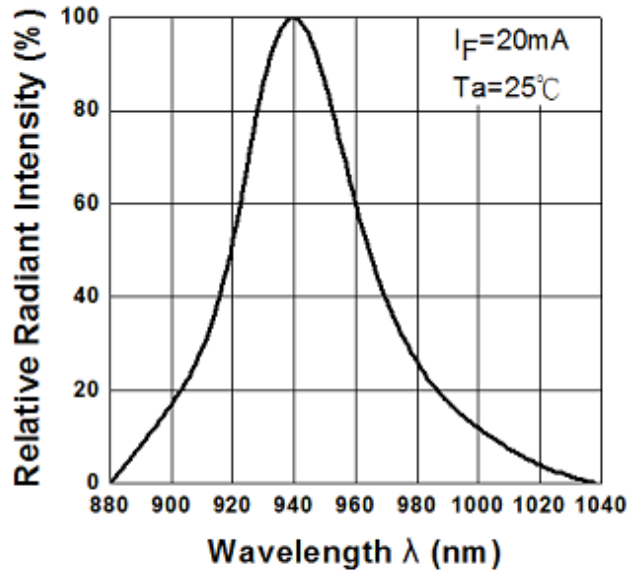

Fig.3 Forward Current vs. Forward Voltage

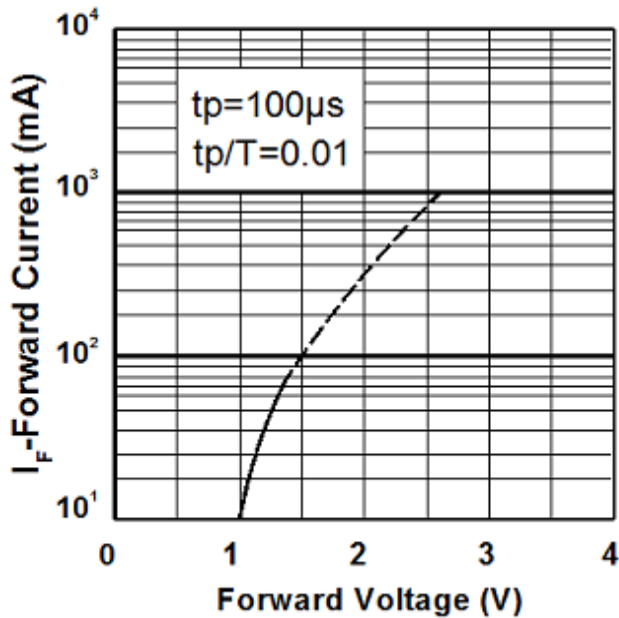
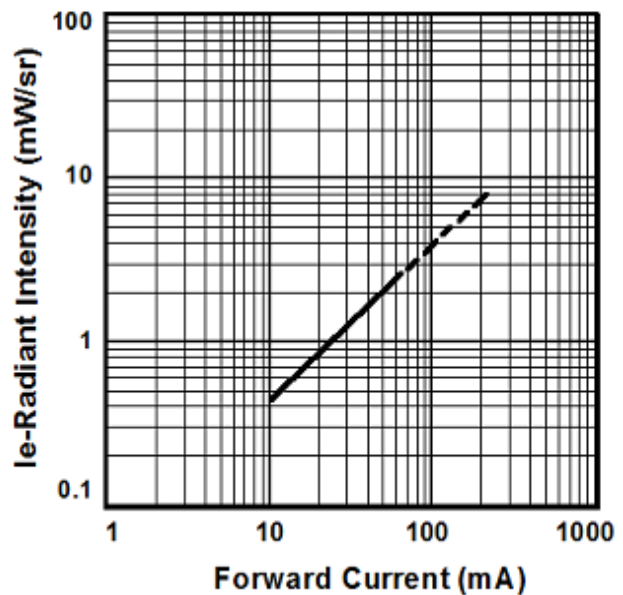
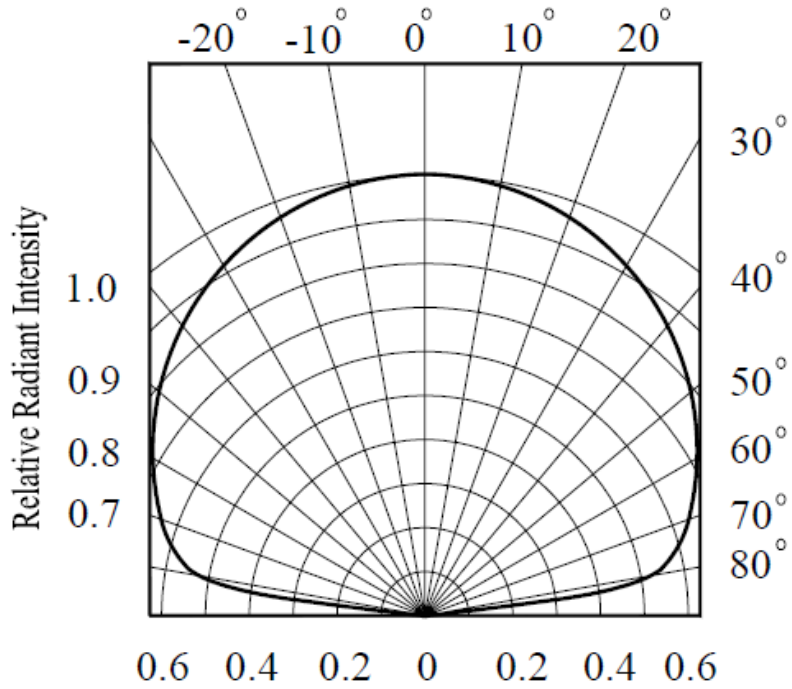

Fig.4 Radiant Intensity vs. Forward Current



Typical Electro-Optical Characteristics Curves

Fig.5 Relative Radiant Intensity vs.
Angular Displacement



Precautions For Use

1. Over-current-proof

Customer must apply resistors for protection, otherwise slight voltage shift will cause big current change (Burn out will happen).

2. Storage

2.1 Do not open moisture proof bag before the products are ready to use.

2.2 Before opening the package, the LEDs should be kept at 10°C ~30°C and 90%RH or less.

2.3 The LEDs suggested be used within one year.

2.4 After opening the package, the devices must be stored at 10°C ~30°C and $\leq 60\%RH$, and used within 168 hours (floor life). If unused LEDs remain, it should be stored in moisture proof packages.

2.5 If the moisture absorbent material (desiccant material) has faded or unopened bag has exceeded the shelf life or devices (out of bag) have exceeded the floor life, baking treatment is required.

2.6 If baking is required, refer to IPC/JEDEC J-STD-033 for bake procedure or recommend the following conditions:

96 hours at 60°C $\pm 5^\circ\text{C}$ and $< 5\% RH$ (reeled/tubed/loose units).

3. Soldering Condition

3.1 Pb-free solder temperature profile

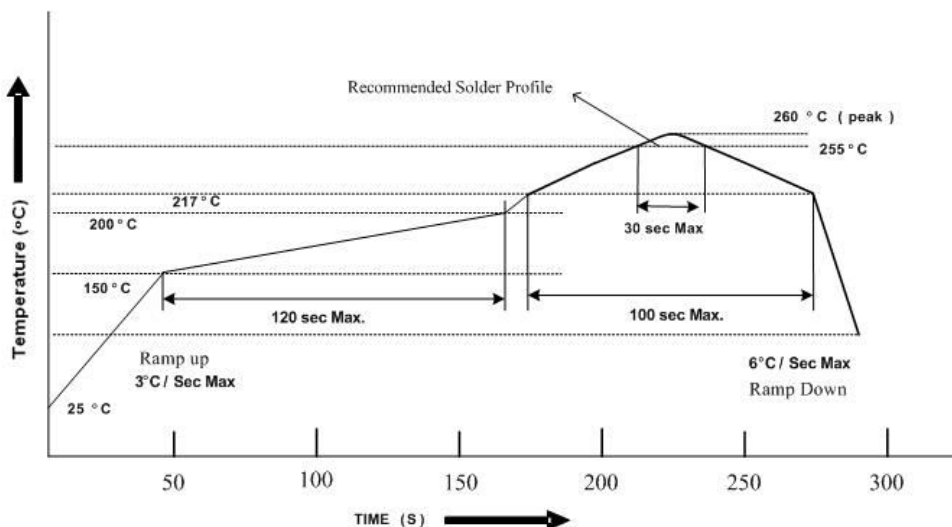

3.2 Reflow soldering should not be done more than two times

3.3 When soldering, do not put stress on the LEDs during heating

3.4 After soldering, do not warp the circuit board

4. Soldering Iron

Each terminal is to go to the tip of soldering iron temperature less than 350°C for 3 seconds within once in less than the soldering iron capacity 25W. Leave two seconds and more intervals, and do soldering of each terminal. Be careful because the damage of the product is often started at the time of the hand solder.

5. Repairing

Repair should not be done after the LEDs have been soldered. When repairing is unavoidable, a double-head soldering iron should be used (as below figure). It should be confirmed beforehand whether the characteristics of the LEDs will or will not be damaged by repairing.

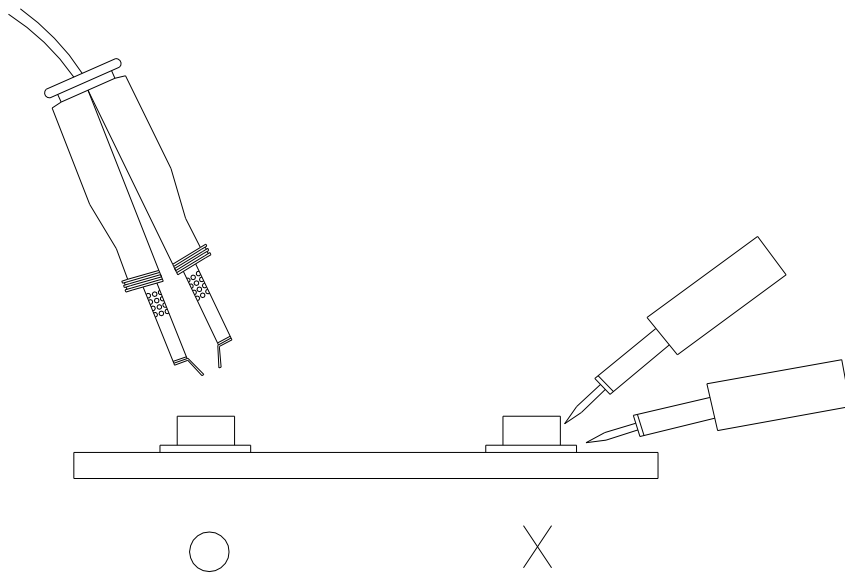

Package Dimensions

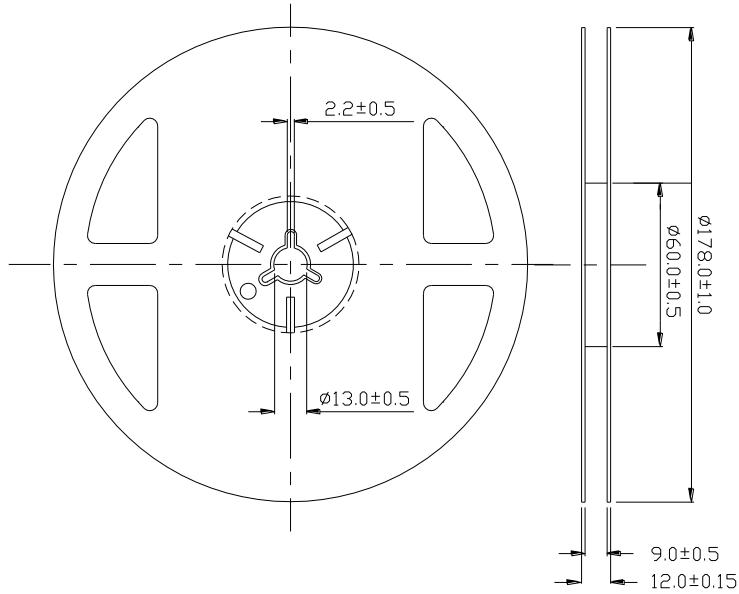





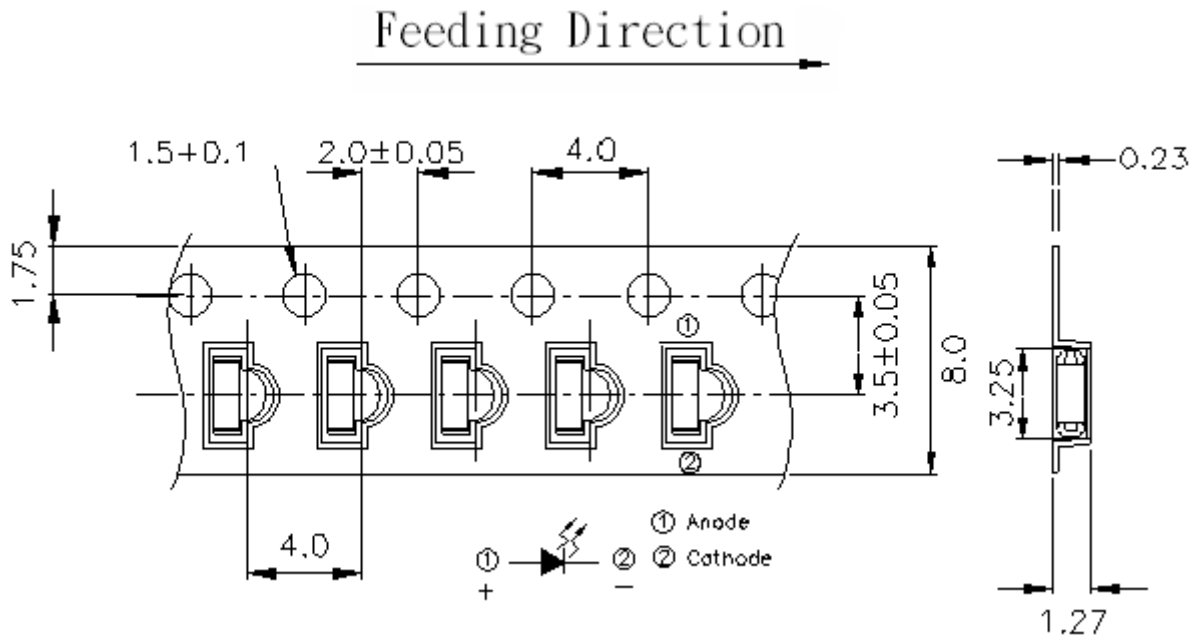



Note: The tolerances unless mentioned are ± 0.1 mm, unit: mm

Carrier Taping Dimensions: (Quantity: 2000PCS/Reel)



Note: The tolerances unless mentioned are ± 0.1 mm, unit: mm

Label Form Specification

| | | | |
|---|---|------------------|---|
| RoHS |  | EVERLIGHT | 5 |
| CPN: XXXXXXXXXXXXXXXXXXXX | | | |
|  | | | |
| XXXXXXXXXX-XXXXXXXXXX-XXXXXXXXXX-XXXXXXXXXX-XXXXXX | | | |
| P/N: XXXXXXXXXXXX | | | |
|  | | | |
| XXXXXXXXXX-XXXXXXXXXX-XXXXXXXXXX-XXXXXXXXXX-XXXXXX | | | |
| LOT NO: Y150716XXX-XXXXXXXXXX-XXXXXXXXXX | | | |
|  | | | |
| QTY: 0123456789 HUE: XXXXXXXXXXXX | | | |
|  | | | |
| CAT: XXXXXXXXXXXX REF: XXXXXXXXXXXX | | | |
|  | | | |
| REFERENCE: BTPYMMDDXXXXX | | | |
|  | | | |
| MSL-X MADE IN XXXXXX | | | |
| | | |  |

CPN: Customer's Production Number

P/N : Production Number

LOT No: Lot Number

QTY: Packing Quantity

HUE: Peak Wavelength

CAT: Ranks

REF: Reference

MSL-X: MSL Level

Made In: Manufacture place

DISCLAIMER

1. EVERLIGHT reserves the right(s) on the adjustment of product material mix for the specification.
2. The product meets EVERLIGHT published specification for a period of twelve (12) months from date of shipment.
3. The graphs shown in this datasheet are representing typical data only and do not show guaranteed values.
4. When using this product, please observe the absolute maximum ratings and the instructions for using outlined in these specification sheets. EVERLIGHT assumes no responsibility for any damage resulting from the use of the product which does not comply with the absolute maximum ratings and the instructions included in these specification sheets.
5. These specification sheets include materials protected under copyright of EVERLIGHT. Reproduction in any form is prohibited without obtaining EVERLIGHT's prior consent.
6. This product is not intended to be used for military, aircraft, automotive, medical, life sustaining or life saving applications or any other application which can result in human injury or death. Please contact authorized Everlight sales agent for special application request.

EVERLIGHT ELECTRONICS CO., LTD.

Office: No. 6-8, Zhonghua Rd., Shulin Dist.,

New Taipei City 23860, Taiwan

Tel: 886-2-2685-6688

Fax: 886-2685-2699 · 6897

<http://www.everlight.com>