



韩国韩荣部品株式会社
东莞市韩荣电子科技有限公司

承 认 书

客 户 CUSTOMER			
客户料号 CUSTOMER MODEL:			
品 名 PART NAME	DC 插座		
型 号 MODEL	DC-005A-25A		
承认单位 DEPT	检验 INSPECT (QC)	审核 CHECK (R&D)	批准 APPD (R&D)
承 认 人 RESPONSIBLE			
判 定 DETERMINE	OK <input type="checkbox"/> NG <input type="checkbox"/>	OK <input type="checkbox"/> NG <input type="checkbox"/>	OK <input type="checkbox"/> NG <input type="checkbox"/>

韩国韩荣部品株式会社

KOREAN HROPARTS ELECTRONICS CO.,LTD

ADD:118-4 Zhen Chen 3 Xin Buk Chun City Gang Won Do Korea

E-mail: kr@krhro.com

东莞市韩荣电子科技有限公司

DONGGUAN HRO ELECTRONICS TECHNOLOGY CO.LTD

TEL: 86-769-87818100 87818200 87818300

FAX: 86-769-87818500

Http:www.krhro.com

E-mail:sales@krhro.com

ADD: 中国广东省东莞市塘厦镇 138 工业区宏业北二横路 1 号

本厂工程部审核:

ENGINEERING DEPT:

东莞市韩荣电
子科技有限
公司工程部

日期: 2019 年 04 月 04 日

RoHS

让客户 100%满意的高品质开关插座供应商

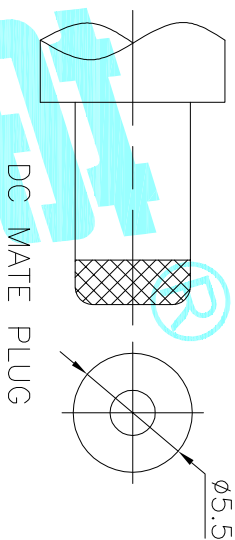
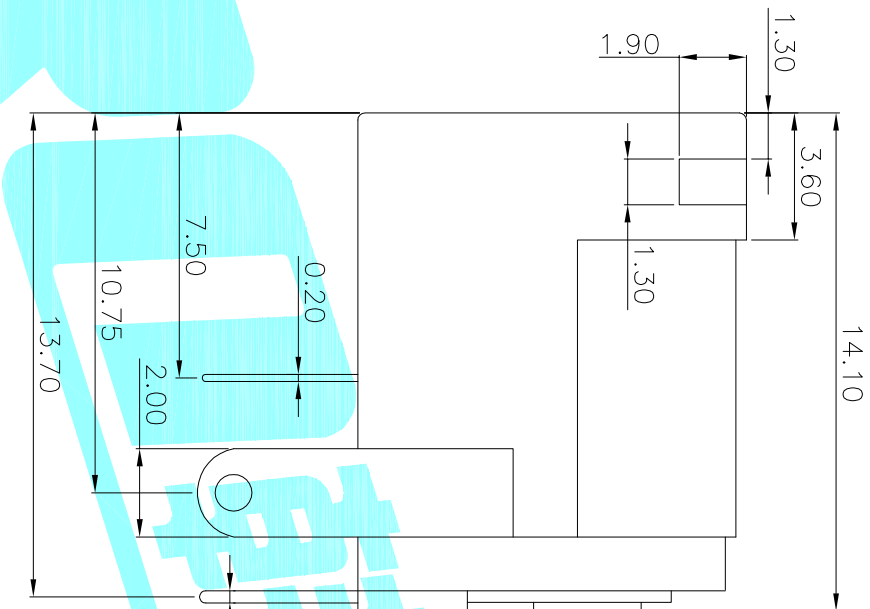
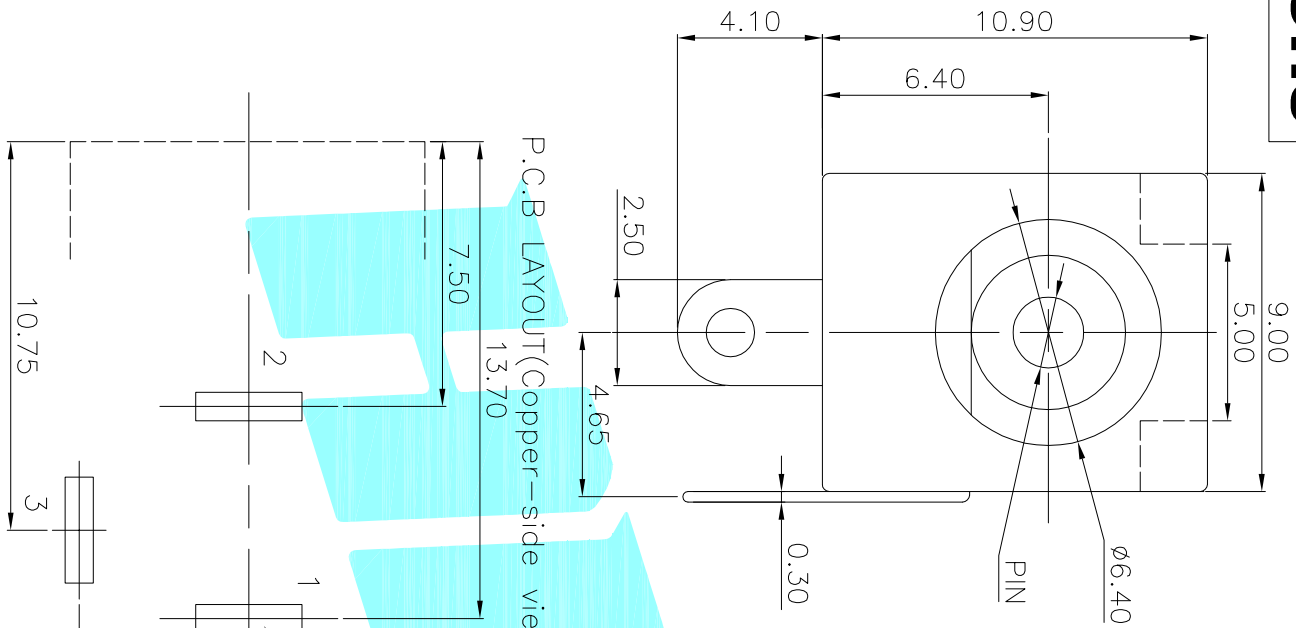

P.C.B LAYOUT(Copper—side view)

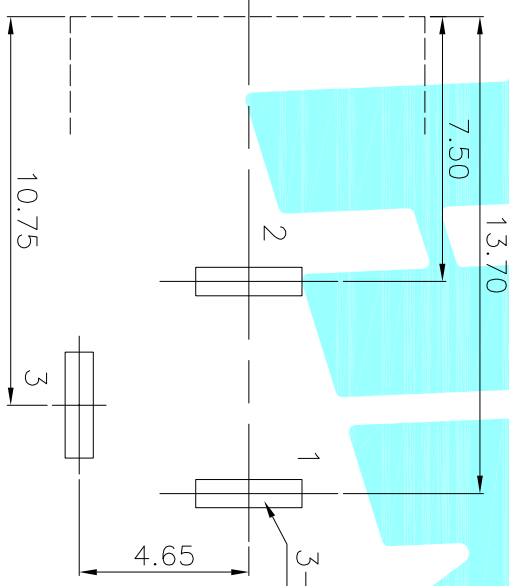

Rating:0.5A 30V DC
 Contact Resistance:100 mΩ Max.
 Operating temperature: -20℃~70℃
 Operating force:3~20N
 Operating Life:5,000cycles

Model No.	1	2	3
PIN	∅2.0	∅2.35	∅2.5

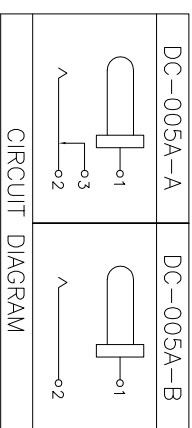

② Terminal	—	X	Phosphor bronze	—		
① Housing	—	1	Nylon	Black		
ITEM	PART NAME	TER.NO.	QTY.	MATERIAL	FINISHING	REMARK
APPROVALS		DATE	ELECTRONICS CO.,LTD			
DRAWN		J.X.Zhong	2013/11/11	TITLE: PHONE JACKES		
CHECKED				PART NO. DC-005A		
APPROVALS				SCALE: 1:1		
TOLERANCES ARE		30~0.1±	±0.30	ANGLE	PROJ:	
		10~0.30	±0.20	UNIT: mm	SHEET 1 OF 1	
		5~0.10	±0.15	DRAWING NO.		
		~5	±0.10			

ECN NO.	REV.	DATE.	DESCRIPTION.	CHANGE.	CHECK.	APPRO.
	A		NEW			

 KOREAN HROPARTS ELECTRONICS CO.,LTD		文件编号 FILE NO.	HR-SPEC-003	页码 PAGE	1/5
		发布日期 DATE OF ISSUE	2016年10月09日		
PRODUCT SPECIFICATION 产品承认书		文件版本 EDITION	第 A 版 第 3 次修订		
Title 名称	DC 插座 DC POWER JACKES	产品料号 PART NO.	DC 系列		

1. General specification 基本事项

- 1.1 action : DC POWER JACKES
种类 : DC 插座
- 1.2 Switch rating 最大额定值 : D. C. 30V , 50 mA
- 1.3 Operation temperature range 使用温度试验范围 : - 25~ + 80°C
- 1.4 Preservative temperature range 保存温度范围 : - 30~ + 85°C
- 1.5 Appearance and dimensions : See outside drawing page
外形及尺寸 : 见外形尺寸图
- 1.6 General test condition (Tests and measurements shall be made under the following standard conditions unless otherwise specified): 正常测试条件(未有特殊说明量测在以下条件进行):
- Ambient temperature 温度: 5 ~ 35°C
- Relative humidity 相对湿度: 45 ~ 85%RH
- Air pressure 气压: 86 ~ 106kPa (860~1060mbar)
- However, if doubt arises on the decision based on the measured Values under the above-mentioned conditions, the following conditions shall be employed:
但是在对判定产生疑义时,按下述状态实施:
- Ambient temperature 温度: 20±2°C
- Relative humidity 相对湿度: 65±5%
- Air pressure 气压: 86 ~ 106kPa (860~1060mbar)

2. Performance 性能

2.1 Electrical characteristics 电气性能

NO.	Item 项目	Test condition 试验条件	Performance 规格
2.1.1	Contact resistance 接触电阻	Measured at low current(10mA or less) 在低电流 (≦10MA) 条件下测试	100mΩ MAX 100mΩ 以下
2.1.2	Insulation resistance 绝缘电阻	Measurement shall be made between adjacent terminals, between terminal and shell(DC 500V) 测试相邻引脚之间, 引脚与外壳之间的绝缘阻抗(DC 500V)	100MΩ min 100MΩ 以上
2.1.3	Withstand voltage 耐电压	Apply certain voltage (50-60Hz , AC 500V) for 1 minute between adjacent contacts of the connector with 0.5mA Leakage sensitivity. 输入一定电压(50-60Hz ,电压值 AC 500V)1分钟,漏电流为 0.5mA ,测试邻近端子间	No. insulation destruction. 无绝缘破坏

2.2 Mechanical Characteristics 机械性能

2.2.1	Insertion & Extraction Force 插拔力	Products mated 3 cycles, fix the species in the force gauge and test the mating force of the connector . 产品插拔三次后,置于插拔力测试计上测试插入力和拔出力.	2.94-29.4 N. (0.3Kg-3Kg)
-------	----------------------------------	-----------------------------------------------------------------------------------------------------------------------------------------	-----------------------------

 KOREAN HROPARTS ELECTRONICS CO.,LTD		文件编号 FILE NO.	HR-SPEC-003	页码 PAGE	2/5
		发布日期 DATE OF ISSUE	2016年10月09日		
PRODUCT SPECIFICATION 产品承认书		文件版本 EDITION	第 A 版 第 3 次修订		
Title 名称	DC 插座 DC POWER JACKES	产品料号 PART NO.	DC 系列		

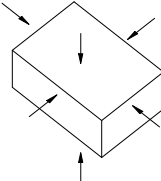
NO.	Item 项目	Test condition 试验条件	Performance 规格
2.2.2	Load Strength of Terminal 端子强度	Apply 0.5Kg load to terminal of the connector in any direction for 1 minute. 于连接端子处上方垂直施加0.5Kg的力，持续时间1分钟。	Terminal shall be not broken off, rupture, looseness and other defects. 端子无变形，断裂，等异常。
2.2.3	Conditions for reflow 回流焊焊接	Soldering area: t/2 of P.W.B. thickness (P.W.B:T=1.6) 焊接面积：印刷基板的1/2 厚度处 (P.W.B:T=1.6) Soldering temperature : 250± 5°C 焊接温度： 250± 5°C soldering time : 5 ±1s 焊接时间： 5 ±1 秒 【适用于贴片式产品】	No damage (electrical and mechanical) 无异常。 (电气、机械特性)
2.2.4	Wave-soldering 波峰焊焊接	Terminals shall be dipped in the solder bath at 250±5°C for 3-5s (seconds without additional force for terminals) 端子焊接部分浸入焊炉，锡炉温度 250±5°C，焊接时间 3-5 秒。(焊接时不可于端子施加外力)。 插件物料手工焊接时需保证烙铁设置温度在 350°C 内，焊接时间 3 秒内，烙铁头接触引脚与元件本体距离要求为 2~4MM 之间； 【适用于插件式产品】	No damage (electrical and mechanical) 无异常。 (电气、机械特性)
2.2.5	Solderability 可焊性	After sprated flux 涂上助焊剂后 temperature :235± 5°C 温度： 235± 5°C soldering time :2±0.5 sec 焊接时间： 2±0.5 秒	90% or more of surface area of the portion immersed in solder shall be covered by new solder 90% 或更多的浸焊面积能被焊锡覆盖。
2.2.6	Shock 耐冲击性	Measure after test at a condition below 在下列条件下进行测试后的量度 Peak acceleration----80G 冲击加速度-80G Test time-6direction ,each 3 times total 18times 测试次数-6 个方向，各3 次共计18 次。 	No.2.1 and 2.2.1 to 2.2.2 shall be satisfied 第2.1 及2.2.1—2.2.2 都应符合要求

 KOREAN HROPARTS ELECTRONICS CO.,LTD		文件编号 FILE NO.	HR-SPEC-003	页码 PAGE	3/5
		发布日期 DATE OF ISSUE	2016年10月09日		
PRODUCT SPECIFICATION 产品承认书		文件版本 EDITION	第A版 第3次修订		
Title 名称	DC插座DC POWER JACKES	产品料号 PART NO.	DC系列		

2.3 Durability characteristics 耐久性

NO.	Item 项目	Test condition 试验条件	Performance 规格
2.3.1	Endurance (switching action) 耐久特性 (开关寿命)	Switch shall be operated continuously at 20~50 cycles /5000 times. 开关在寿命试验设备上以 20~50 次 / 分的速度连续被操作,5000 次。	After test, Insulation resistance: 10MΩ Min 实验后: 绝缘电阻: 10MΩ Min Insertion & Extraction Force: 2.94-29.4 N (0.3-3Kg) 插拔力: 2.94~29.4 N (0.3-3Kg)

2.4 Climatic characteristics 耐候性能

No.	Item 项目	Test condition 试验条件	Performance 规格
2.4.1	Cold test 耐寒性	(1) Temperature : - 20±2℃ 温度: - 20±2℃ (2) Duration of test: 96h 持续时间: 96 小时 (3) Take off a drop water 去掉水珠 (4) Standard conditions after test : 1h 试验后的放置条件: 1 小时	Contact resistance 100 mΩ max No. 2.1.2 to 2.1.4 and No. 2.2.1 to 2.2.2 shall Be satisfied 接触电阻 100 mΩ 以下 满足2.1.2 到2.1.4 项、2.2.1到 2.2.2 项.
2.4.2	Heat test 耐热性	(1) Temperature : 80±2℃ 温度: 80±2℃ (2) Duration of test: 96h 持续时间: 96 小时 (3) Standard conditions after test : 1h 试验后的放置条件: 1 小时	Contact resistance 50mΩ max No. 2.1.2 to 2.1.4 and No. 2.2.1 to 2.2.2 shall Be satisfied 接触电阻 100mΩ以下 满足2.1.2 到2.1.4 项2.2.1到 2.2.2 项.

 KOREAN HROPARTS ELECTRONICS CO.,LTD		文件编号 FILE NO.	HR-SPEC-003	页码 PAGE	4/5													
		发布日期 DATE OF ISSUE	2016年10月09日															
PRODUCT SPECIFICATION 产品承认书		文件版本 EDITION	第 A 版 第 3 次修订															
Title 名称	DC 插座 DC POWER JACKES	产品料号 PART NO.	DC 系列															
NO.	Item 项目	Test condition 试验条件		Performance 规格														
2.4.3	Temperature cycle 温度循环	(1) Test cycles :20 cycles 试验周期: 20 个周期 (2) Standard condition after test :1h 试验后的放置条件: 1 小时 <table border="1" data-bbox="419 607 1023 864"> <thead> <tr> <th></th> <th>temperature 温度</th> <th>duration of test 持续时间</th> </tr> </thead> <tbody> <tr> <td>1 cycle 一次</td> <td>20±5℃</td> <td>1h</td> </tr> <tr> <td rowspan="3">循环</td> <td>-25±2℃</td> <td>1h</td> </tr> <tr> <td>20±5℃</td> <td>1h</td> </tr> <tr> <td>80±5℃</td> <td>1h</td> </tr> </tbody> </table>			temperature 温度	duration of test 持续时间	1 cycle 一次	20±5℃	1h	循环	-25±2℃	1h	20±5℃	1h	80±5℃	1h	No damage Electricalandmechanical 无异常 电气、机械性能	
	temperature 温度	duration of test 持续时间																
1 cycle 一次	20±5℃	1h																
循环	-25±2℃	1h																
	20±5℃	1h																
	80±5℃	1h																
2.4.4	Humidity test 耐湿性	(1) Temperature : 40±2℃ 温度: 40±2℃ (2) relative humidity: ≤85% RH 相对湿度: ≤85% RH (3) Duration of test: 96h 持续时间: 96 小时 (3) Take off a drop water 去掉水珠 (4) Standard conditions after test : 1h 试验后的放置条件: 1 小时		Contact resistance 50mΩ max No. 2.1.2 to 2.1.4 and No. 2.2.1 to 2.2.2 shall Be satisfied 接触电阻 50mΩ以下 满足2.1.2 到2.1.4 项、2.2.1 到2.2.2 项.														
2.4.5	Salt mist Test 盐雾实验	The switch shall be subjuted to a fime mist of salt solution at a temperature of 35±2℃ for 24H continuously (salt solution concentration 5±1% by weight) 温度: 35±2℃ 浓度: 5±1% 时间: 24H After immersing , salt deposit shall be removed by running water. 试验后, 将盐沉积物用水冲掉		No remarkable corrosion shall be recognized in metal parts 在金属件上没有严重腐蚀斑点														

 KOREAN HROPARTS ELECTRONICS CO.,LTD		文件编号 FILE NO.	HR-SPEC-003	页码 PAGE	5/5
		发布日期 DATE OF ISSUE	2016年10月09日		
PRODUCT SPECIFICATION 产品承认书		文件版本 EDITION	第 A 版 第 3 次修订		
Title 名称	DC 插座 DC POWER JACKES	产品料号 PART NO.	DC 系列		

3. Precaution 注意事项 3.1 Soldering condition 浸焊条件

ITEM项目	CONDITION条件
Preheat temperature 预热温度	110°C max (Embilomental temperature of soldering surface of P. W. E) 110°C 以下(印刷基板焊锡面周围的温度)
Preheat time 预热时间	60 sec, max 60 秒以内
Area of flux 助焊剂的面积	1/2 max of P. W. B. thickness 印刷基板厚度的 1/2 以内
Temperature of solder 焊锡温度	250°C max 250°C 以下
Time of immersion 浸焊时间	Within 5 sec 5 秒以内
Soldering number 浸焊次数	Within 2 times (But should bring down heat of the first soldering) 2 次以内 (但应把第一次焊锡的温度降下来)
Printed wiring board 印刷基板	Single sided copper-clad laminates 单面铜箔

(1) After switches were soldered, please be careful not to clean switches with solvent
开关浸焊后,注意不要用溶剂清洗.

(2) In the case of using soldering iron, soldering conditions shall be 350°C max and 3 sec. max
在使用烙铁的情况下,焊锡温度应在350°C 以下、3 秒以内.

(3) Right after switches were soldered; please be careful not to load on the knobs of switches.
浸焊后,注意不要在顶部施加负荷.

3.2 Design instructions(设计中应注意的事项)

(1) Follow recommended P. W. B. piercing plan in outside drawing page. 印刷基板的安装孔尺寸参见产品图.

(2) Design key top as fig. Design inclination of key top 4 deg. max as fig. (Recommended operating condition.)
击键部设计如图,击键部倾斜度如图在4 度以内.(参见操作条件).

3.3 Note(注意点)

(1) Please be cautious not to give excessive static load or shock to switches.
注意不要施加超负荷的压力或晃动开关.

(2) Please be careful not to pile up P. W. B. after switches were soldered.
开关焊接以后,印刷基板注意不要叠放.

(3) Preservation under high temperature and high humidity or corrosive gas should be avoided
especially. When you need to preserve for a long period, do not open the carton.

保管时尤其应注意避开高湿高温和有腐蚀性气体的环境.如需长时间保存,请不要打开包装箱.

制表: 张海燕 审核: 徐其峰