



# 承认书

## APPROVAL SHEET

客户名称:

Customer

/

产品名称:

Part Name

绕线型片式电感器

Wire Wound Chip inductor

产品规格:

Specification

FHW Series

版本号:

Version No.

18.01

日期:

DATE

2018-5-21

制造 Manufacturer			客户 Customer		
拟制 Draft by	审核 Checked by	确认 Approve by	检验 Check by	审核 Checked by	批准 Approval by
林晓华	徐雪枫	区军沛			



序号 No	目 录 TABLE OF CONTENTS
1	履 历 表 Resume
2	外形尺寸与内部结构 Dimension & Inner-configuration
3	产品品名构成 Product Spec. Model
4	电性能参数表 Electrical Characteristics List
5	可靠性试验项目 Reliability Testing Items
6	产品包装 Packaging
7	推荐焊接条件 Recommend Soldering Conditions
8	清洗 Cleaning
9	存储要求 Storage Requirements
10	ODS（消耗臭氧层物质）的使用情况 Usage Of ODS
11	注意事项 Notes



### 1. 履历表 Resume

版本 Version No.	修改明细 Modify Details	日期 Date
18.01	首次发行 Initial issue	2018-5-21



## 2 外形尺寸与内部结构 Dimension & Inner-configuration:

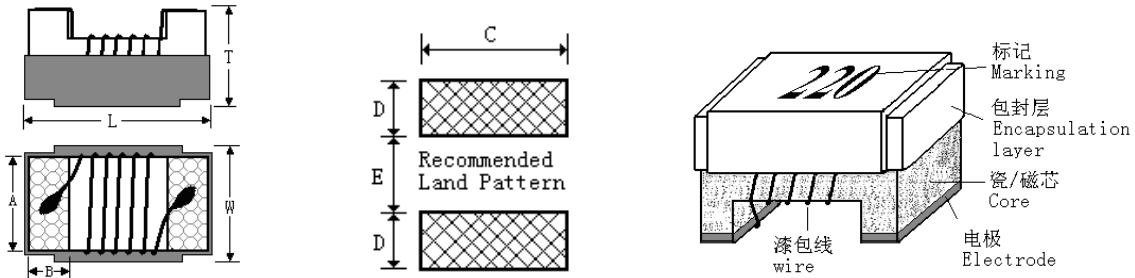

序号 No.	部位 Component	材料 Material												
1	瓷/磁芯 Core	陶瓷芯电感 Ceramic Core: 陶瓷体 $Al_2O_3$ 铁氧体芯电感 Ferrite Core: 镍锌铁氧体 Ni-Zn ferrite												
2	电极 Electrode	<table border="1"> <thead> <tr> <th>分类 Type</th> <th>底层 Layout 0</th> <th>中层 Layout 1</th> <th>表层 Layout 2</th> </tr> </thead> <tbody> <tr> <td>陶瓷芯电感 Ceramic core</td> <td>钨或钼锰 W or Mo-Mn</td> <td>镍 Ni</td> <td>金或锡 Au or Sn</td> </tr> <tr> <td>铁氧体芯电感 Ferrite core</td> <td>银 Ag</td> <td>镍 Ni</td> <td>锡 Sn</td> </tr> </tbody> </table>	分类 Type	底层 Layout 0	中层 Layout 1	表层 Layout 2	陶瓷芯电感 Ceramic core	钨或钼锰 W or Mo-Mn	镍 Ni	金或锡 Au or Sn	铁氧体芯电感 Ferrite core	银 Ag	镍 Ni	锡 Sn
		分类 Type	底层 Layout 0	中层 Layout 1	表层 Layout 2									
		陶瓷芯电感 Ceramic core	钨或钼锰 W or Mo-Mn	镍 Ni	金或锡 Au or Sn									
铁氧体芯电感 Ferrite core	银 Ag	镍 Ni	锡 Sn											
3	漆包线 wire	铜 Cu												
4	包封层 encapsulation layer	树脂 UV Adhesive												
5	标识 Marking	油墨 UV printing ink												

单位 Unit: mm (inch)

型号 Size	L (Max)	W (Max)	T (Max)	A	B	C	D	E
1005(0402)	1.19(0.047)	0.66(0.026)	0.60(0.024)	0.50(0.020)	0.23(0.009)	0.66(0.026)	0.36(0.014)	0.46(0.018)
1608(0603)	1.78(0.070)	1.10(0.043)	0.95(0.037)	0.76(0.030)	0.30(0.012)	1.02(0.040)	0.64(0.025)	0.64(0.025)
2012(0805)	2.30(0.091)	1.70(0.067)	1.52(0.060)	1.27(0.050)	0.50(0.020)	1.78(0.070)	1.02(0.040)	0.76(0.030)
2520(1008)	2.92(0.115)	2.79(0.110)	2.10(0.083)	2.00(0.079)	0.50(0.020)	2.54(0.100)	1.02(0.040)	1.27(0.050)
3225(1210)	3.50(0.138)	2.90(0.114)	2.25(0.088)	2.10(0.083)	0.50(0.020)	2.54(0.100)	1.02(0.040)	1.78(0.070)
4532(1812)	4.80(0.189)	3.40(0.134)	3.15(0.124)	2.53(0.100)	0.65(0.026)	3.05(0.120)	1.14(0.045)	3.00(0.118)

## 3 产品品名构成 Product Spec. Model

FHW 0805 UC R10 J G T

① ② ③ ④ ⑤ ⑥ ⑦

- ① 绕线型片式电感器系列 Wire Wound Inductor Series;
- ② 外形尺寸 Dimensions: 0402、0603、0805、1008、1210、1812;
- ③ 芯片类型 Material: UC、HC---陶瓷芯 Ceramic core; UF、IF、QF---铁氧体芯 Ferrite core;
- ④ 标称电感量 Inductance: 1N0=1.0nH、010=10nH、R10=100nH、1R0=1.0μH、100=10μH、101=100μH、102=1mH;
- ⑤ 标称电感值偏差 Tolerance: F---±1%; G---±2%; J---±5%; K---±10%; M---±20%;
- ⑥ 电极表面镀层材料 Terminal: G---金端头 Gold; S---锡端头 Tin;
- ⑦ 包装类型 Packaging type: T---卷带盘装 Tape&Reel; B---散装 Bulk。



#### 4 电性能参数表 Electrical Characteristics List

型号规格 Part NO.	客户料号 Customer P/N	误差范围 Tolerance (%)	标称感量 Inductance (nH)	感量测试频率 Ls Test frequency (MHz)	Q 值 (Min)	Q 值测试频率 Test frequency (MHz)	直流电阻 Rdc ( $\Omega$ ) max	测试电压 Test voltage (mV)	自谐振频率 SRF (MHz)min	额定电流 Idc (mA)max
FHW0402UC1N0KST		$\pm 10$	1.0	250	13	250	0.045	500	10000	1360
FHW0402UC1N2KST		$\pm 10$	1.2	250	8	250	0.135	500	10000	640
FHW0402UC1N8KST		$\pm 10$	1.8	250	16	250	0.070	500	6000	1040
FHW0402UC1N9KST		$\pm 10$	1.9	250	16	250	0.070	500	6000	1040
FHW0402UC2N0KST		$\pm 10$	2.0	250	18	250	0.070	500	6000	1040
FHW0402UC2N2KST		$\pm 10$	2.2	250	18	250	0.070	500	6000	960
FHW0402UC2N4KST		$\pm 10$	2.4	250	16	250	0.080	500	6000	790
FHW0402UC2N5KST		$\pm 10$	2.5	250	15	250	0.120	500	6000	640
FHW0402UC2N7KST		$\pm 10$	2.7	250	15	250	0.120	500	6000	640
FHW0402UC2N9KST		$\pm 10$	2.9	250	8	250	0.300	500	6000	400
FHW0402UC3N3JST		$\pm 5$	3.3	250	20	250	0.066	500	6000	840
FHW0402UC3N6JST		$\pm 5$	3.6	250	20	250	0.066	500	6000	840
FHW0402UC3N9JST		$\pm 5$	3.9	250	20	250	0.066	500	6000	840
FHW0402UC4N3JST		$\pm 5$	4.3	250	20	250	0.091	500	6000	700
FHW0402UC4N7JST		$\pm 5$	4.7	250	18	250	0.200	500	4500	640
FHW0402UC5N1JST		$\pm 5$	5.1	250	18	250	0.083	500	4800	800
FHW0402UC5N6JST		$\pm 5$	5.6	250	20	250	0.083	500	4800	760
FHW0402UC6N2JST		$\pm 5$	6.2	250	23	250	0.083	500	4800	760
FHW0402UC6N8JST		$\pm 5$	6.8	250	23	250	0.260	500	4800	680
FHW0402UC7N5JST		$\pm 5$	7.5	250	23	250	0.100	500	4800	680
FHW0402UC8N2JST		$\pm 5$	8.2	250	25	250	0.100	500	4400	680
FHW0402UC8N7JST		$\pm 5$	8.7	250	25	250	0.200	500	4100	480
FHW0402UC9N0JST		$\pm 5$	9.0	250	25	250	0.100	500	4160	680
FHW0402UC9N5JST		$\pm 5$	9.5	250	25	250	0.200	500	4000	480
FHW0402UC010JST		$\pm 5$	10	250	25	250	0.20	500	3900	480
FHW0402UC011JST		$\pm 5$	11	250	25	250	0.120	500	3680	640



型号规格 Part NO.	客户料号 Customer P/N	误差范围 Tolerance (%)	标称感量 Inductance (nH)	感量测试频率 Ls Test frequency (MHz)	Q 值 (Min)	Q 值测试频率 Test frequency (MHz)	直流电阻 Rdc ( $\Omega$ ) max	测试电压 Test voltage (mV)	自谐振频率 SRF (MHz)min	额定电流 Idc (mA)max
FHW0402UC012JST		±5	12	250	25	250	0.120	500	3600	640
FHW0402UC013JST		±5	13	250	25	250	0.210	500	3450	440
FHW0402UC015JST		±5	15	250	25	250	0.300	500	3280	560
FHW0402UC016JST		±5	16	250	25	250	0.220	500	3100	560
FHW0402UC018JST		±5	18	250	25	250	0.230	500	3100	420
FHW0402UC019JST		±5	19	250	25	250	0.200	500	3040	480
FHW0402UC020JST		±5	20	250	25	250	0.250	500	3000	420
FHW0402UC022JST		±5	22	250	25	250	0.300	500	2800	400
FHW0402UC023JST		±5	23	250	22	250	0.380	500	2720	310
FHW0402UC024JST		±5	24	250	25	250	0.300	500	2700	400
FHW0402UC027JST		±5	27	250	24	250	0.520	500	2480	280
FHW0402UC030JST		±5	30	250	25	250	0.500	500	2350	400
FHW0402UC033JST		±5	33	250	24	250	0.650	500	2350	350
FHW0402UC036JST		±5	36	250	25	250	0.600	500	2320	250
FHW0402UC039JST		±5	39	250	25	250	0.750	500	2100	200
FHW0402UC040JST		±5	40	250	25	250	0.600	500	2240	220
FHW0402UC043JST		±5	43	250	25	250	0.810	500	2030	100
FHW0402UC047JST		±5	47	250	25	250	0.830	500	2100	150
FHW0402UC051JST		±5	51	250	25	250	0.820	500	1750	100
FHW0402UC056JST		±5	56	250	25	250	0.97	500	1760	100
FHW0402UC062JST		±5	62	250	25	250	1.120	500	1620	100
FHW0402UC068JST		±5	68	250	25	250	1.12	500	1620	100
FHW0402UC075JST		±5	75	250	25	250	1.630	500	1400	50
FHW0402UC082JST		±5	82	250	25	250	1.70	500	1260	50
FHW0402UCR10JST		±5	100	250	25	250	2.00	500	1160	30
FHW0402UCR12JST		±5	120	250	25	250	2.20	500	1100	30

注：FHW0402 系列产品不印标。



型号规格 Part NO.	客户料号 Customer P/N	误差范围 Tolerance (%)	标称感量 Inductance (nH)	感量测试频率 Ls Test frequency (MHz)	Q 值 (Min)	Q 值测试频率 Test frequency (MHz)	直流电阻 Rdc ( $\Omega$ ) max	测试电压 Test voltage (mV)	自谐振频率 SRF (MHz)min	额定电流 Idc (mA)max
FHW0603UC1N6KST		±10	1.6	250	18	250	0.04	500	12500	700
FHW0603UC1N8KST		±10	1.8	250	16	250	0.045	500	12500	700
FHW0603UC2N2KST		±10	2.2	250	12	250	0.09	500	10000	700
FHW0603UC3N3KST		±10	3.3	250	20	250	0.075	500	5900	700
FHW0603UC3N9JST		±5	3.9	250	22	250	0.08	500	6900	700
FHW0603UC4N7JST		±5	4.7	250	20	250	0.116	500	5800	700
FHW0603UC5N6KST		±10	5.6	250	18	250	0.20	500	5700	700
FHW0603UC6N8JST		±5	6.8	250	27	250	0.11	500	5800	700
FHW0603UC7N5JST		±5	7.5	250	28	250	0.11	500	4800	700
FHW0603UC8N2JST		±5	8.2	250	28	250	0.12	500	4700	700
FHW0603UC010JST		±5	10	250	31	250	0.13	500	4800	700
FHW0603UC012JST		±5	12	250	35	250	0.13	500	4000	700
FHW0603UC015JST		±5	15	250	30	250	0.15	500	4000	700
FHW0603UC018JST		±5	18	250	35	250	0.17	500	3100	700
FHW0603UC022JST		±5	22	250	38	250	0.19	500	3000	700
FHW0603UC027JST		±5	27	250	36	250	0.22	500	2800	600
FHW0603UC033JST		±5	33	250	36	250	0.22	500	2300	600
FHW0603UC039JST		±5	39	250	40	250	0.25	500	2200	600
FHW0603UC047JST		±5	47	200	36	200	0.28	500	2000	600
FHW0603UC056JST		±5	56	200	38	200	0.28	500	1900	600
FHW0603UC068JST		±5	68	200	36	200	0.34	500	1700	600
FHW0603UC082JST		±5	82	150	34	150	0.55	500	1700	400
FHW0603UCR10JST		±5	100	150	30	150	0.63	500	1400	400
FHW0603UCR12JST		±5	120	150	32	150	0.73	500	1300	300
FHW0603UCR15JST		±5	150	150	28	150	0.80	500	990	280
FHW0603UCR18JST		±5	180	100	25	100	1.45	500	990	240

注：FHW0603 系列产品不印标。



型号规格 Part NO.	客户料号 Customer P/N	误差范围 Tolerance (%)	标称感量 Inductance (nH)	感量测试频率 Ls Test frequency (MHz)	Q值 (Min)	Q值测试频率 Test frequency (MHz)	直流电阻 Rdc ( $\Omega$ ) max	测试电压 Test voltage (mV)	自谐振频率 SRF (MHz)min	额定电流 Idc (mA)max
FHW0603UCR22JST		±5	220	100	25	100	2.10	500	900	200
FHW0603UCR27JST		±5	270	100	24	100	2.30	500	900	170
FHW0603UCR33JST		±5	330	100	25	100	3.89	500	900	100
FHW0603UCR39JST		±5	390	100	25	100	4.35	500	800	100
FHW0603UCR47JST		±5	470	100	25	100	7.00	500	700	75

注：FHW0603 系列产品不印标。





型号规格 Part NO.	客户料号 Customer P/N	误差范围 Tolerance (%)	标称感量 Inductance (nH)	感量测试频率 Ls Test frequency (MHz)	Q 值 (Min)	Q 值测试频率 Test frequency (MHz)	直流电阻 Rdc ( $\Omega$ ) max	测试电压 Test voltage (mV)	自谐振频率 SRF (MHz)min	额定电流 Idc (mA)max
FHW0805UC2N2KGT		±10	2.2	250	50	1500	0.03	500	8500	800
FHW0805UC2N7JGT		±5	2.7	250	50	1500	0.045	500	8000	800
FHW0805UC3N3KGT		±10	3.3	250	35	1500	0.09	500	7900	600
FHW0805UC4N7KGT		±10	4.7	250	40	1000	0.05	500	6000	600
FHW0805UC5N6JGT		±5	5.6	250	50	1000	0.065	500	5500	600
FHW0805UC6N8JGT		±5	6.8	250	50	1000	0.11	500	5500	600
FHW0805UC8N2JGT		±5	8.2	250	35	1000	0.20	500	4700	600
FHW0805UC010JGT		±5	10	250	50	500	0.15	500	4200	600
FHW0805UC012JGT		±5	12	250	50	500	0.15	500	4000	600
FHW0805UC015JGT		±5	15	250	45	500	0.17	500	3400	600
FHW0805UC018JGT		±5	18	250	55	500	0.20	500	3300	600
FHW0805UC022JGT		±5	22	250	55	500	0.22	500	2600	500
FHW0805UC027JGT		±5	27	250	55	500	0.25	500	2500	500
FHW0805UC033JGT		±5	33	250	55	500	0.27	500	2050	500
FHW0805UC039JGT		±5	39	250	55	500	0.29	500	2000	500
FHW0805UC047JGT		±5	47	200	55	500	0.31	500	1650	500
FHW0805UC056JGT		±5	56	200	55	500	0.34	500	1550	500
FHW0805UC068JGT		±5	68	200	55	500	0.38	500	1450	500
FHW0805UC082JGT		±5	82	150	55	500	0.42	500	1300	400
FHW0805UCR10JGT		±5	100	150	50	500	0.46	500	1200	400
FHW0805UCR12JGT		±5	120	150	45	250	0.51	500	1100	400
FHW0805UCR15JGT		±5	150	100	45	250	0.56	500	920	400
FHW0805UCR18JGT		±5	180	100	45	250	0.64	500	870	400
FHW0805UCR22JGT		±5	220	100	40	250	1.05	500	850	400
FHW0805UCR27JGT		±5	270	100	40	250	1.10	500	650	350
FHW0805UCR33JGT		±5	330	100	40	250	1.40	500	600	310
FHW0805UCR39JGT		±5	390	100	40	250	1.50	500	560	290



型号规格 Part NO.	客户料号 Customer P/N	误差范围 Tolerance (%)	标称感量 Inductance (nH)	感量测试频率 Ls Test frequency (MHz)	Q 值 (Min)	Q 值测试频率 Test frequency (MHz)	直流电阻 Rdc ( $\Omega$ ) max	测试电压 Test voltage (mV)	自谐振频率 SRF (MHz)min	额定电流 Idc (mA)max
FHW0805UCR47JGT		±5	470	50	33	100	2.00	500	375	250
FHW0805UCR56JGT		±5	560	25	23	50	1.90	500	340	230
FHW0805UCR68JGT		±5	680	25	23	50	2.10	500	300	190
FHW0805UCR82JGT		±5	820	25	23	50	2.14	500	250	180
FHW0805UC1R0JGT		±5	1000	25	20	50	2.40	500	200	170
FHW0805UC1R2JGT		±5	1200	7.9	18	50	2.55	500	180	170
FHW0805UC1R5JGT		±5	1500	7.9	18	50	2.80	500	170	160
FHW0805UC1R8JGT		±5	1800	7.9	18	50	3.80	500	140	150
FHW0805UC2R2JGT		±5	2200	7.9	16	7.9	4.20	500	50	150



型号规格 Part NO.	客户料号 Customer P/N	误差范围 Tolerance (%)	标称感量 Inductance (nH)	感量测试频率 Ls Test frequency (MHz)	Q 值 (Min)	Q 值测试频率 Test frequency (MHz)	直流电阻 Rdc ( $\Omega$ ) max	测试电压 Test voltage (mV)	自谐振频率 SRF (MHz)min	额定电流 Idc (mA)max
FHW1008UC3N9JGT		±5	3.9	50	50	1500	0.035	500	6000	1000
FHW1008UC4N7JGT		±5	4.7	50	50	1500	0.045	500	6000	1000
FHW1008UC5N6JGT		±5	5.6	50	30	1000	0.18	500	6000	1000
FHW1008UC010JGT		±5	10	50	50	500	0.08	500	4100	1000
FHW1008UC012JGT		±5	12	50	50	500	0.09	500	3300	1000
FHW1008UC015JGT		±5	15	50	45	500	0.15	500	2500	1000
FHW1008UC018JGT		±5	18	50	50	350	0.11	500	2500	1000
FHW1008UC022JGT		±5	22	50	55	350	0.12	500	2400	1000
FHW1008UC027JGT		±5	27	50	55	350	0.13	500	1600	1000
FHW1008UC033JGT		±5	33	50	60	350	0.14	500	1600	1000
FHW1008UC039JGT		±5	39	50	60	350	0.15	500	1500	1000
FHW1008UC047JGT		±5	47	50	65	350	0.16	500	1500	1000
FHW1008UC056JGT		±5	56	50	65	350	0.18	500	1100	1000
FHW1008UC068JGT		±5	68	50	65	350	0.20	500	1000	1000
FHW1008UC082JGT		±5	82	50	60	350	0.22	500	1000	1000
FHW1008UCR10JGT		±5	100	25	60	350	0.56	500	1000	650
FHW1008UCR12JGT		±5	120	25	60	350	0.63	500	950	650
FHW1008UCR15JGT		±5	150	25	45	100	0.70	500	800	580
FHW1008UCR18JGT		±5	180	25	45	100	0.77	500	640	620
FHW1008UCR22JGT		±5	220	25	45	100	0.84	500	620	500
FHW1008UCR27JGT		±5	270	25	45	100	0.91	500	600	500
FHW1008UCR33JGT		±5	330	25	45	100	1.05	500	500	450
FHW1008UCR39JGT		±5	390	25	45	100	1.12	500	480	470
FHW1008UCR47JGT		±5	470	25	45	100	1.19	500	450	470
FHW1008UCR56JGT		±5	560	25	45	100	1.33	500	415	400
FHW1008UCR68JGT		±5	680	25	45	100	1.47	500	375	400
FHW1008UCR82JGT		±5	820	25	45	100	1.61	500	250	400
FHW1008UC1R0JGT		±5	1000	25	35	50	1.75	500	210	370



型号规格 Part NO.	客户料号 Customer P/N	误差范围 Tolerance (%)	标称感量 Inductance (nH)	感量测试频率 Ls Test frequency (MHz)	Q 值 (Min)	Q 值测试频率 Test frequency (MHz)	直流电阻 Rdc ( $\Omega$ ) max	测试电压 Test voltage (mV)	自谐振频率 SRF (MHz)min	额定电流 Idc (mA)max
FHW1008UC1R2JGT		±5	1200	7.9	35	50	2.00	500	200	310
FHW1008UC1R5JGT		±5	1500	7.9	28	50	2.30	500	180	330
FHW1008UC1R8JGT		±5	1800	7.9	28	50	2.60	500	160	300
FHW1008UC2R2JGT		±5	2200	7.9	20	50	2.80	500	90	280
FHW1008UC2R7JGT		±5	2700	7.9	22	25	3.20	500	80	290
FHW1008UC3R3JGT		±5	3300	7.9	22	25	3.40	500	70	290
FHW1008UC3R9JGT		±5	3900	7.9	16	25	3.60	500	60	260
FHW1008UC4R7JGT		±5	4700	7.9	18	25	4.00	500	60	260
FHW1008UC5R6JGT		±5	5600	7.9	18	7.9	7.60	500	55	240
FHW1008UC6R8JGT		±5	6800	7.9	18	7.9	8.20	500	50	200
FHW1008UC8R2JGT		±5	8200	7.9	18	7.9	8.20	500	40	170
FHW1008UC100JGT		±5	10000	7.9	20	7.9	9.10	500	40	160



型号规格 Part NO.	客户料号 Customer P/N	误差范围 Tolerance (%)	标称感量 Inductance (nH)	感量测试频率 Ls Test frequency (MHz)	Q 值 (Min)	Q 值测试频率 Test frequency (MHz)	直流电阻 Rdc ( $\Omega$ ) max	测试电压 Test voltage (mV)	自谐振频率 SRF (MHz)min	额定电流 Idc (mA)max
FHW1210HC3N9KGT		±10	3.9	100	30	300	0.05	500	6000	1000
FHW1210HC4N7JGT		±5	4.7	100	30	300	0.065	500	5800	1000
FHW1210HC8N2KGT		±10	8.2	100	30	300	0.07	500	5500	1000
FHW1210HC010JGT		±5	10	100	40	300	0.08	500	4000	1000
FHW1210HC012JGT		±5	12	100	40	300	0.08	500	3200	1000
FHW1210HC015JGT		±5	15	100	40	300	0.10	500	3200	1000
FHW1210HC018JGT		±5	18	100	50	300	0.10	500	2800	1000
FHW1210HC022JGT		±5	22	100	50	300	0.10	500	2000	1000
FHW1210HC027JGT		±5	27	100	50	300	0.11	500	1800	1000
FHW1210HC033JGT		±5	33	100	55	300	0.11	500	1800	1000
FHW1210HC039JGT		±5	39	100	55	300	0.12	500	1800	1000
FHW1210HC047JGT		±5	47	100	55	300	0.13	500	1500	1000
FHW1210HC056JGT		±5	56	100	55	300	0.14	500	1450	1000
FHW1210HC068JGT		±5	68	100	55	300	0.15	500	1200	900
FHW1210HC082JGT		±5	82	100	55	300	0.20	500	1000	900
FHW1210HCR10JGT		±5	100	100	55	300	0.21	500	900	850
FHW1210HCR12JGT		±5	120	100	60	300	0.21	500	800	800
FHW1210HCR15JGT		±5	150	100	60	300	0.25	500	780	750
FHW1210HCR18JGT		±5	180	50	60	300	0.30	500	760	700
FHW1210HCR22JGT		±5	220	50	60	300	0.32	500	650	670
FHW1210HCR27JGT		±5	270	50	55	300	0.34	500	620	630
FHW1210HCR33JGT		±5	330	50	45	150	0.38	500	600	590
FHW1210HCR39JGT		±5	390	50	45	150	0.58	500	510	530
FHW1210HCR47JGT		±5	470	50	45	150	0.80	500	500	490
FHW1210HCR56JGT		±5	560	35	45	150	1.10	500	420	460
FHW1210HCR68JGT		±5	680	35	45	150	1.20	500	400	430
FHW1210HCR82JGT		±5	820	35	45	150	1.82	500	370	400



型号规格 Part NO.	客户料号 Customer P/N	误差范围 Tolerance (%)	标称感量 Inductance (nH)	感量测试频率 Ls Test frequency (MHz)	Q值 (Min)	Q值测试频率 Test frequency (MHz)	直流电阻 Rdc ( $\Omega$ ) max	测试电压 Test voltage (mV)	自谐振频率 SRF (MHz) <sub>min</sub>	额定电流 Idc (mA) <sub>max</sub>
FHW1210HC1R0JGT		±5	1000	35	45	150	1.85	500	340	320
FHW1210HC1R2JGT		±5	1200	35	35	150	1.87	500	220	300
FHW1210HC1R5JGT		±5	1500	7.9	30	50	1.95	500	160	310
FHW1210HC1R8JGT		±5	1800	7.9	30	50	2.25	500	160	310
FHW1210HC2R2JGT		±5	2200	7.9	30	50	2.41	500	110	310
FHW1210HC2R7JGT		±5	2700	7.9	25	25	2.85	500	100	300
FHW1210HC3R3JGT		±5	3300	7.9	20	25	3.12	500	85	300
FHW1210HC3R9JGT		±5	3900	7.9	20	25	3.60	500	80	290
FHW1210HC4R7JGT		±5	4700	7.9	16	25	4.00	500	60	280
FHW1210HC5R6JGT		±5	5600	7.9	20	7.9	5.00	500	60	250
FHW1210HC6R8JGT		±5	6800	7.9	20	7.9	8.00	500	55	230
FHW1210HC8R2JGT		±5	8200	7.9	20	7.9	8.60	500	50	170
FHW1210HC100JGT		±5	10000	7.9	22	7.9	6.80	500	20	200



型号规格 Part NO.	客户料号 Customer P/N	误差范围 Tolerance (%)	标称感量 Inductance ( $\mu$ H)	感量测试频率 Ls Test frequency (MHz)	Q 值 (Min)	Q 值测试频率 Test frequency (MHz)	直流电阻 Rdc ( $\Omega$ ) max	测试电压 Test voltage (mV)	自谐振频率 SRF (MHz)min	额定电流 Idc (mA)max
FHW0603UFR10JST		±5	0.10	7.9	12	7.9	0.13	500	1150	1000
FHW0603UFR12JST		±5	0.12	7.9	12	7.9	0.16	500	1100	1000
FHW0603UFR15JST		±5	0.15	7.9	12	7.9	0.15	500	1050	1000
FHW0603UFR18JST		±5	0.18	7.9	12	7.9	0.15	500	950	1000
FHW0603UFR22JST		±5	0.22	7.9	12	7.9	0.20	500	900	900
FHW0603UFR27JST		±5	0.27	7.9	12	7.9	0.30	500	775	700
FHW0603UFR33JST		±5	0.33	7.9	12	7.9	0.32	500	725	600
FHW0603UFR39JST		±5	0.39	7.9	12	7.9	0.51	500	620	500
FHW0603UFR47JST		±5	0.47	7.9	12	7.9	0.62	500	540	420
FHW0603UFR56JST		±5	0.56	7.9	12	7.9	0.65	500	600	400
FHW0603UFR68JST		±5	0.68	7.9	12	7.9	1.00	500	500	380
FHW0603UFR82JST		±5	0.82	7.9	12	7.9	1.30	500	500	350
FHW0603UF1R0JST		±5	1.0	7.9	12	7.9	1.50	500	400	330
FHW0603UF1R2JST		±5	1.2	7.9	12	7.9	1.70	500	380	320
FHW0603UF1R5JST		±5	1.5	7.9	12	7.9	1.90	500	300	310
FHW0603UF1R8JST		±5	1.8	7.9	12	7.9	2.20	500	180	300
FHW0603UF2R2JST		±5	2.2	7.9	12	7.9	2.30	500	180	280
FHW0603UF2R7JST		±5	2.7	7.9	12	7.9	3.10	500	150	250
FHW0603UF3R3JST		±5	3.3	7.9	12	7.9	2.90	500	150	230
FHW0603UF3R9JST		±5	3.9	7.9	12	7.9	3.20	500	120	210
FHW0603UF4R7JST		±5	4.7	7.9	12	7.9	4.00	500	100	200

注：FHW0603 系列产品不印标。



型号规格 Part NO.	客户料号 Customer P/N	误差范围 Tolerance (%)	标称感量 Inductance (μH)	感量测试频率 Ls Test frequency (MHz)	Q值 (Min)	Q值测试频率 Test frequency (MHz)	直流电阻 Rdc (Ω) max	测试电压 Test voltage (mV)	自谐振频率 SRF (MHz)min	额定电流 Idc (mA)max
FHW0805UFR47JST		±5	0.47	25.2	10	25.2	0.40	500	450	500
FHW0805UFR56JST		±5	0.56	25.2	10	25.2	0.40	500	450	500
FHW0805UFR68JST		±5	0.68	25.2	10	25.2	0.60	500	400	500
FHW0805UFR82JST		±5	0.82	25.2	10	25.2	0.80	500	400	500
FHW0805UF1R0JST		±5	1.0	7.96	10	7.96	1.00	500	360	430
FHW0805UF1R2JST		±5	1.2	7.96	10	7.96	1.15	500	350	410
FHW0805UF1R5JST		±5	1.5	7.96	10	7.96	1.20	500	300	400
FHW0805UF1R8JST		±5	1.8	7.96	10	7.96	1.35	500	200	380
FHW0805UF2R2JST		±5	2.2	7.96	10	7.96	1.50	500	170	350
FHW0805UF2R7JST		±5	2.7	7.96	10	7.96	1.70	500	100	320
FHW0805UF3R3JST		±5	3.3	7.96	10	7.96	1.80	500	90	300
FHW0805UF3R9JST		±5	3.9	7.96	10	7.96	1.95	500	90	280
FHW0805UF4R7JST		±5	4.7	7.96	10	7.96	2.05	500	85	250
FHW0805UF5R6JST		±5	5.6	7.96	10	7.96	2.30	500	70	240
FHW0805UF6R8JST		±5	6.8	7.96	10	7.96	2.60	500	55	220
FHW0805UF8R2JST		±5	8.2	7.96	10	7.96	3.00	500	50	180
FHW0805UF100JST		±5	10	2.52	8	2.52	3.20	500	30	150
FHW0805UF120JST		±5	12	2.52	8	2.52	3.50	500	17	110
FHW0805UF150JST		±5	15	2.52	8	2.52	4.20	500	16	100
FHW0805UF180JST		±5	18	2.52	8	2.52	4.50	500	15	95
FHW0805UF220JST		±5	22	2.52	8	2.52	6.00	500	14	80





型号规格 Part NO.	客户料号 Customer P/N	误差范围 Tolerance (%)	标称感量 Inductance ( $\mu$ H)	感量测试频率 Ls Test frequency (MHz)	Q 值 (Min)	Q 值测试频率 Test frequency (MHz)	直流电阻 Rdc ( $\Omega$ ) max	测试电压 Test voltage (mV)	自谐振频率 SRF (MHz)min	额定电流 Idc (mA)max
FHW1008IFR12JST		±5	0.12	25.2	12	25.2	0.15	500	850	800
FHW1008IFR39JST		±5	0.39	25.2	12	25.2	0.29	500	480	600
FHW1008IFR56JST		±5	0.56	25.2	12	25.2	0.42	500	330	600
FHW1008IFR68JST		±5	0.68	25.2	12	25.2	0.45	500	330	600
FHW1008IFR82JST		±5	0.82	25.2	12	25.2	0.62	500	300	600
FHW1008IF1R0JST		±5	1.0	25.2	12	25.2	0.55	500	300	580
FHW1008IF1R2JST		±5	1.2	7.96	12	7.96	0.75	500	250	550
FHW1008IF1R5JST		±5	1.5	7.96	12	7.96	0.85	500	230	400
FHW1008IF1R8JST		±5	1.8	7.96	12	7.96	0.95	500	168	320
FHW1008IF2R2JST		±5	2.2	7.96	12	7.96	1.30	500	150	315
FHW1008IF2R7JST		±5	2.7	7.96	12	7.96	1.40	500	100	300
FHW1008IF3R3JST		±5	3.3	7.96	12	7.96	1.50	500	80	280
FHW1008IF3R9JST		±5	3.9	7.96	12	7.96	1.55	500	60	250
FHW1008IF4R7JST		±5	4.7	7.96	12	7.96	1.75	500	50	210
FHW1008IF5R6JST		±5	5.6	7.96	12	7.96	1.90	500	40	190
FHW1008IF6R8JST		±5	6.8	7.96	12	7.96	2.00	500	35	175
FHW1008IF8R2JST		±5	8.2	7.96	12	7.96	2.20	500	25	160
FHW1008IF100JST		±5	10	2.52	10	2.52	2.50	500	25	155
FHW1008IF120JST		±5	12	2.52	10	2.52	2.60	500	20	145
FHW1008IF150JST		±5	15	2.52	10	2.52	3.00	500	20	130
FHW1008IF180JST		±5	18	2.52	10	2.52	3.00	500	20	130
FHW1008IF220JST		±5	22	2.52	10	2.52	3.90	500	18	105
FHW1008IF270JST		±5	27	2.52	10	2.52	4.00	500	10	100
FHW1008IF330JST		±5	33	2.52	10	2.52	4.80	500	8	85
FHW1008IF390JST		±5	39	2.52	10	2.52	5.00	500	7	80
FHW1008IF470JST		±5	47	2.52	10	2.52	5.70	500	7	60
FHW1008IF560JST		±5	56	2.52	10	2.52	6.00	500	6.5	55
FHW1008IF680JST		±5	68	2.52	10	2.52	6.70	500	6.5	50



型号规格 Part NO.	客户料号 Customer P/N	误差范围 Tolerance (%)	标称感量 Inductance (μH)	感量测试频率 Ls Test frequency (MHz)	Q 值 (Min)	Q 值测试频率 Test frequency (MHz)	直流电阻 Rdc (Ω) max	测试电压 Test voltage (mV)	自谐振频率 SRF (MHz)min	额定电流 Idc (mA)max
FHW1008IF820JST		±5	82	2.52	10	2.52	7.50	500	6.5	45
FHW1008IF101JST		±5	100	0.796	8	0.796	11.0	500	4.5	40
FHW1008IF121JST		±5	120	0.796	8	0.796	13.0	500	3	30
FHW1008IF151JST		±5	150	0.796	8	0.796	15.0	500	3	25
FHW1008IF221KST		±10	220	0.796	8	0.796	18.0	500	2.5	20



型号规格 Part NO.	客户料号 Customer P/N	误差范围 Tolerance (%)	标称感量 Inductance ( $\mu$ H)	感量测试频率 Ls Test frequency (MHz)	Q 值 (Min)	Q 值测试频率 Test frequency (MHz)	直流电阻 Rdc ( $\Omega$ ) max	测试电压 Test voltage (mV)	自谐振频率 SRF (MHz)min	额定电流 Idc (mA)max
FHW1210IF1R0JST		$\pm 5$	1.0	7.96	12	7.96	0.30	500	220	450
FHW1210IF1R2JST		$\pm 5$	1.2	7.96	12	7.96	0.30	500	210	450
FHW1210IF1R5JST		$\pm 5$	1.5	7.96	12	7.96	0.40	500	200	450
FHW1210IF1R8JST		$\pm 5$	1.8	7.96	12	7.96	0.50	500	195	450
FHW1210IF2R2JST		$\pm 5$	2.2	7.96	12	7.96	0.60	500	175	450
FHW1210IF2R7JST		$\pm 5$	2.7	7.96	12	7.96	0.70	500	120	420
FHW1210IF3R3JST		$\pm 5$	3.3	7.96	12	7.96	1.10	500	80	380
FHW1210IF3R9JST		$\pm 5$	3.9	7.96	12	7.96	1.20	500	75	360
FHW1210IF4R7JST		$\pm 5$	4.7	7.96	12	7.96	1.30	500	60	350
FHW1210IF5R6JST		$\pm 5$	5.6	7.96	12	7.96	2.00	500	50	320
FHW1210IF6R8JST		$\pm 5$	6.8	7.96	12	7.96	1.50	500	35	310
FHW1210IF8R2JST		$\pm 5$	8.2	7.96	12	7.96	1.60	500	35	305
FHW1210IF100JST		$\pm 5$	10	2.52	10	2.52	1.00	500	30	300
FHW1210IF120JST		$\pm 5$	12	2.52	10	2.52	1.20	500	25	265
FHW1210IF150JST		$\pm 5$	15	2.52	10	2.52	2.00	500	22	225
FHW1210IF180JST		$\pm 5$	18	2.52	10	2.52	2.10	500	22	210
FHW1210IF220JST		$\pm 5$	22	2.52	10	2.52	2.40	500	20	200
FHW1210IF270JST		$\pm 5$	27	2.52	10	2.52	2.70	500	18	180
FHW1210IF330JST		$\pm 5$	33	2.52	10	2.52	2.90	500	15	160
FHW1210IF390JST		$\pm 5$	39	2.52	10	2.52	4.70	500	16	150
FHW1210IF470JST		$\pm 5$	47	2.52	10	2.52	5.20	500	10	140
FHW1210IF560JST		$\pm 5$	56	2.52	10	2.52	5.60	500	8.0	125
FHW1210IF680JST		$\pm 5$	68	2.52	10	2.52	4.70	500	5.0	110
FHW1210IF820JST		$\pm 5$	82	2.52	10	2.52	5.60	500	5.0	100
FHW1210IF101JST		$\pm 5$	100	0.796	8	0.796	6.80	500	5.0	95
FHW1210IF121JST		$\pm 5$	120	0.796	8	0.796	7.90	500	4.0	85
FHW1210IF151JST		$\pm 5$	150	0.796	8	0.796	9.00	500	4.0	80



型号规格 Part NO.	客户料号 Customer P/N	误差范围 Tolerance (%)	标称感量 Inductance ( $\mu$ H)	感量测试频率 Ls Test frequency (MHz)	Q 值 (Min)	Q 值测试频率 Test frequency (MHz)	直流电阻 Rdc ( $\Omega$ ) max	测试电压 Test voltage (mV)	自谐振频率 SRF (MHz)min	额定电流 Idc (mA)max
FHW1210IF181JST		$\pm 5$	180	0.796	8	0.796	14.5	500	3.0	70
FHW1210IF221JST		$\pm 5$	220	0.796	8	0.796	16.5	500	2.6	65
FHW1210IF271KST		$\pm 10$	270	0.796	8	0.796	18.0	500	2.5	60
FHW1210IF331KST		$\pm 10$	330	0.796	8	0.796	19.0	500	2.3	55
FHW1210IF391KST		$\pm 10$	390	0.796	8	0.796	21.5	500	2.2	45
FHW1210IF471KST		$\pm 10$	470	0.796	8	0.796	22.5	500	2.0	40



型号规格 Part NO.	客户料号 Customer P/N	误差范围 Tolerance (%)	标称感量 Inductance ( $\mu$ H)	感量测试频率 Ls Test frequency (MHz)	Q 值 (Min)	Q 值测试频率 Test frequency (MHz)	直流电阻 Rdc ( $\Omega$ ) max	测试电压 Test voltage (mV)	自谐振频率 SRF (MHz)min	额定电流 Idc (mA)max
FHW1812IFR33JST		$\pm 5$	0.33	25.2	10	25.2	0.13	500	380	1000
FHW1812IFR56JST		$\pm 5$	0.56	25.2	10	25.2	0.15	500	300	1000
FHW1812IF1R0JST		$\pm 5$	1.0	7.96	15	7.96	0.22	500	200	1000
FHW1812IF1R2JST		$\pm 5$	1.2	7.96	15	7.96	0.35	500	200	1000
FHW1812IF1R5JST		$\pm 5$	1.5	7.96	15	7.96	0.32	500	180	1000
FHW1812IF1R8JST		$\pm 5$	1.8	7.96	15	7.96	0.35	500	160	950
FHW1812IF2R2JST		$\pm 5$	2.2	7.96	15	7.96	0.37	500	150	900
FHW1812IF2R7JST		$\pm 5$	2.7	7.96	15	7.96	0.37	500	145	850
FHW1812IF3R3JST		$\pm 5$	3.3	7.96	15	7.96	0.48	500	140	800
FHW1812IF3R9JST		$\pm 5$	3.9	7.96	15	7.96	0.60	500	135	750
FHW1812IF4R7JST		$\pm 5$	4.7	7.96	15	7.96	1.00	500	120	700
FHW1812IF5R6JST		$\pm 5$	5.6	7.96	15	7.96	0.55	500	110	650
FHW1812IF6R8JST		$\pm 5$	6.8	7.96	15	7.96	0.80	500	80	600
FHW1812IF8R2JST		$\pm 5$	8.2	7.96	10	7.96	0.85	500	70	600
FHW1812IF100JST		$\pm 5$	10	2.52	10	2.52	1.00	500	65	550
FHW1812IF120JST		$\pm 5$	12	2.52	10	2.52	1.10	500	55	550
FHW1812IF150JST		$\pm 5$	15	2.52	10	2.52	1.20	500	35	500
FHW1812IF180JST		$\pm 5$	18	2.52	10	2.52	1.20	500	29	500
FHW1812IF220JST		$\pm 5$	22	2.52	10	2.52	1.30	500	20	450
FHW1812IF270JST		$\pm 5$	27	2.52	10	2.52	1.50	500	20	400
FHW1812IF330JST		$\pm 5$	33	2.52	10	2.52	1.70	500	18	350
FHW1812IF390JST		$\pm 5$	39	2.52	10	2.52	1.80	500	14	350
FHW1812IF470JST		$\pm 5$	47	2.52	10	2.52	2.00	500	10	300
FHW1812IF560JST		$\pm 5$	56	2.52	10	2.52	2.20	500	10	290
FHW1812IF680JST		$\pm 5$	68	2.52	10	2.52	2.40	500	5.4	260
FHW1812IF820JST		$\pm 5$	82	2.52	10	2.52	2.80	500	5.2	240
FHW1812IF101JST		$\pm 5$	100	0.796	10	0.796	3.00	500	4.0	220



型号规格 Part NO.	客户料号 Customer P/N	误差范围 Tolerance (%)	标称感量 Inductance ( $\mu$ H)	感量测试频率 Ls Test frequency (MHz)	Q 值 (Min)	Q 值测试频率 Test frequency (MHz)	直流电阻 Rdc ( $\Omega$ ) max	测试电压 Test voltage (mV)	自谐振频率 SRF (MHz)min	额定电流 Idc (mA)max
FHW1812IF121JST		$\pm 5$	120	0.796	10	0.796	3.30	500	3.3	220
FHW1812IF151JST		$\pm 5$	150	0.796	10	0.796	3.70	500	3.0	200
FHW1812IF181JST		$\pm 5$	180	0.796	10	0.796	4.50	500	3.0	200
FHW1812IF221JST		$\pm 5$	220	0.796	10	0.796	8.00	500	2.5	170
FHW1812IF271JST		$\pm 5$	270	0.796	10	0.796	8.50	500	2.2	160
FHW1812IF331KST		$\pm 10$	330	0.796	10	0.796	9.00	500	2.0	150
FHW1812IF391KST		$\pm 10$	390	0.796	10	0.796	9.50	500	1.8	130
FHW1812IF471KST		$\pm 10$	470	0.796	8	0.796	10.4	500	1.6	120
FHW1812IF561KST		$\pm 10$	560	0.796	8	0.796	12.5	500	1.5	110
FHW1812IF681KST		$\pm 10$	680	0.796	8	0.796	14.0	500	1.5	100
FHW1812IF821KST		$\pm 10$	820	0.796	8	0.796	15.0	500	1.5	95
FHW1812IF102KST		$\pm 10$	1000	0.252	6	0.252	16.5	500	1.4	90

注：FHW1812IF 除 1R0、2R2、3R3、3R9、4R7、5R6、100、150、220、270、330、390、560、820、101、271、471、561、681、821、102 外，其余产品不印标。



## 5 可靠性试验项目 Reliability Testing Items

序号 No.	项目 Items	要求 Requirements	试验方法及备注 Test Methods and Remarks
1	试验用标准条件 Test Standard Conditions	<p>①、除非另有规定，所有试验和测量在下述条件进行。Unless otherwise specified, all tests and measurements shall be carried out in the following conditions.</p> <p>a) 温度 Temperature: 15℃~+35℃;</p> <p>b) 相对湿度 Relative humidity: 25%~75%;</p> <p>c) 气压 pressure: 86 kPa~106 kPa.</p> <p>②、在上述条件下测定有异议发生场合，按下述条件进行。Under the above conditions, the conditions for the determination of dissension shall be conducted according to the following conditions.</p> <p>a) 温度 Temperature: 20℃±1℃;</p> <p>b) 相对湿度 Relative humidity: 63%~67%;</p> <p>c) 气压 pressure: 86 kPa~106 kPa.</p>	
2	工作温度范围 Operating Temperature Range	<p>① FHW-UC/HC series: -40℃~+125℃</p> <p>② FHW-UF/IF/QF/HF series: -40~+85℃</p>	/
3	可焊性 Solder ability	<p>① 外观无可见损伤痕迹; No visible mechanical damage.</p> <p>② 端电极表面焊锡覆盖率。 Electrode surface solder coverage. FHW-UC/HC series: ≥90%; FHW-UF/IF/QF series: ≥80%.</p>	<p>在 245±5℃ 熔融的焊锡 (96.5%Sn/3.0%Ag/0.5%Cu) 中浸置 5±1s。 Dip pads in flux and dip in solder pot(96.5Sn/3.0Ag/0.5Cu)at 245±5℃ for 5±1s.</p>
4	耐焊接热 Resistance to Soldering	<p>① 外观无可见损伤痕迹; No visible mechanical damage.</p> <p>② 感量变化不超过±5%; Inductance shall not change more than ±5%;</p> <p>③ Q 值变化不超过±10%。 Q shall not change more than±10%.</p>	<p>在 260±5℃ 熔融的焊锡 (96.5%Sn/3.0%Ag/0.5%Cu) 中浸置 10±1s。 Dip pads in flux and dip in solder pot(96.5Sn/3.0Ag/0.5Cu)at 260±5℃ for 10±1s.</p>
5	绝缘电阻 Insulation Resistance	<p>① FHW-UF/IF/QF series: ≥500MΩ;</p> <p>② FHW-UC/HC series: ≥1000 MΩ。</p>	<p>在电感器端子和包封层间施加 100V±15V 直流电压，持续 1 分钟。Input 100V±15V DC between the electrodes and the resin of inductor and keep on 1 minute.</p>

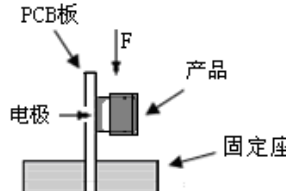

序号 No.	项目 Items	要求 Requirements	试验方法及备注 Test Methods and Remarks														
6	振动 Vibration	①外观无可见损伤痕迹; No visible mechanical damage. ②感量变化不超过±5%; Inductance shall not change more than ±5%; ③Q 值变化不超过±10%。 Q shall not change more than±10%.	振幅 1.5mm, 频率 10~55Hz, 每个方向 (X、Y、Z) 保持 2 小时。Inductors shall be subjected to vibration of 1.5mm amplitude frequency 10~55Hz (10Hz to 55Hz to 10Hz in a period of 1 minute) for 2h in each of three(X、Y、Z) axes.														
7	端电极强度 Adhesion of electrode	①试验后端电极无脱落; The end electrode did not fall off after the test. ②外观无可见损伤痕迹。 No visible mechanical damage.	将产品焊在 PCB 板上, 按下图、表所示方向及要求施加作用力。Weld the product on the PCB board, and apply force as shown in the diagram, direction and requirement.  <table border="1" data-bbox="997 1120 1452 1512"> <thead> <tr> <th>尺寸规格 Size</th> <th>施加力要求</th> </tr> </thead> <tbody> <tr> <td>0402UC Series</td> <td>4.5 N</td> </tr> <tr> <td>0603UF Series</td> <td>7 N</td> </tr> <tr> <td>0603UC、0805UF Series</td> <td>13 N</td> </tr> <tr> <td>0805UC And Above Series.</td> <td>20 N</td> </tr> <tr> <td colspan="2">Keep time: (10±1)s</td> </tr> <tr> <td colspan="2">Speed: 1.0 mm/s.</td> </tr> </tbody> </table>	尺寸规格 Size	施加力要求	0402UC Series	4.5 N	0603UF Series	7 N	0603UC、0805UF Series	13 N	0805UC And Above Series.	20 N	Keep time: (10±1)s		Speed: 1.0 mm/s.	
尺寸规格 Size	施加力要求																
0402UC Series	4.5 N																
0603UF Series	7 N																
0603UC、0805UF Series	13 N																
0805UC And Above Series.	20 N																
Keep time: (10±1)s																	
Speed: 1.0 mm/s.																	
8	耐低温 Low temperature resistance	①外观无可见损伤痕迹; No visible mechanical damage. ②感量变化不超过±5%; Inductance shall not change more than ±5%; ③Q 值变化不超过±10%。 Q shall not change more than±10%.	①FHW-UC/HC 系列产品放置于温度-55±2℃ +24 的环境中存放 1000-0 h FHW-UC/HC series shall be subjected +24 to-55±2℃ for 1000-0 h ②FHW-UF/IF/QF 系列产品放置于温度-40± +24 2℃的环境中存放 1000-0 h FHW-UF/IF/QF series shall be subjected +24 to -40±2℃ for1000-0 h														





序号 No.	项目 Items	要求 Requirements	试验方法及备注 Test Methods and Remarks
9	耐高温 High temperature resistance	①外观无可见损伤痕迹; No visible mechanical damage. ②感量变化不超过±5%; Inductance shall not change more than ±5%; ③Q 值变化不超过±10%。 Q shall not change more than±10%.	①FHW-UC/HC 系列产品放置于温度+125±5℃ +24 的环境中存放 1000—0 h FHW-UC/HC series shall be subjected to +24 +125±5℃ for1000—0 h ②FHW-UF/IF/QF 系列产品放置于温度+85±5℃ +24 的环境中存放 1000—0 h FHW-UF/IF/QF series shall be subjected to +24 +85±5℃ for 1000—0 h
10	温度特性 Temperature Characteristic	电感量随温度变化率不超过±5%。 Inductance shall not change more than ±5%.	①在以下每个温度保持 4 小时。 In the following each temperature keep the 4 h. a)20±2℃; b)FHW-UC/HC Series: -55±2℃, FHW-UF/IF/QF Series: -40±2℃; c)20±2℃; d)FHW-UC/HC Series: 125±2℃, FHW-UF/IF/QF Series: 85±2℃。 ②然后以 c)温度为基础上分别与最高温及最低温下电感偏差值计算变化率。 Then based on the temperature of C, the variation rate of the inductance deviation at the highest temperature and the lowest temperature is calculated respectively.
11	温度循环 Thermal Shock	①外观无可见损伤痕迹; No visible mechanical damage. ②感量变化不超过±5%; Inductance shall not change more than ±5%; ③Q 值变化不超过±10%。 Q shall not change more than±10%.	①FHW-UC/HC 系列: +125℃ 60 分钟 ↔ -55℃ 60 分, 钟循环 100 次; FHW-UC/HC series : +125℃ 60minutes ↔ -55℃ 60minutes 100 Cycles. ②FHW-UF/IF/QF 系列: +85℃ 60 分钟 ↔ -40℃ 60 分, 钟循环 32 次; FHW-UF/IF/QF series: +85℃ 60minutes ↔ -40℃ 60minutes 32 Cycles.

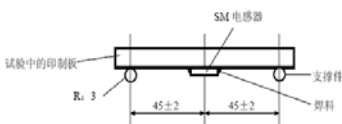
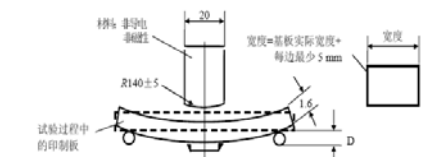

序号 No.	项目 Items	要求 Requirements	试验方法及备注 Test Methods and Remarks
12	高温负载 High temperature load	①外观无可见损伤痕迹; No visible mechanical damage. ②感量变化不超过±5%; Inductance shall not change more than ±5%; ③Q 值变化不超过±10%. Q shall not change more than±10%.	①FHW-UC/HC 系列产品加额定电流在 $125 \pm 2^\circ\text{C}$ $+24$ 温度条件下存放 $1000 - 0$ h FHW-UC/HC series shall be store at $125 \pm 2^\circ\text{C}$ $+24$ for $1000 - 0$ h with rated current applied. ②FHW-UF/IF/QF 系列产品加额定电流在 $85 \pm$ $+24$ $2^\circ\text{C}$ 温度条件下存放 $1000 - 0$ h FHW-UF/IF/QF/HF series shall be store at $+24$ $85 \pm 2^\circ\text{C}$ for $1000 - 0$ h with rated current applied.
13	恒定湿热 Static Humidity	①外观无可见损伤痕迹; No visible mechanical damage. ②感量变化不超过±5%; Inductance shall not change more than ±5%; ③Q 值变化不超过±10%. Q shall not change more than±10%.	将电感器放置在于湿度 $90\% \sim 95\%$ , 温度 $60 \pm$ $+24$ $2^\circ\text{C}$ 的环境中存放 $1000 - 0$ h Inductors shall be subjected to $90\% \sim 95\% \text{RH}$ . $+24$ at $60 \pm 2^\circ\text{C}$ for $1000 - 0$ h
14	抗弯强度 Bending strength	外观无可见损伤痕迹; No visible mechanical damage.	①将电感器安装于试验基板上; 在垂直方向施加力(如下图所示)。Install the inductor on the test substrate; Apply force in the vertical direction (as shown below). ②该板应在 $(1 \pm 0.5)$ mm/s 的弯曲速率向下弯曲 2 mm, 保持时间 $\geq 5$ s。The epoxy plate should bend down to 2 mm at the bending rate of $(1 \pm 0.5)$ mm/s, Keep time $\geq 5$ sec. 单位为毫米 安装  试验 



序号 No.	项目 Items	要求 Requirements	试验方法及备注 Test Methods and Remarks
15	耐溶剂性 Solvent Resistance	①外观无可见损伤痕迹; No visible mechanical damage. ②感量变化不超过±5%; Inductance shall not change more than ±5%; ③Q 值变化不超过±10%. Q shall not change more than±10%.	将元件浸泡在 23±5℃ 的异丙醇溶液中, 保持 5±0.5 分钟。 Soak in the element 23±5℃ in isopropyl alcohol solution, keep 5±0.5 min.

注: 以上要求测试电性能的项目, 在室温下放置至少 2 h 后在 48 h 内进行测试。

Note: When there are questions concerning, test within 48 h after placing at room temperature for at least 2 h.

## 6 产品包装 Packaging

### 1) 编带图 Taping drawings

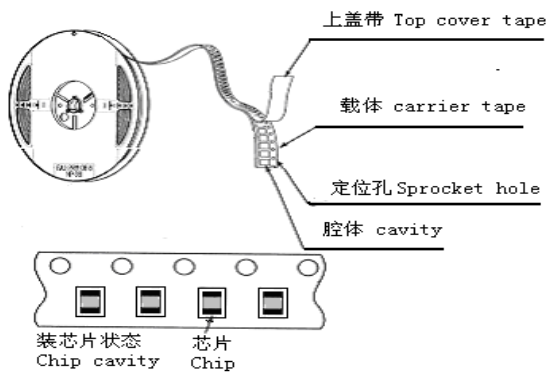

### 2) 卷盘尺寸 Reel dimensions (Unit:mm)

Part NO.	ΦA typ.	ΦB typ.	ΦC typ.	D typ.
0402-1210	178	60	13	8.4
1812	330	98	13	16.4

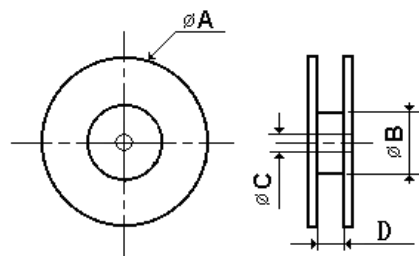

### 3) 导带及空格部分 Leader and blank portion

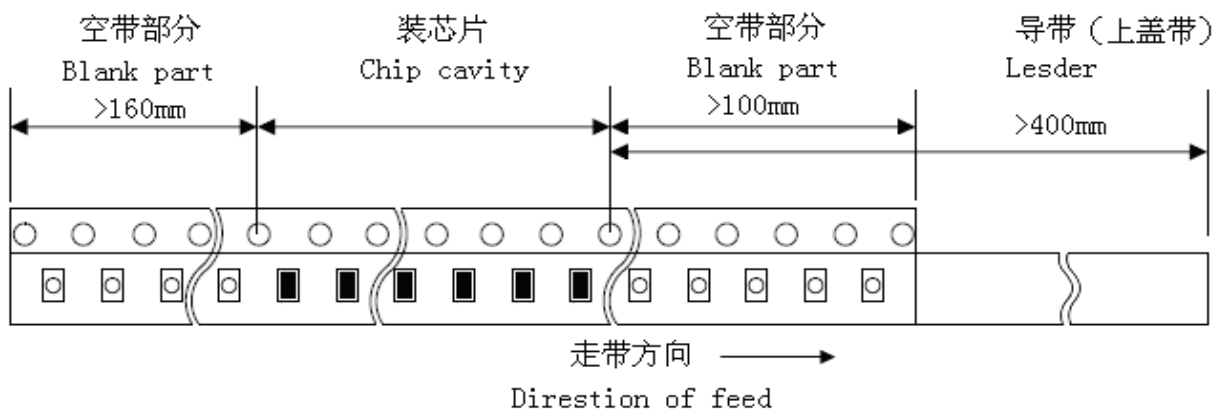



#### 4) 编带尺寸 Taping dimensions (Unit: mm)

- 纸带 Paper tape

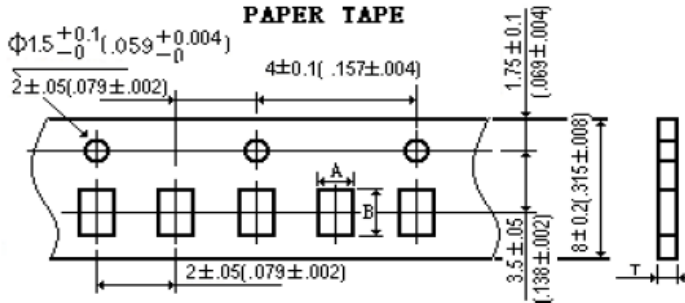

Part NO.	A	B	T
0402	0.74	1.23	0.60

- 塑料胶带 Embossed tape

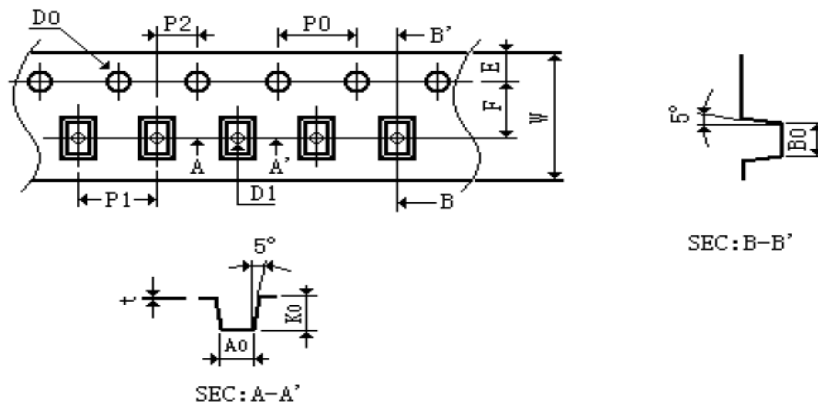

Part NO.	0603	0805	1008	1210	1812
W	8.00	8.00	8.00	8.00	12.00
E	1.75	1.75	1.75	1.75	1.75
F	3.50	3.50	3.50	3.50	5.50
D0	1.50	1.50	1.50	1.50	1.50
D1	0.50	0.65	0.65	0.65	1.50
P0	4.00	4.00	4.00	4.00	4.00
P1	4.00	4.00	4.00	4.00	8.00
P2	2.00	2.00	2.00	2.00	2.00
P0×10	40.00	40.00	40.00	40.00	40.00
t	0.23	0.23	0.25	0.23	0.25
A0	1.15	1.85	2.73	2.96	3.22
B0	1.85	2.45	2.90	3.60	4.82
K0	0.95	1.50	2.34	2.40	2.98

#### 5) 剥离力检验 Peeling off force

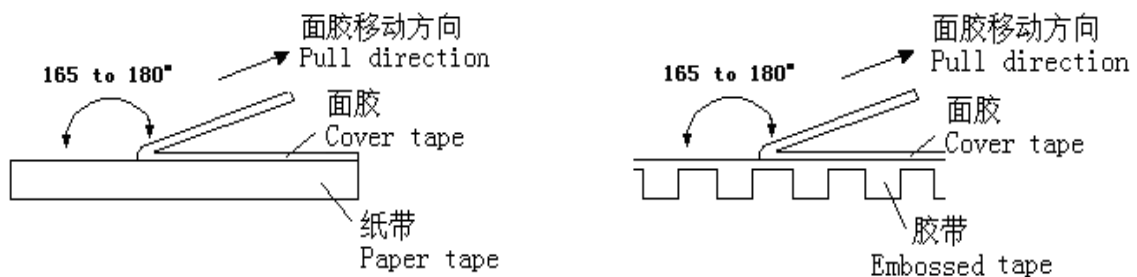



①盖带的剥离力要求 **Peeling required**

0402~1210 系列：20 克~80 克；1812 系列：20 克~100 克

0402~1210 series：20g~80g；1812 series: 20g~100g

②测试条件 **Test condition**

盖带剥离速度：300mm/min±10%

Speed of peeling off：300mm/min±10%

盖带剥离角度：165°~180°

Angle of peeling off: 165°~180°

6) 包装数量 (单位: 粒) **Packaging number (Unit: Pcs)**

类型 Size		1812	1210	1008	0805	0603	0402
每卷数量 Per Reel		2000	2000	2000	3000	4000	5000
每盒数量 Per Box	3 卷盒	-----	6000	6000	9000	12000	15000
	5 卷盒	10000	10000	10000	15000	20000	25000
	10 卷盒	-----	20000	20000	30000	40000	50000
每箱数量 Per Case	1.5 盒箱	-----	30000	30000	45000	60000	75000
	3 盒箱	-----	60000	60000	90000	120000	150000
	4 盒箱	-----	80000	80000	120000	160000	200000
	5 盒箱	-----	120000	120000	180000	240000	300000
	大 3 盒箱	30000	-----	-----	-----	-----	-----

7) 标签粘贴位置 **Label stick station**

卷盘标签 Reel label	纸盒标签 Carton label	纸盒标签 Carton label	外箱标签 Outer box label
			

## 7 推荐焊接条件 **Recommend Soldering Conditions**

1) 焊接条件 **Soldering Conditions**

本产品建议使用回流焊接法。

Applicable soldering process to the products is reflow soldering.

① 焊剂要求 **Flux, Solder**

- 使用松香基助焊剂，禁止使用卤化物含量超过 0.2(wt)%的强酸性助焊剂。

Don't use highly acidic flux with halide content exceeding 0.2(wt)%(chlorine conversion value).

- 使用无铅焊料 (96.5Sn /3.0Ag/0.5Cu)。

Using lead-free solder (96.5Sn /3.0Ag/0.5Cu)。

② 焊接要求 **Soldering conditions**

- 预热时，产品表温与焊料温度的温差最大不允许超出 150℃，焊接完冷却时，产品表温与溶剂温度之间的温差最大不超过 100℃。预热不足有可能引发产品表面裂纹，从而导致产品品质下降。

Pre-heating should be in such a way that the temperature difference between solder and ferrite surface is limited to 150℃ max. Also cooling into solvent after soldering should be in such way



that the temperature difference is limited to 100°C max. Un-enough pre-heating may cause cracks on the ferrite, resulting in the deterioration of product quality.

- 产品要在以下画出的曲线允许的范围进行焊接。其它焊接条件可能引起产品电极的腐蚀。当焊接重复时，允许的时间为第一次做的累计时间。

Products should be soldered within the following allowable range indicated by the slanted line. The excessive soldering conditions may cause the corrosion of the electrode. When soldering is repeated, allowable time is the accumulated time.

## 2) 回流焊曲线 Reflow soldering profile

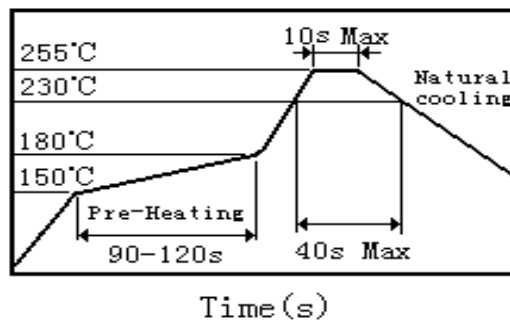

## 3) 手工焊接 Iron soldering

烙铁温度：350°C (Max)

功率：最大为 30W

烙铁停留时间：<5S (注意不要将烙铁碰到产品线圈及包封层)。

Perform soldering at 350°C on 30W max.

Soldering Time: < 5S (Take care not to apply the tip of the soldering iron to the terminal electrodes)。



# 8 清洗 Cleaning

## 1) 清洗条件 Cleaning Conditions

- 清洗温度：60°C (Max)      Cleaning temperature : 60°C max.
- 清洗时间：5 分钟 (Max)      Cleaning time: 5 minutes Max.
- 超声波功率：最大为 200W      Ultrasonic output power: 200W max.

# 9 存储要求 Storage Requirements

## 1) 存储期限 Storage period

距电感公司出厂检验时间 6 个月内，产品可以使用检验时间可以通过包装外侧标记的检验号确认。若时间超过 6 个月，应检查焊接性能后方可使用。

Products which inspected in INDUCTOR COMPANY over 6 months ago should be examined and used, which can be Confirmed with inspection No. marked on the container. Solder ability should be checked if this period is exceeded.



## 2) 存储条件 Storage conditions

- (1) 存放货物的库房应满足以下条件：温度：-10 ~ +40℃，相对湿度：30 ~ 70%。
- (2) 禁止将产品保管在腐蚀性物质中，如硫磺、氯气或酸，否则将引起端头氧化，导致降低焊接性。
- (3) 为了避免受潮气、灰尘等物质的影响，产品应保管于货架上。
- (4) 产品保管在库房中，应避免热冲击、振动以及直接光照等等。
- (5) 产品应密封包装。

- (1) Products should be storage in the warehouse on the following conditions:

Temperature : -10~+40°C      Humidity: 30~70% relative humidity

- (2) Don't keep products in corrosive gases such as sulfur, chlorine gas or acid , or it may case oxidization of Electrodes resulting in poor solder ability.
- (3) Products should be stored on the palette for the prevention of the influence from humidity, dust and so on.
- (4) Products should be stored in the warehouse without heat shock, vibration, direct sunlight and so on.
- (5) Products should be stored under the airtight packaged condition.

## 10 ODS（消耗臭氧层物质）的使用情况 Usage Of ODS

对于以下所列物质，我公司在生产过程中绝不使用。

ODS: CCl<sub>4</sub>（四氯化碳）、HCFC 等。

For ODS listed below , we don't use in process.

ODS: CCl<sub>4</sub>, HCFC, etc.

## 11 注意事项 Notes

- (1) RoHS 指令 Response to RoHS directive

本公司产品符合 RoHS 指令。

Our products are RoHS compliance.

- (2) 本承认书保证我司产品作为一个单体时的质量情况，当我司产品被安装到贵公司产品上时请保证贵司的产品已根据贵司的规范进行了有效评价和确认。

This product specification guarantees the quality of our product as a single unit, Please make sure that your product has been evaluated and confirmed against your specifications when our product is mounted to your product.

- (3) 如果贵司对我司产品的试用已超过了本测试规范所界定的产品功能，对于此所引发的失效我司将不予保证。

We can't warrant against failure caused by any use of our product that deviates from the intended use as described in this product specification.

- (4) 为防止断线，请不要使用锋利的物体接触线圈，如镊子。

Do not touch wire with sharp objects such as tweezers to prevent wire breakage.