

SMD ■ B

66-213UTD/S426/5C(AP)

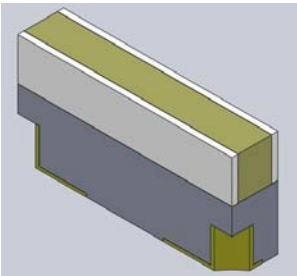

Features

- Package in 8mm tape on 7" diameter reel.
- Compatible with automatic placement equipment.
- Compatible with infrared and vapor phase reflow solder process.
- Mono-color type.
- Pb-free.
- Compliance with EU REACH.
- Compliance Halogen Free .(Br <900 ppm ,Cl <900 ppm , Br+Cl < 1500 ppm).
- The product itself will remain within RoHS compliant version.
- Moisture Sensitivity Level: 3

Description

- The 66-213 SMD LED is much smaller than lead frame type components, thus enable smaller board size, higher packing density, reduced storage space and finally smaller equipment to be obtained.
- Besides, lightweight makes them ideal for miniature applications. etc.

Applications

- Telecommunication: indicator and backlighting in telephone and fax.
- Keyboard, switch and symbol.
- General use.

Device Selection Guide

Chip Materials	Emitted Color	Resin Color
InGaN	Pure White	Yellow Diffused

Absolute Maximum Ratings (Ta=25°C)

Parameter	Symbol	Rating	Unit
Reverse Voltage	V _R	5	V
Forward Current	I _F	10	mA
Peak Forward Current (Duty 1/10 @1KHz)	I _{FP}	50	mA
Power Dissipation	P _d	32	mW
Electrostatic Discharge	ESD _{HBM}	2000	V
Operating Temperature	T _{opr}	-30 ~ +85	°C
Storage Temperature	T _{stg}	-40 ~ +100	°C
Soldering Temperature	T _{sol}	Reflow Soldering : 260 °C for 30 sec. Hand Soldering : 350 °C for 3 sec.	

Electro-Optical Characteristics (Ta=25°C)

Parameter	Symbol	Min.	Typ.	Max.	Unit	Condition
Luminous Intensity ^{*1}	I _v	300	350	400	mcd	
Luminous Flux(reference only)	Φ _v	0.95	1.10	1.27	lm	
Blue peak wavelength	λ _p	443	448	453	nm	
bottom view Angle(Bottom View)	2θ _{1/2}	----	120	----	deg	I _F =5mA
Color over angle(0deg~8 0deg)	Δ u'v'	----	----	0.050	----	
Forward Voltage ^{*2}	V _F	2.40	2.80	3.15	V	
Reverse Current	I _R	----	----	2.0	μA	V _R =5V
Lifetime ^{*3}	----	10,000	----	----	hour	I _F =5mA

Note:

1. Tolerance of Luminous Intensity: ±10%
2. Tolerance of Forward Voltage: ±0.1V
3. Lifetime is estimated time to luminous flux L70B1 base on accelerating life test.

Chromaticity Coordinates Specifications for Bin Grading

Bin Code		CIE				Condition
F1	X	0.2711	0.2679	0.2715	0.2746	I _F =5mA
	Y	0.2250	0.2399	0.2465	0.2314	
F2	X	0.2679	0.2648	0.2683	0.2715	
	Y	0.2399	0.2548	0.2615	0.2465	
G1	X	0.2746	0.2715	0.2750	0.2781	
	Y	0.2314	0.2465	0.2529	0.2378	
G2	X	0.2715	0.2683	0.2719	0.2750	
	Y	0.2465	0.2615	0.2680	0.2529	
H1	X	0.2781	0.2750	0.2785	0.2816	
	Y	0.2378	0.2529	0.2593	0.2442	
H2	X	0.2750	0.2719	0.2754	0.2785	
	Y	0.2529	0.2680	0.2744	0.2593	
J1	X	0.2816	0.2785	0.2820	0.2851	
	Y	0.2442	0.2593	0.2657	0.2506	
J2	X	0.2785	0.2754	0.2789	0.2820	
	Y	0.2593	0.2744	0.2808	0.2657	

- Notes:
- 1.The C.I.E. 1931 chromaticity diagram (Tolerance ± 0.01).
 - 2.The products are sensitive to static electricity and care must be fully taken when handling products.

CIE Chromaticity Diagram

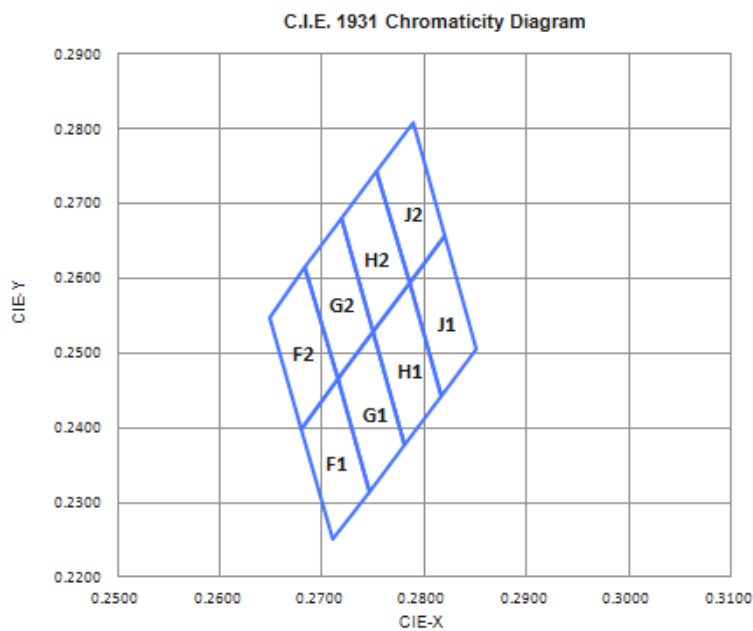

Typical Electro-Optical Characteristics Curves

Spectral power distribution

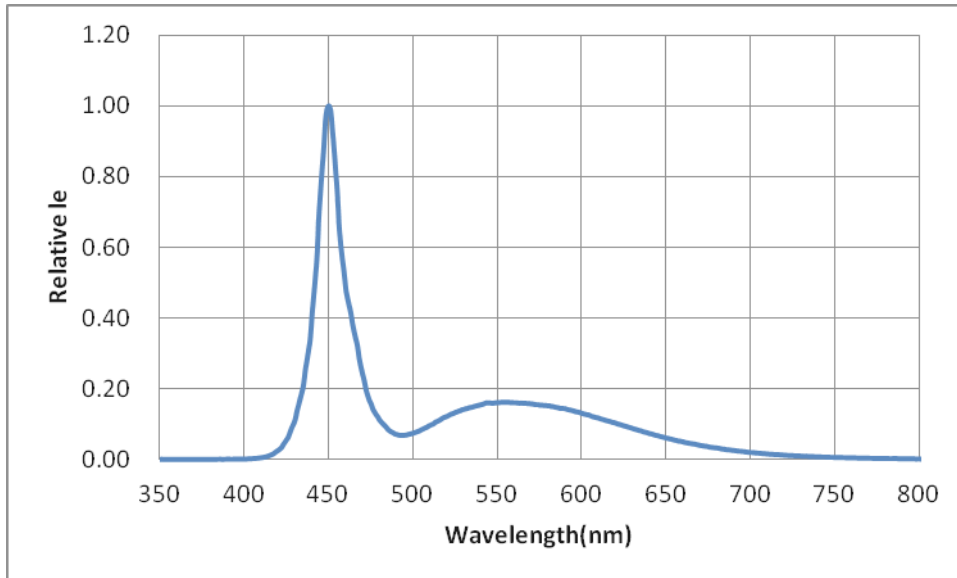

Forward Current vs. Forward Voltage

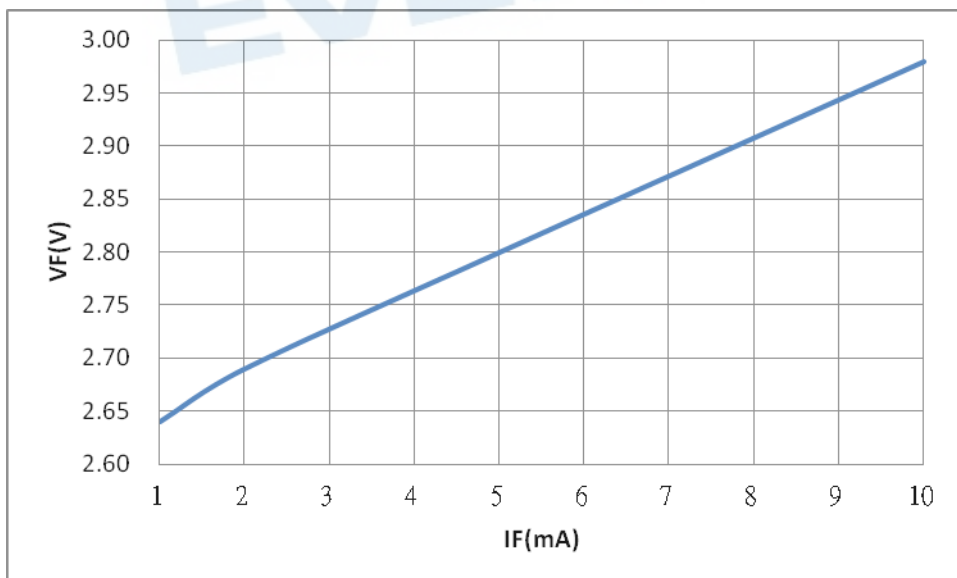

Ta vs. Forward Voltage

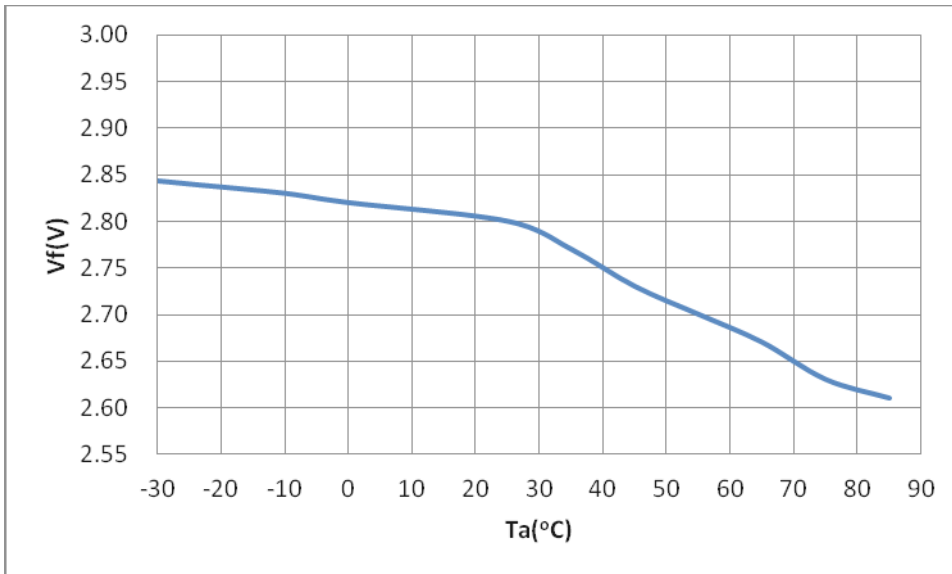

Forward Current vs. Relative Luminous Intensity

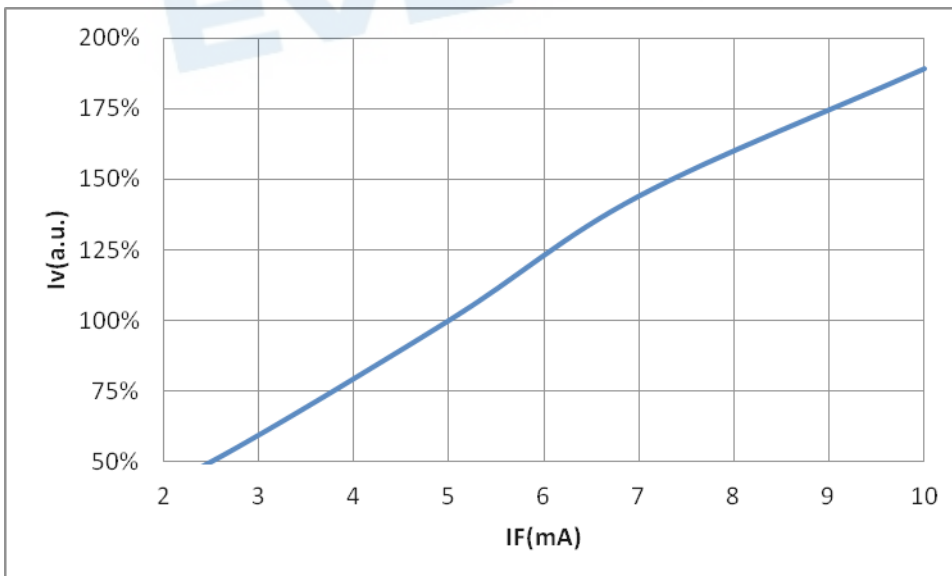

Forward Current vs. Chromaticity Coordinate

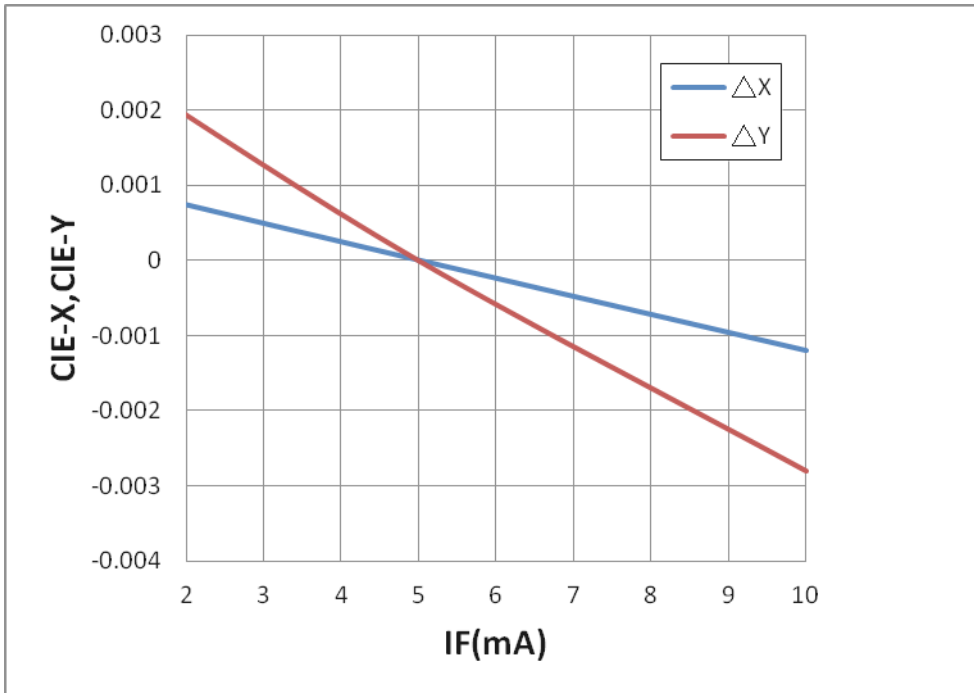

Case Temperature vs. Relative Luminous Intensity

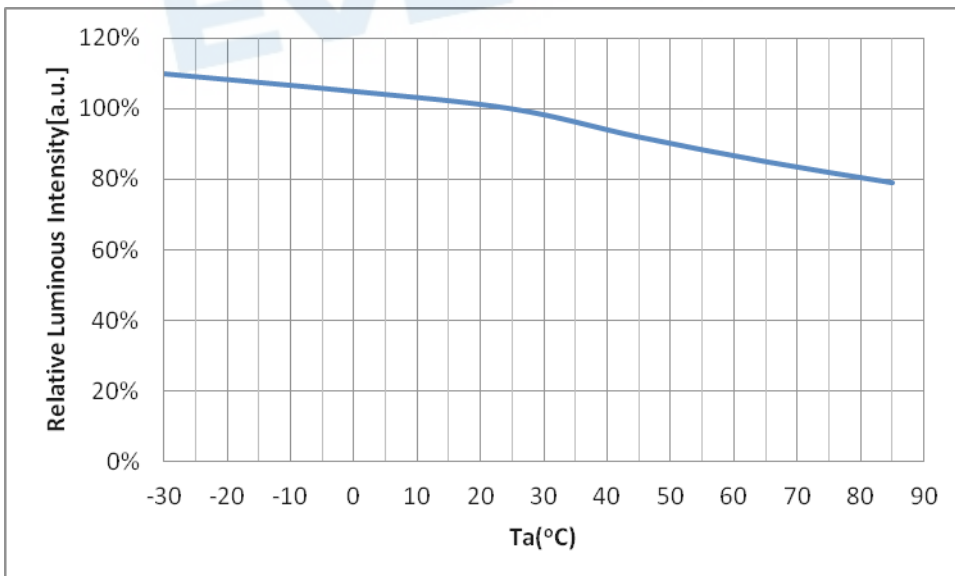

Ta vs. Chromaticity Coordinate

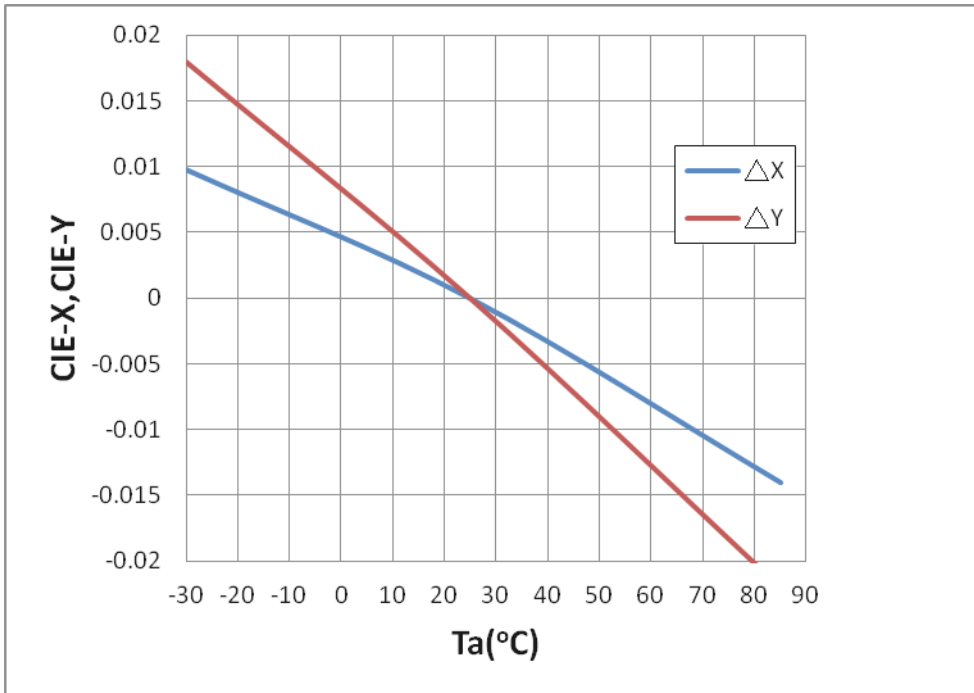

Forward Current Derating Curve

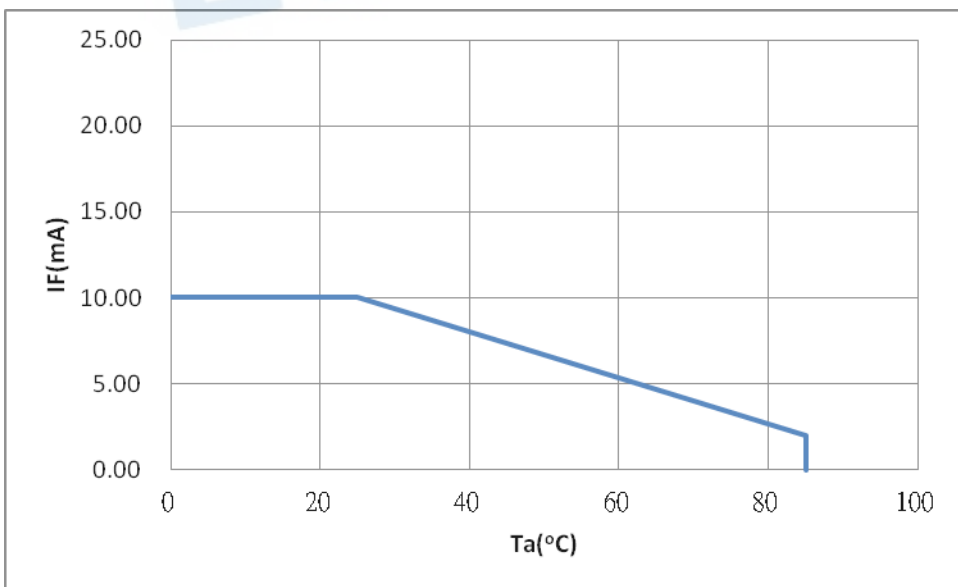

Radiation pattern

Side View

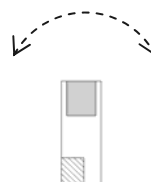
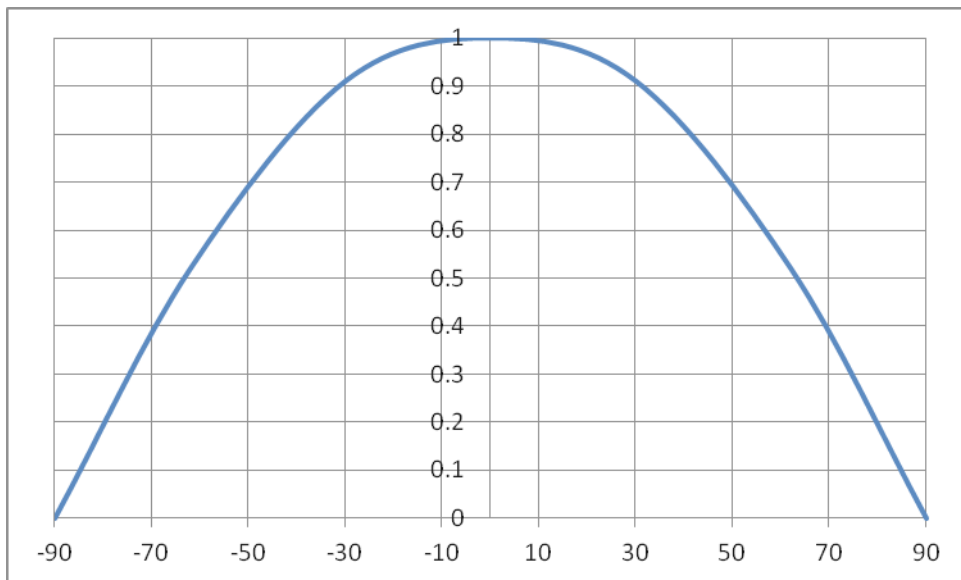

Bottom View

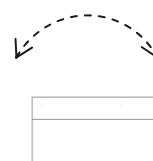
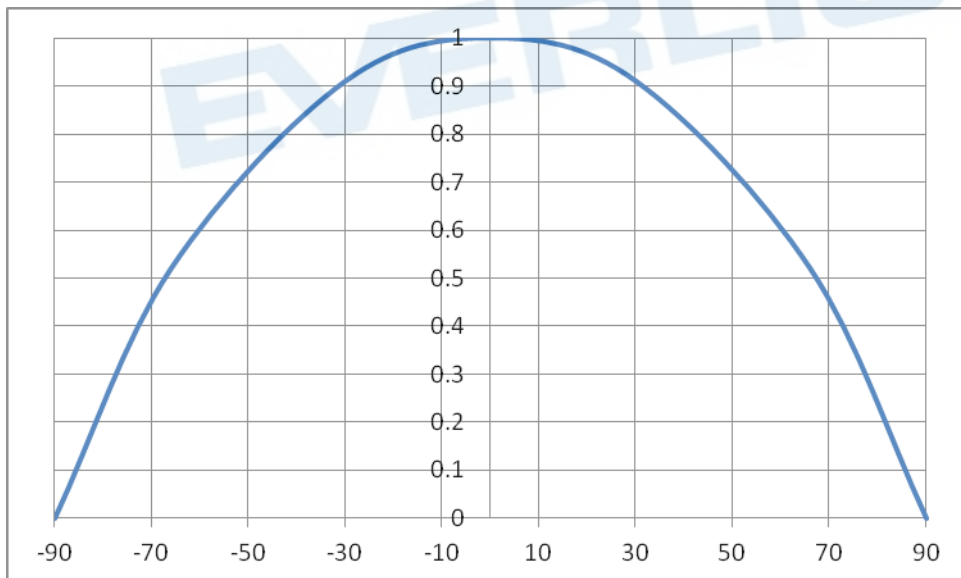

Side View

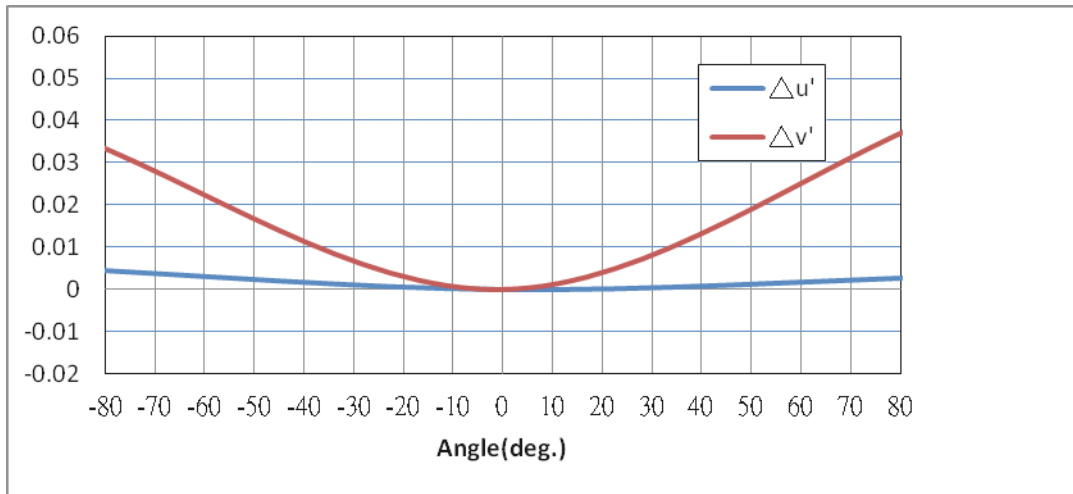

Bottom View

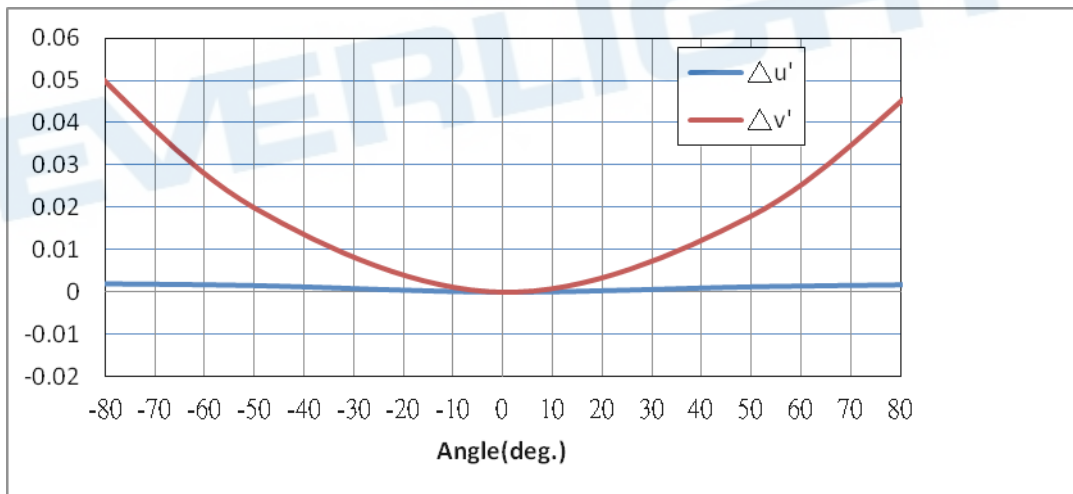

Package Dimension

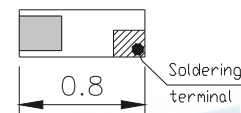
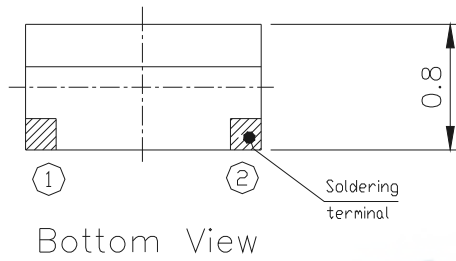
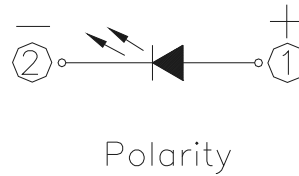
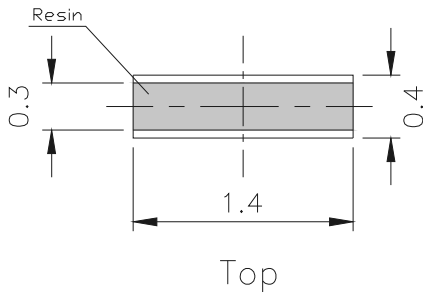

Customer Recommend soldering pad

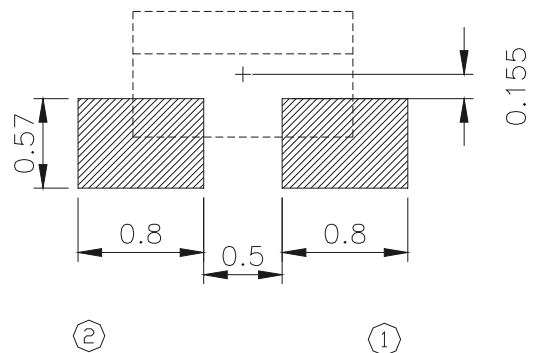
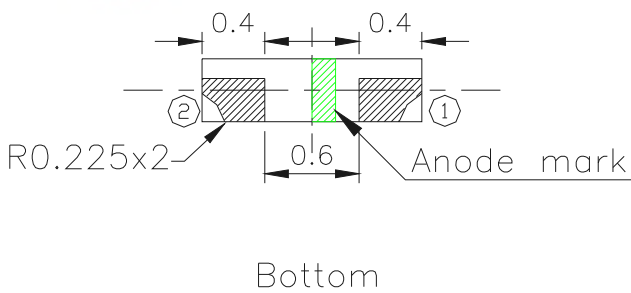

Suggested pad dimension is just for reference only.
Please modify the pad dimension based on individual need.

Note: Tolerances unless mentioned ± 0.1 mm. Unit = mm

Label Explanation

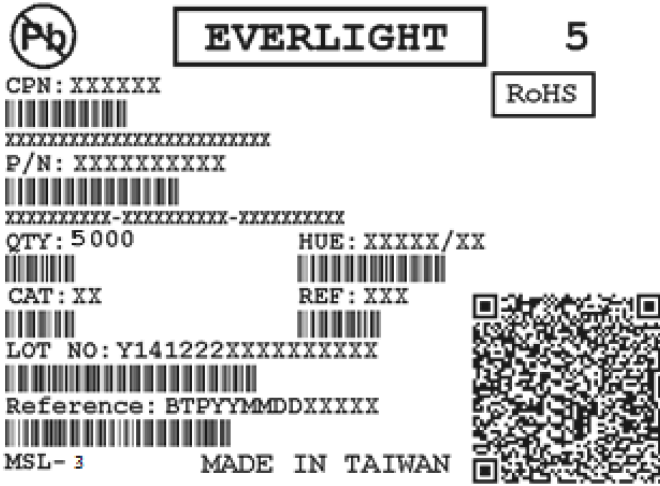

- CPN: Customer's Product Number
- P/N: Product Number
- QTY: Packing Quantity
- CAT: Luminous Intensity Rank
- HUE: Chromaticity Coordinates & Dom. Wavelength Rank
- REF: Forward Voltage Rank
- LOT No: Lot Number

Reel Dimensions

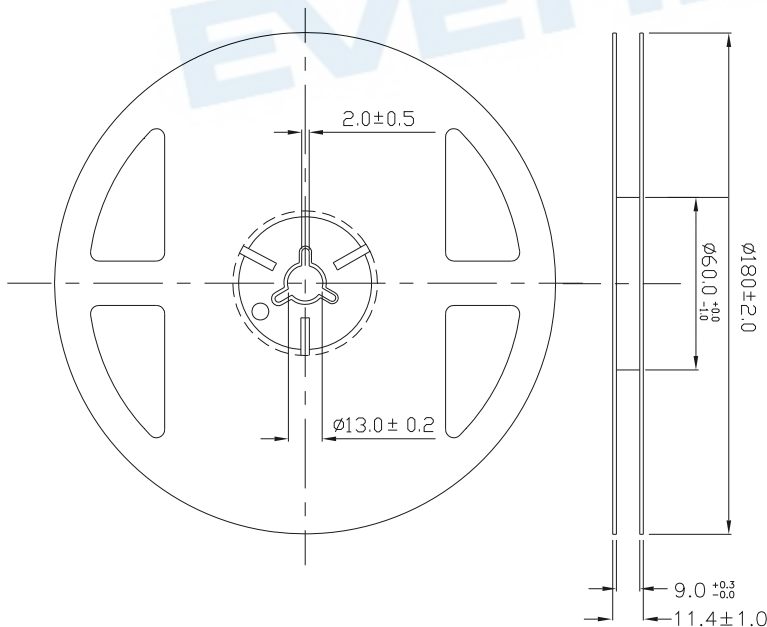

Note: The tolerances unless mentioned is $\pm 0.1\text{mm}$,Unit = mm

Carrier Tape Dimensions: Loaded quantity 5000 PCS per reel

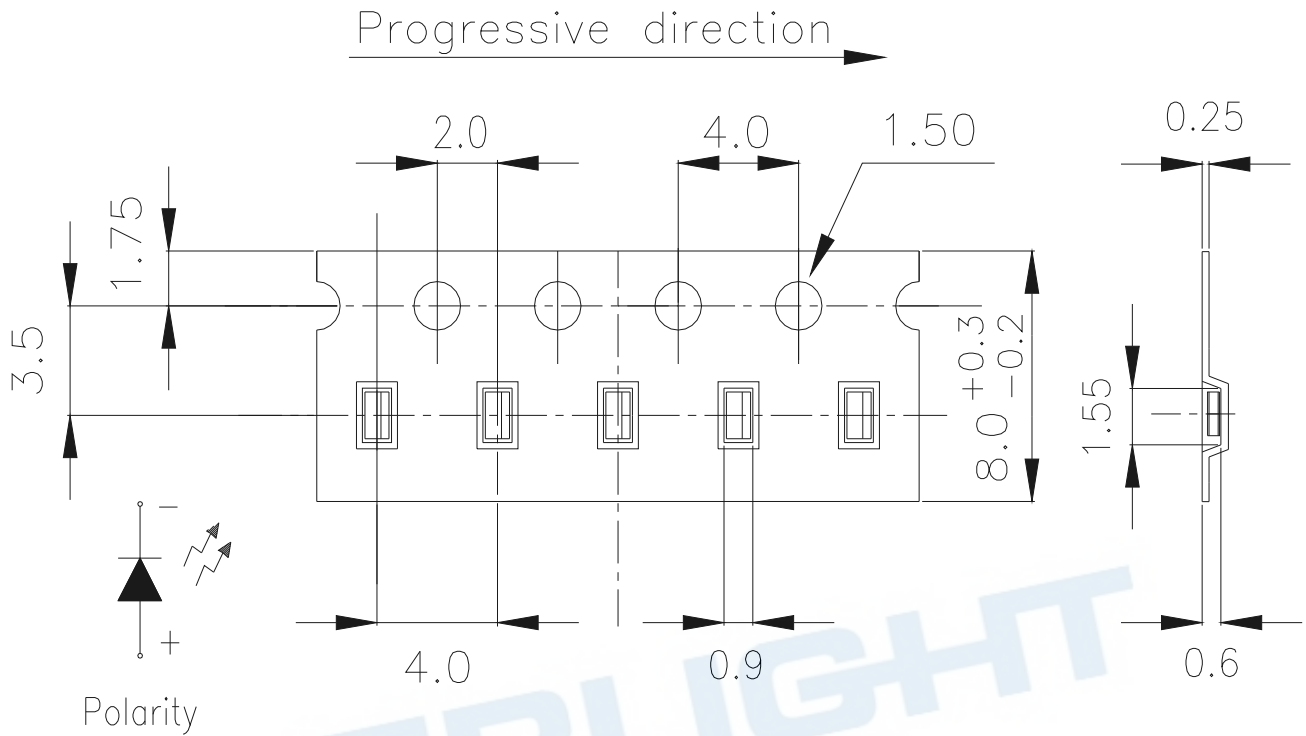

Note: The tolerances unless mentioned is $\pm 0.1\text{mm}$, Unit = mm

Moisture Resistant Packaging

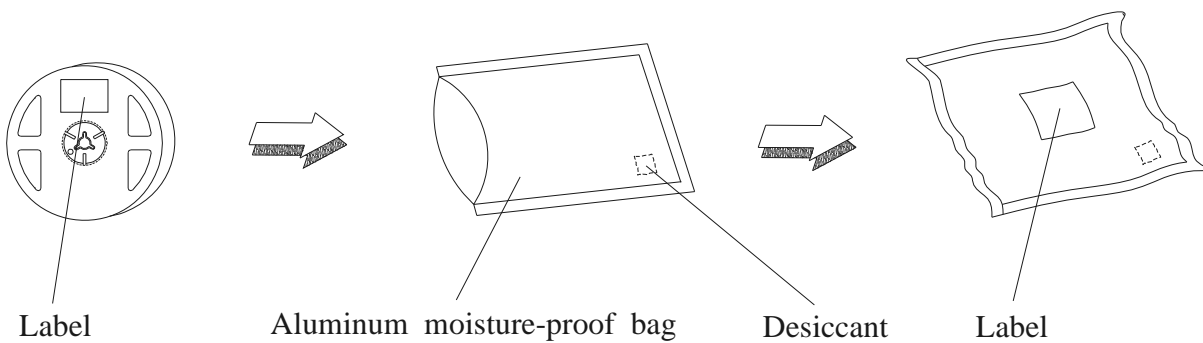

Precautions For Use

1. Over-current-proof

Customer must apply resistors for protection, otherwise slight voltage shift will cause big current change (Burn out will happen).

2. Storage

- 2.1 Do not open moisture proof bag before the products are ready to use.
- 2.2 Before opening the package: The LEDs should be kept at 30°C or less and 90%RH or less.
- 2.3 After opening the package: The LED's floor life is 168 hrs under 30°C or less and 60% RH or less.

If unused LEDs remain, it should be stored in moisture proof packages.

2.4 If the moisture absorbent material (silica gel) has faded away or the LEDs have exceeded the storage time, baking treatment should be performed using the following conditions.

Baking treatment : 60±5°C for 24 hours.

3. Soldering Condition

3.1 Pb-free solder temperature profile

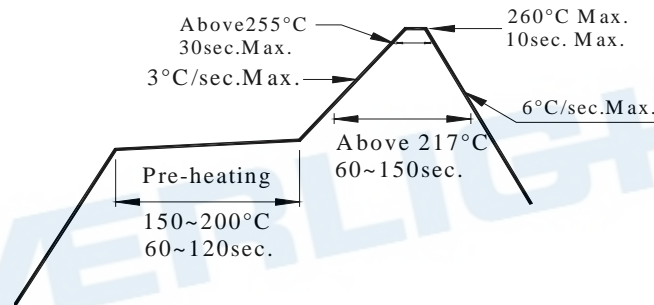

3.2 Reflow soldering should not be done more than two times.

3.3 When soldering, do not put stress on the LEDs during heating.

3.4 After soldering, do not warp the circuit board.

4. Soldering Iron

Each terminal is to go to the tip of soldering iron temperature less than 350°C for 3 seconds within once in less than the soldering iron capacity 25W. Leave two seconds and more intervals, and do soldering of each terminal. Be careful because the damage of the product is often started at the time of the hand solder.

5. Repairing

Repair should not be done after the LEDs have been soldered. When repairing is unavoidable, a double-head soldering iron should be used (as below figure). It should be confirmed beforehand whether the characteristics of the LEDs will or will not be damaged by repairing.

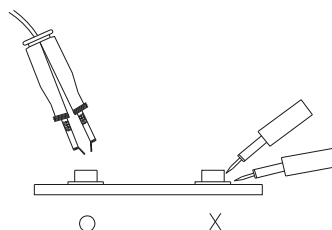

Application Restrictions

High reliability applications such as military/aerospace, automotive safety/security systems, and medical equipment may require different product. If you have any concerns, please contact Everlight before using this product in your application. This specification guarantees the quality and performance of the product as an individual component. Do not use this product beyond the specification described in this document.

EVERLIGHT